

eCampus Biological Science 3D Modeling

ECAMPUS BIOLOGICAL SCIENCE 3D MODELING

PRANJAL SALONI AND SARAH STOKES

CONTENTS

Introduction	1
Acknowledgment	2
Part I. <u>Main Body</u>	
1. DNA Replication Bubble	5
2. DNA to RNA Translation	13
3. Chromosomes of Mitosis and Meiosis	20
Resources	29

INTRODUCTION

Brief summary

This project creates 3D printable models that instructors can use to illustrate lecture content, and students and teaching assistants can manipulate the models to better facilitate understanding of the physical space and relationships of biological systems, organs, and cells. It supports experiential learning for biological science courses and increases access to enhanced learning for diverse groups of students. In order to help learning in biological science courses, we will offer a library of 3D-printable files for significant biology models. These files can be used to both augment textbook content and improve hands-on learning in the lab.

Why was it developed?

Conventionally published textbooks offer various support materials, including test banks, illustrations, and teacher resources, but sometimes fall short in providing practical experiences. Since different learners process and understand information differently, it's critical for educators to provide instructional materials in a range of formats. This was considered when developing the project. Because 3D printed biological models give students many ways to engage, learn, and demonstrate their knowledge, they support Universal Design for Learning (UDL) in ways that many other resources do not. Additionally, the immersive quality of 3D printed models enhances the dynamic and participatory nature of learning as students become more involved in the learning process and engage numerous senses by interacting and investigating 3D printed biological models.

ACKNOWLEDGMENT

Authors

Sarah Stokes, Pranjal Saloni, Lidya Salim

Funding Acknowledgement

This resource is funded by the Government of Ontario. The views expressed in this publication are the views of the author(s) and do not necessarily reflect those of the Government of Ontario.

About the Open Education (OE) Lab

[Ontario Tech University](#) is proud to host the [OE Lab](#) – a student-run, staff-managed group that brings content and technological expertise to the timely **creation of high quality OER that will be used directly in an Ontario Tech course by Ontario Tech students.**



Caption: OER Equal Love

Thank you to the students employed by the OE Lab for working hard to make this project a reality!

Editors: Noopa Kuriakose, Zainab Nomani, Divya Sharma, Maria tifanny vera Martinez, Umer Bashir, Aalina Shahid, Ghufran Shahid

Project Managers: Pranjal Saloni, Sarah Stokes

How to Attribute This Work

Suggested Attribution for This Work: *[eCampus Biological Science 3D Modeling](#) produced by the [OE Lab](#) at [Ontario Tech University](#), 2024, licensed under a [CC BY NC SA 4.0 International License](#), unless otherwise noted.*



1.

DNA REPLICATION BUBBLE

Printable Files

Please find the 3D printable files [here](#).

[Design 1](#)

Reference Models

<https://sketchfab.com/3d-models/dna-replication-model-3122da8323374eb5bf9ed4736c0de563>

Images

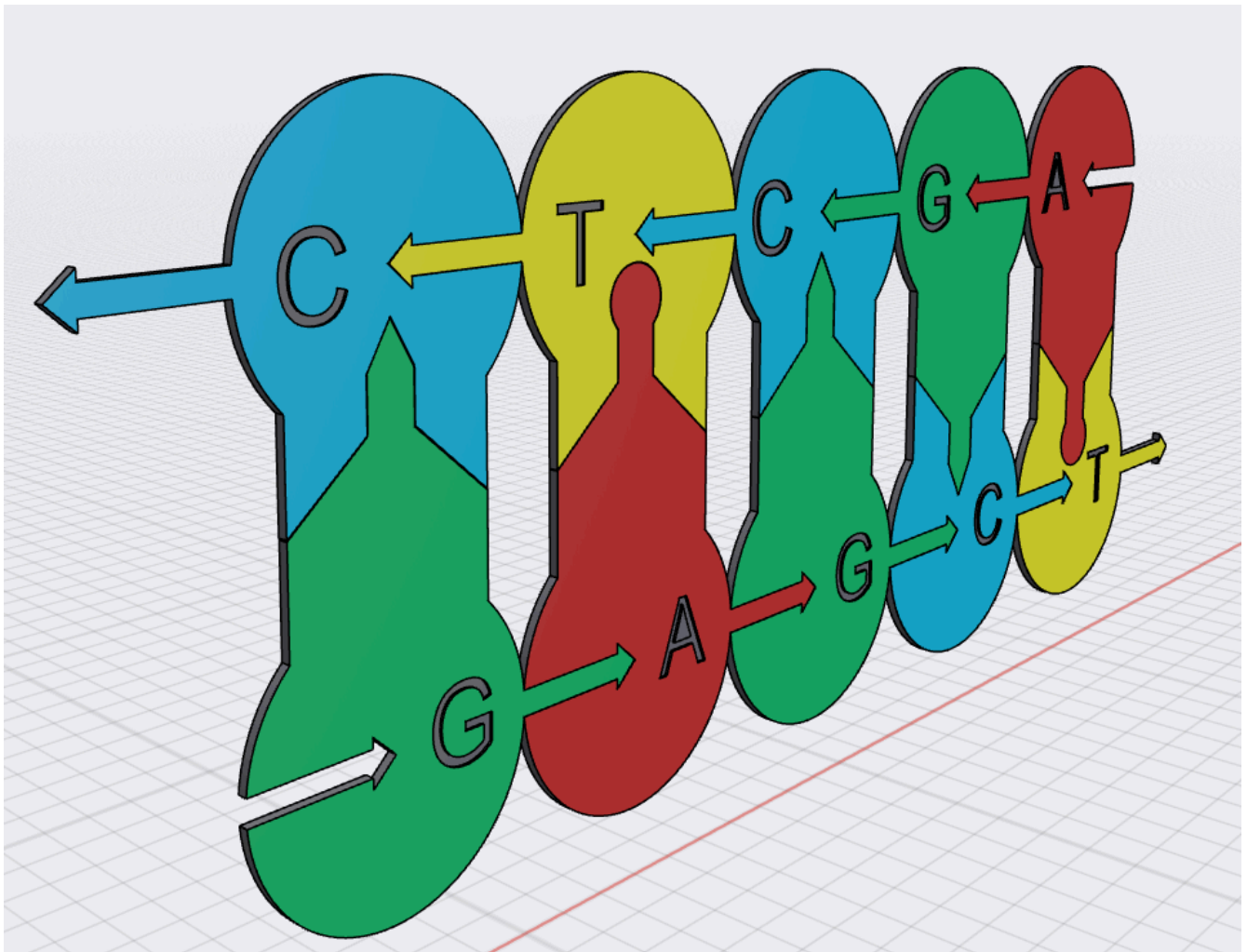

Front – side view of the DNA replication bubble

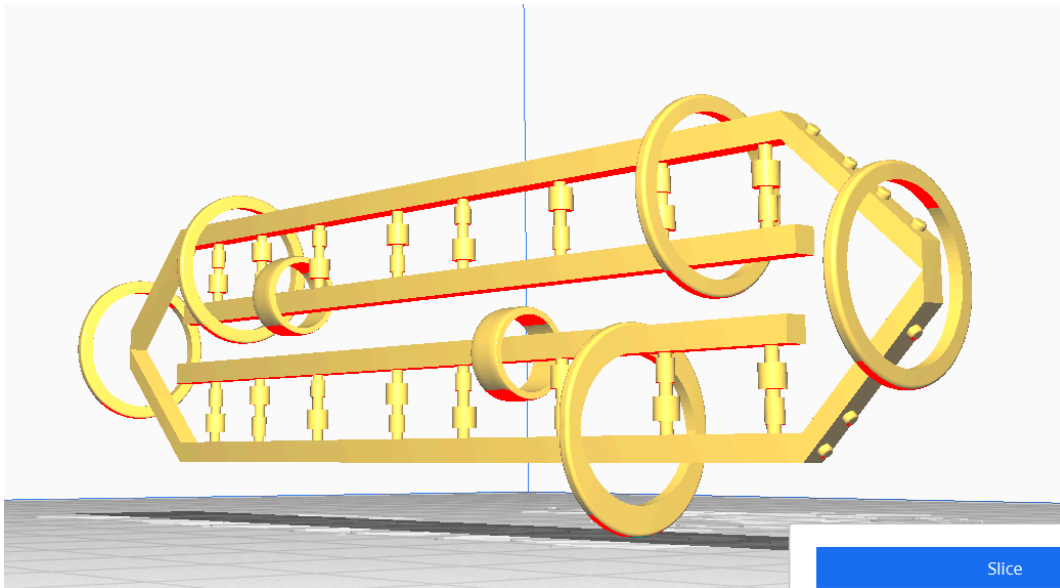

Back view of the DNA replication bubble model

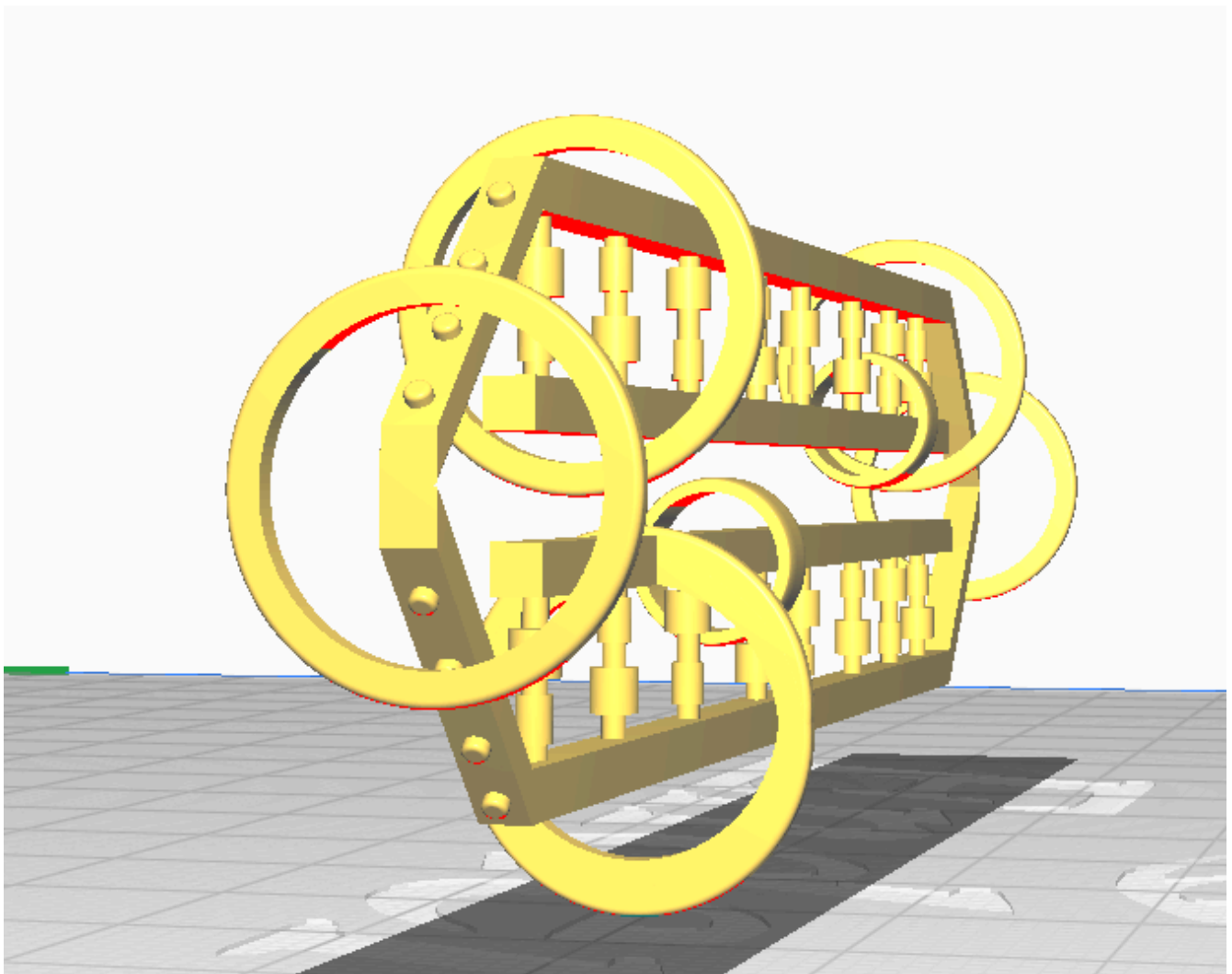

Side view of the DNA replication bubble model

Prototype

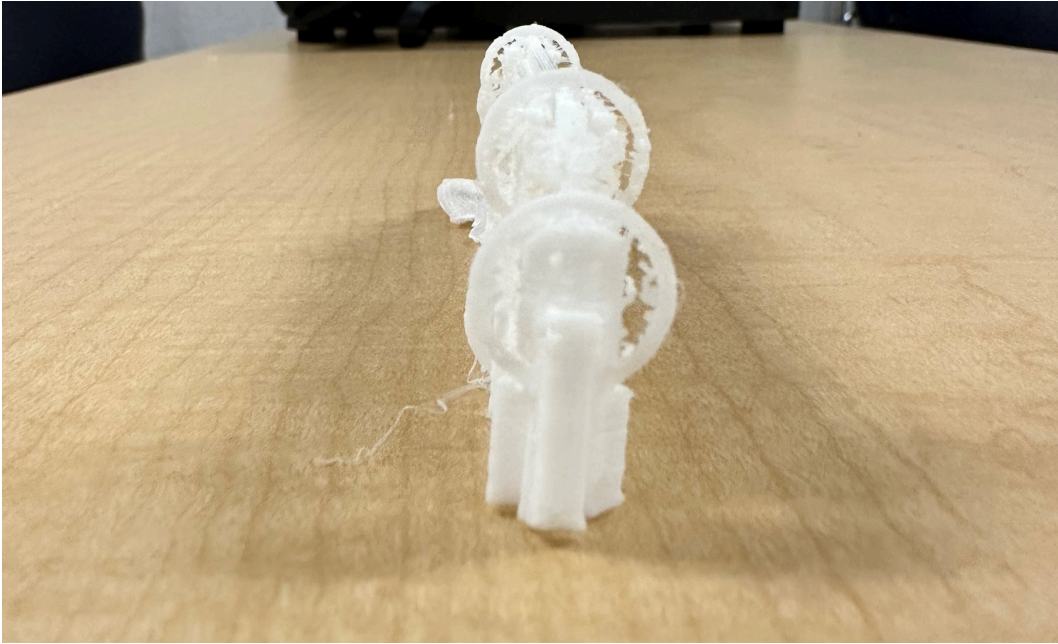

Printed prototype of DNA replication bubble from the side

Notes

- The model was printed using white PLA only. With coloured PLA, printed prototype should look similar to that in computer image.
- This model is a miniature prototype, hence some smaller details are unclear. Adjust the size of the model before printing for a much clearer model.
- Keep filament / PLA temperature above 250 degree Celsius.

[Design 2](#)

To print each part separately, please use [this link](#) to access separate part files.

Reference Model



One or more interactive elements has been excluded from this version of the text. You can view them online here: <https://ecampusontario.pressbooks.pub/biologicalscience3dmodelling/?p=25#oembed-1>

Images

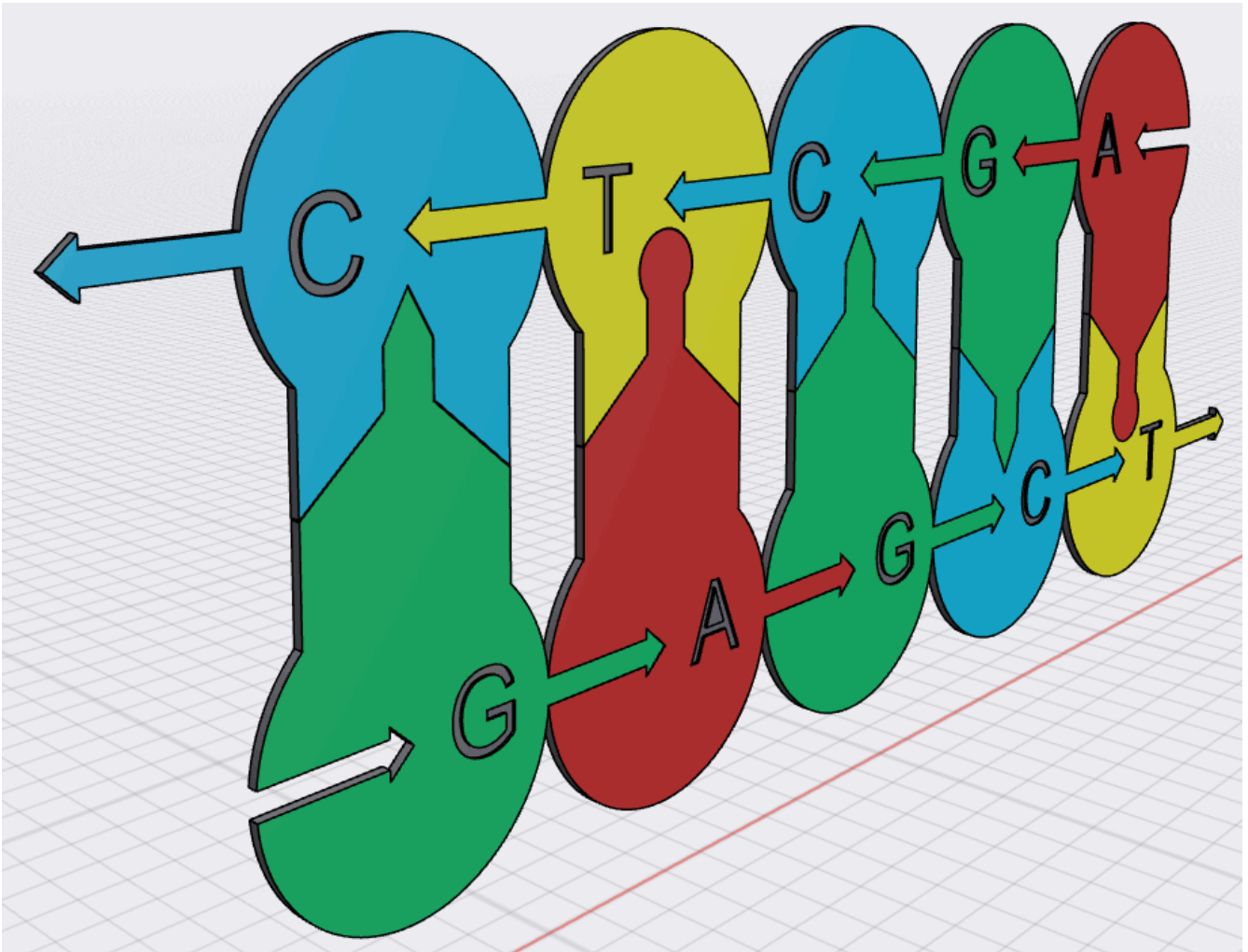

Front – side view of the DNA replication bubble

Prototype



3D printed front view of the DNA replication bubble

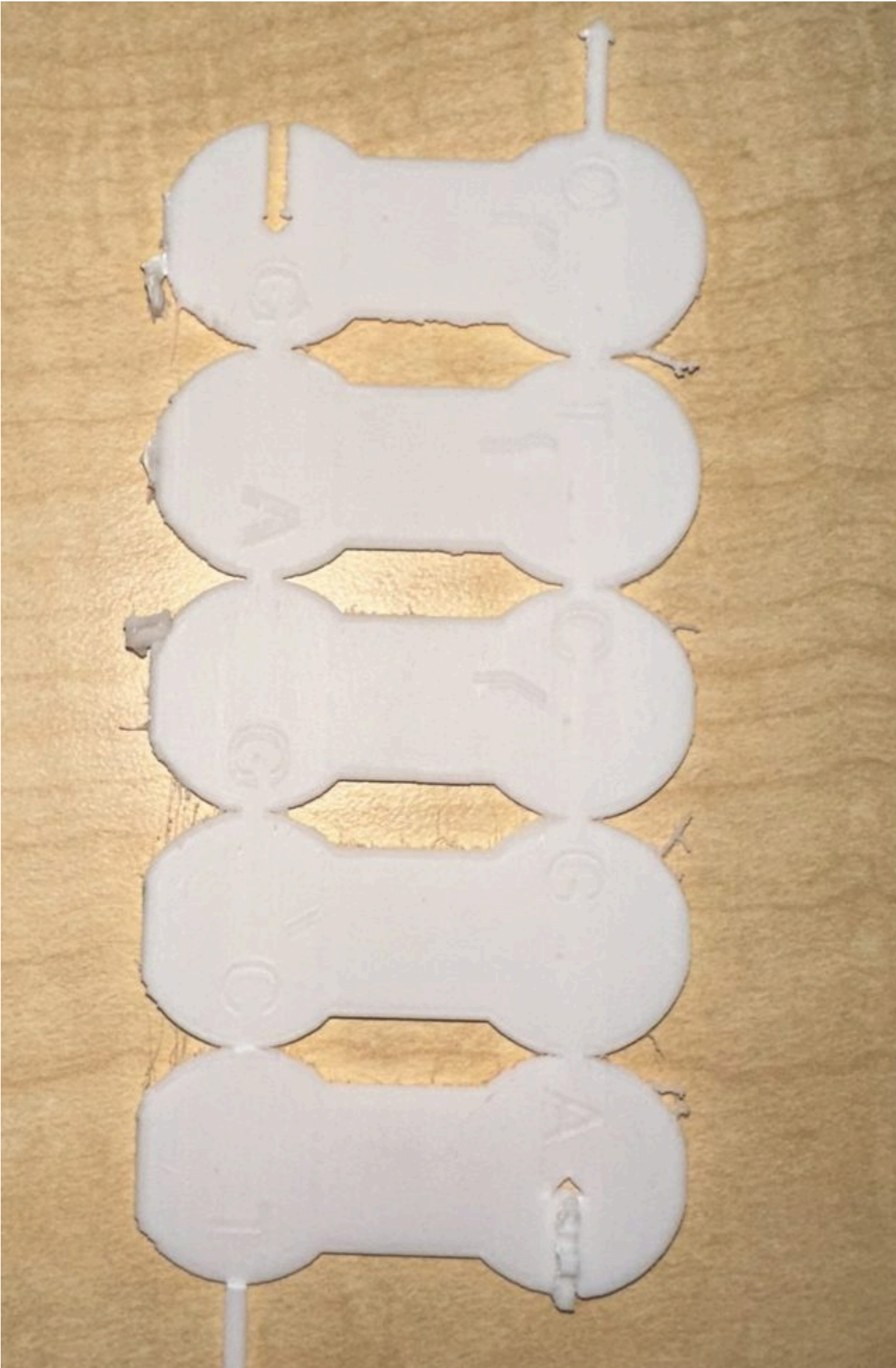

Top view of the 3D printed DNA replication bubble

Points to Note

- The model was printed using white PLA only. With coloured PLA, printed prototype should look similar to that in computer image.

2.

DNA TO RNA TRANSLATION

Printable Files

Please find the 3D printable files [here](#).

To print each part separately, please use [this link](#) to access separate part files.

Reference Models

<https://pinshape.com/items/33850-3d-printed-dnarna-building-settranscription-and-translation-model>

<https://www.printables.com/model/80861-dna-rna-manipulatives>

Images

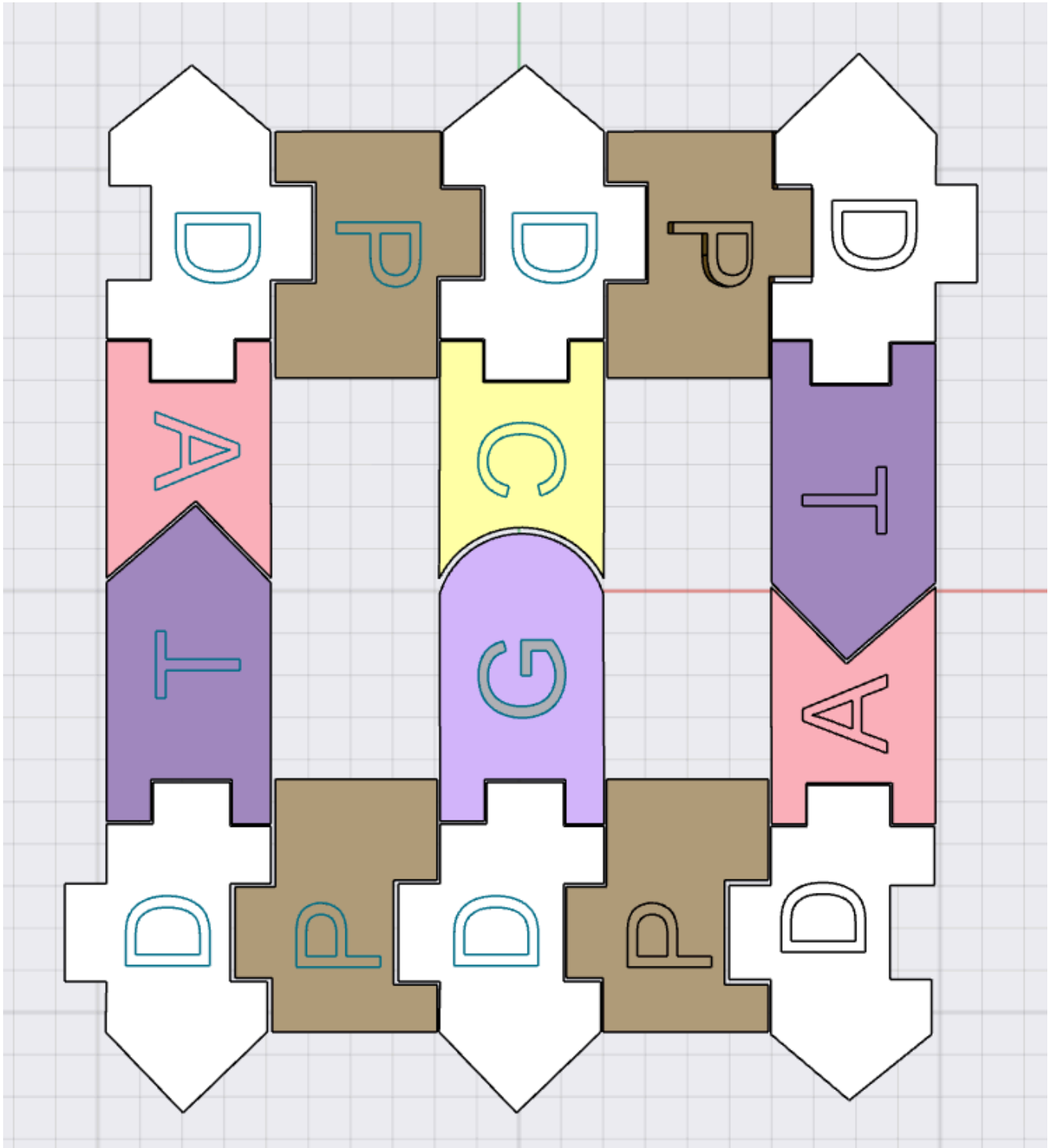

Top view of DNA to RNA translation

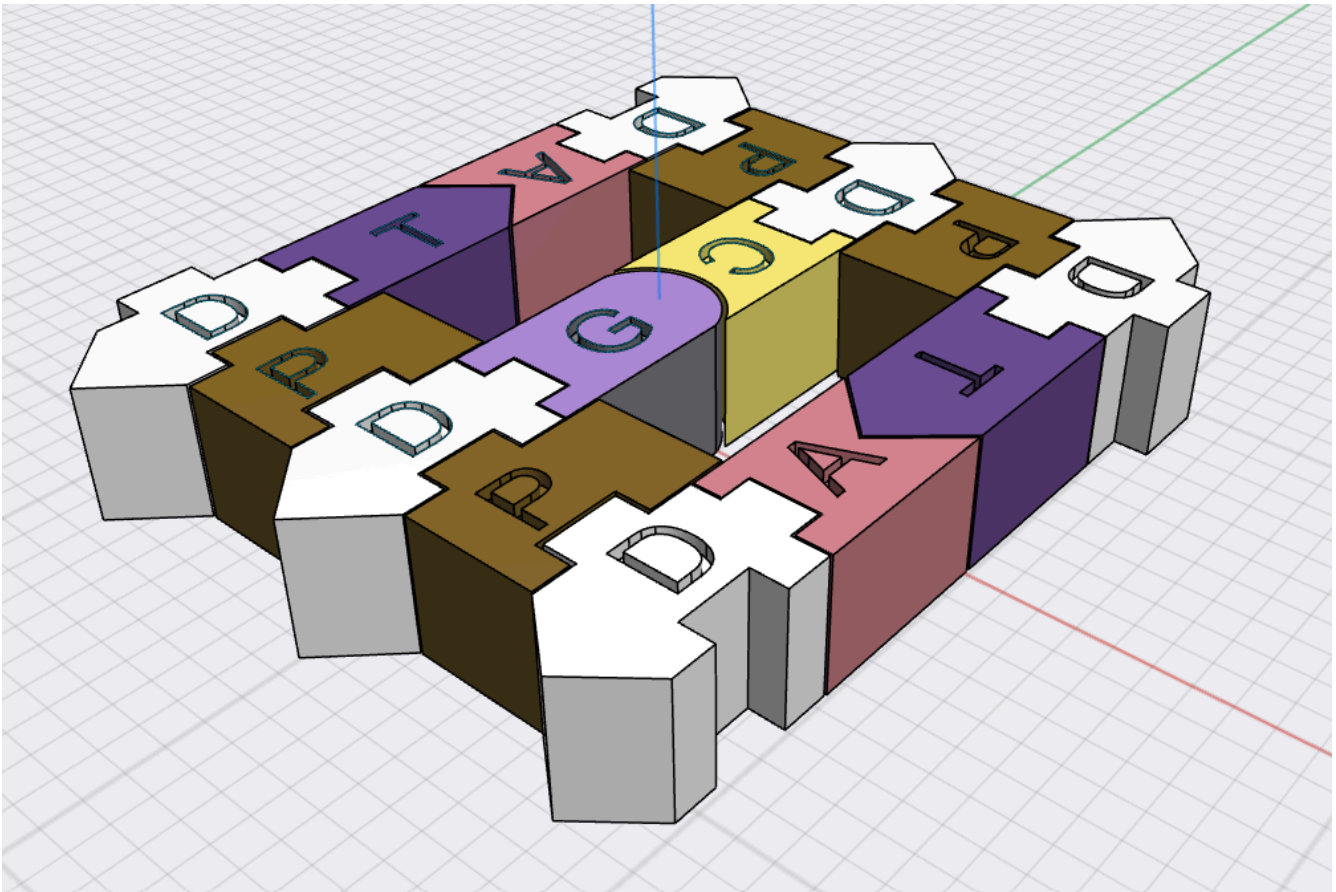

Side view of DNA to RNA translation from the top

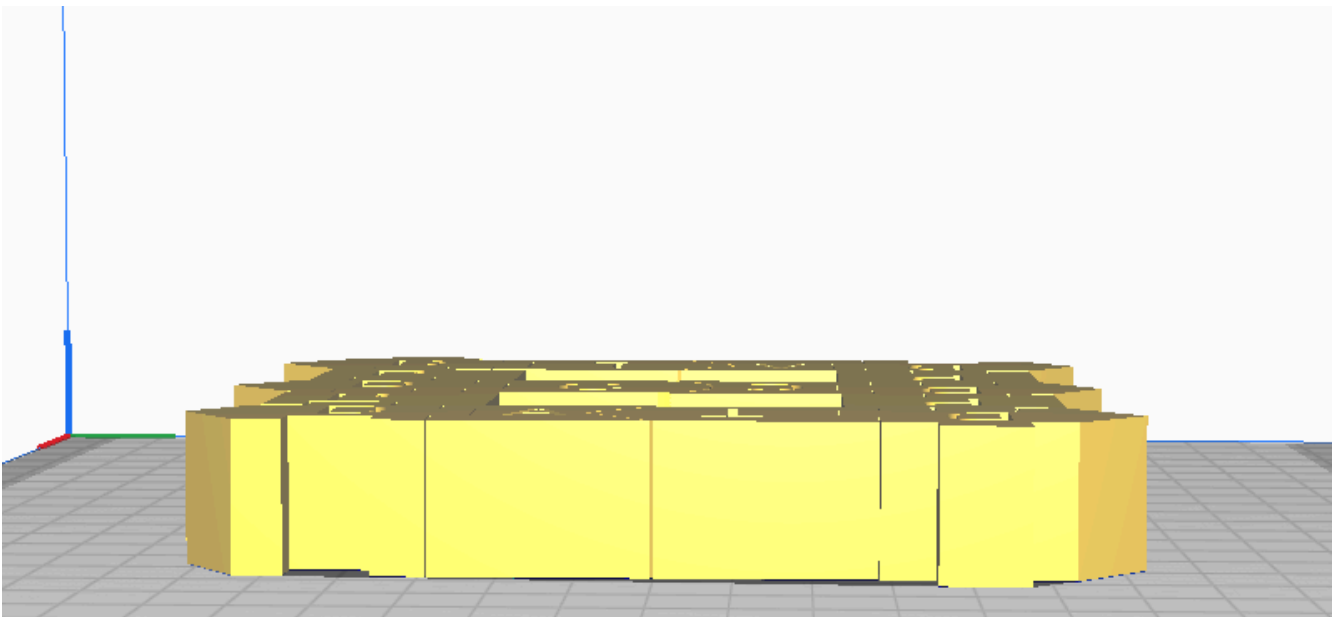

Side view of DNA to RNA translation

Prototype



Top view of the 3D printed DNA to RNA translation

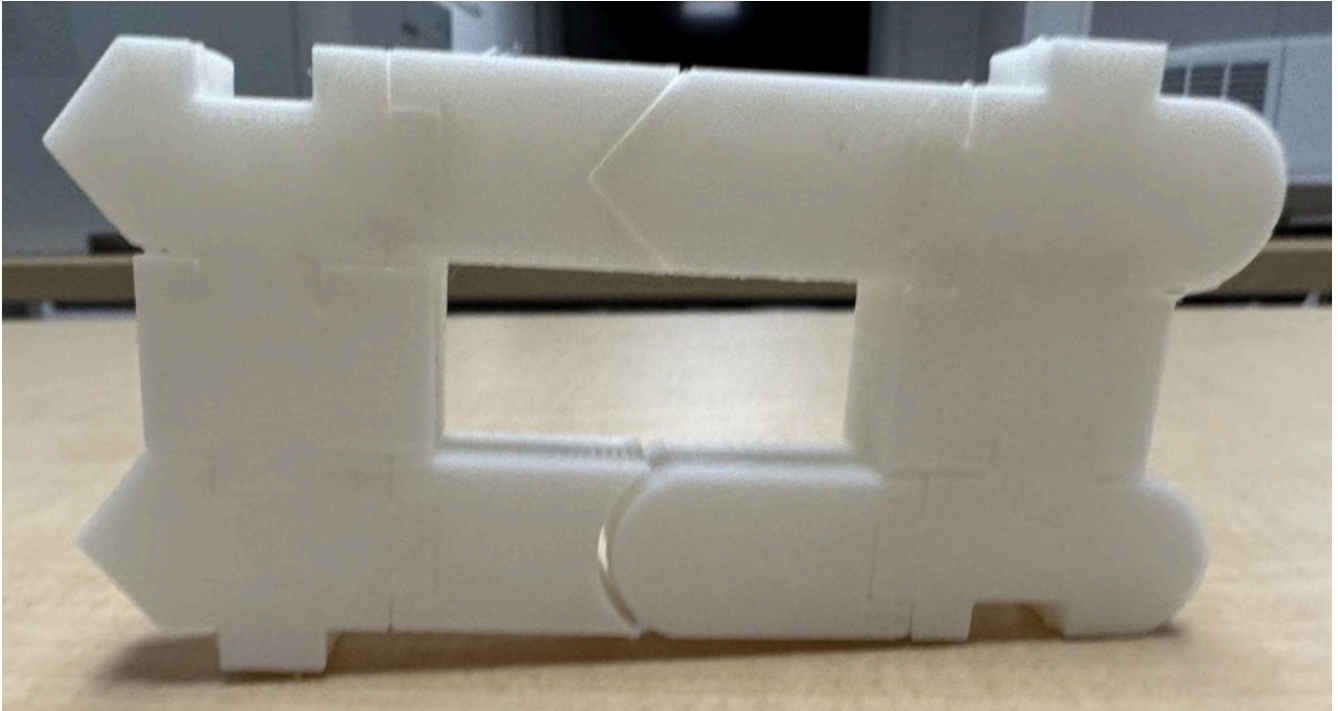

Front view of the 3D printed DNA to RNA translation



Side view of the 3D printed DNA to RNA translation from the top

Points to Note

- The model was printed using white PLA only. With coloured PLA, printed prototype should look

similar to that in computer image.

- The letters on the blocks were added in the second version after these pictures were taken. The final files have these updates so the models should look like the computer pictures above.
- This model can work as a “pull apart” model with different print settings.
- This model is a miniature prototype, hence only one row and column is shown.

3.

CHROMOSOMES OF MITOSIS AND MEIOSIS

Printable Files

Please find the 3D printable files [here](#).

To print each part separately, please use [this link](#) to access separate part files.

Reference Model

https://commons.wikimedia.org/wiki/File:Chromosomes_3D_printed_and_mietosis.jpg

Images

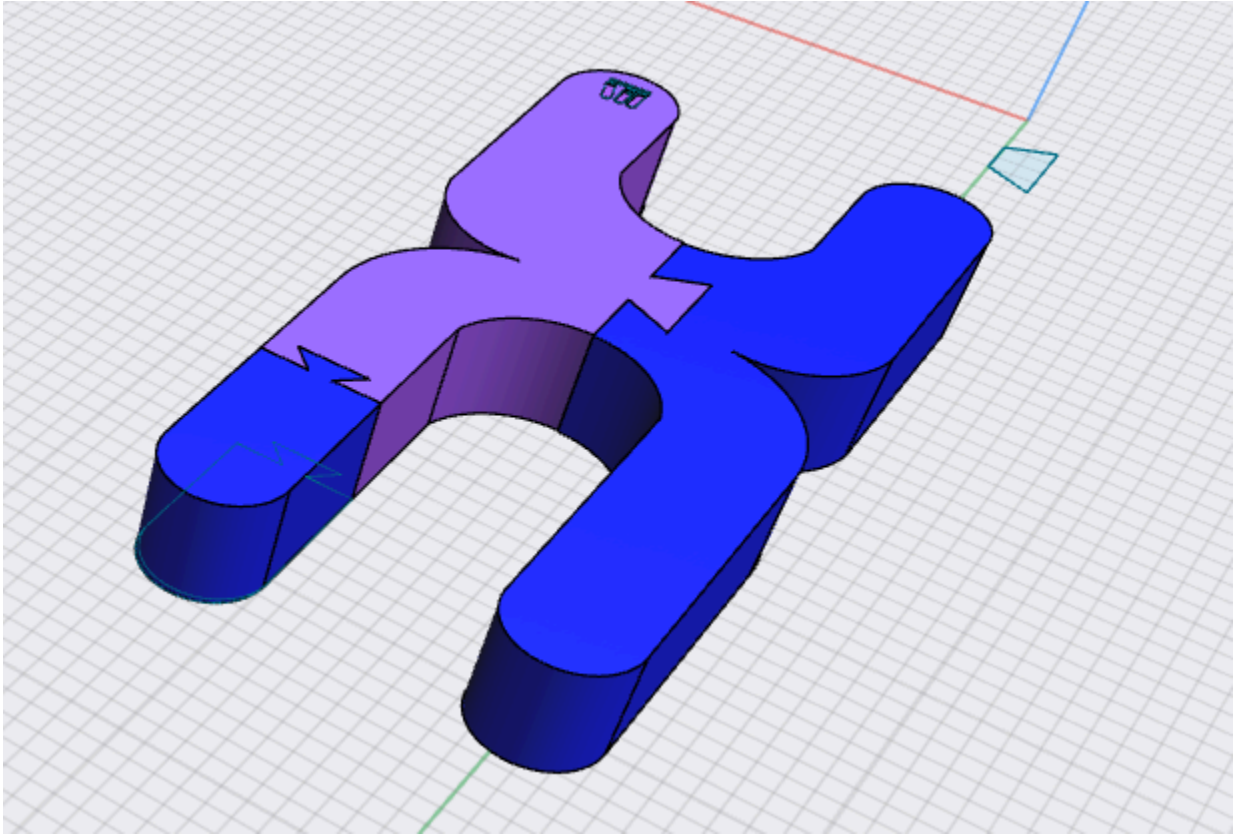

Top view of Chromosomes of Mitosis and Meiosis

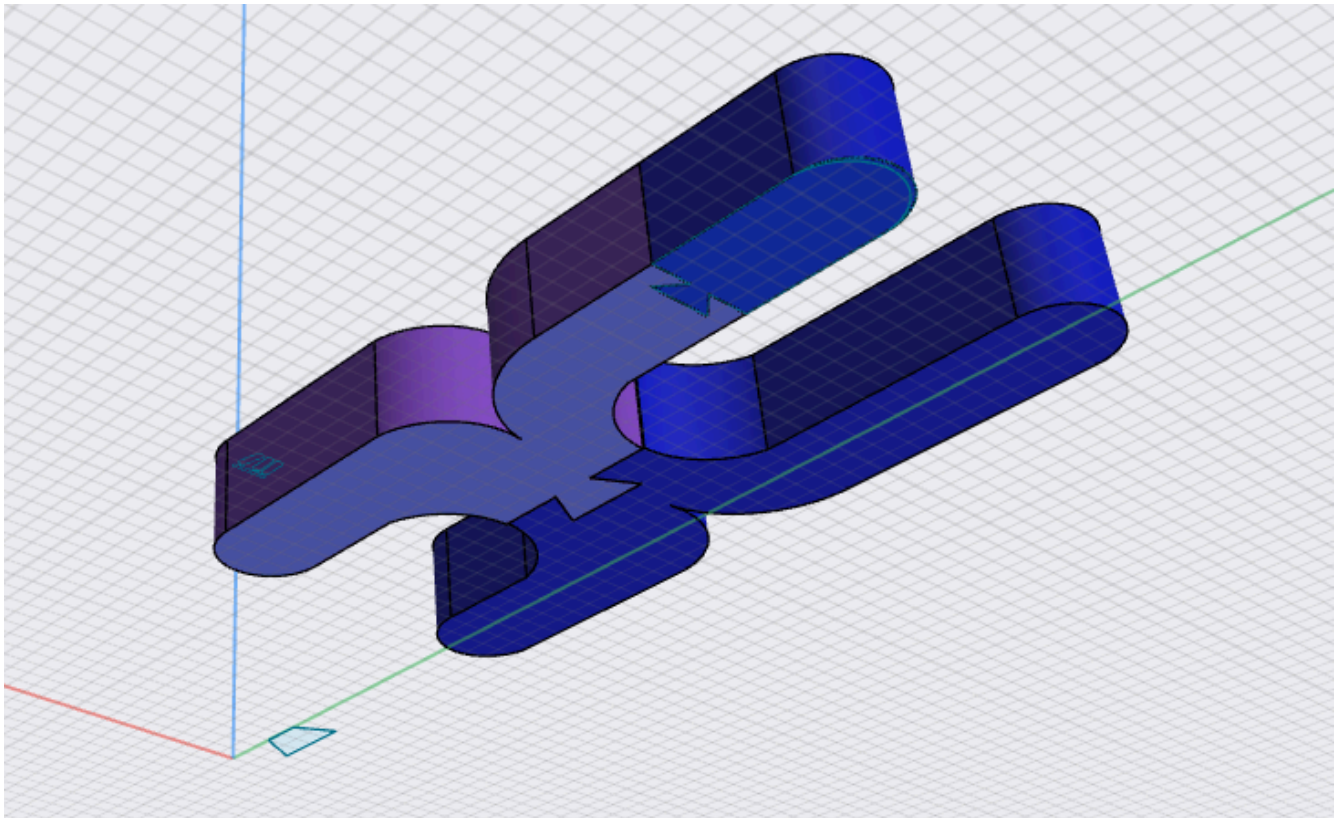

Bottom view of Chromosomes of Mitosis and Meiosis

Prototype



Top view of the 3D printed Chromosomes of Mitosis and Meiosis

Note – The parts of this model can also be printed separately and act as a “put together” or “pull apart” demonstration. Please refer to picture below.



Top view of the 3D printed put together / pull apart Chromosomes

Points to Note

- The model was printed using white PLA only. With coloured PLA, printed prototype should look similar to that in computer image.
- This model can work as a “pull apart” model with different print settings. Use different filament / PLA colours for Mitosis and Meiosis (like in the computerized pictures).
- Each colour is texturized for those who are colour blind.

RESOURCES

1. *Transcription, translation and replication*. ATDBio. (n.d.). <https://atdbio.com/nucleic-acids-book/Transcription-Translation-and-Replication>
2. Libretexts. (2022, December 24). *7.3B: DNA replication in Eukaryotes*. Biology LibreTexts. [https://bio.libretexts.org/Bookshelves/Microbiology/Microbiology_\(Boundless\)/07%3A_Microbial_Genetics/7.03%3A_DNA_Replication/7.3B%3A_DNA_Replication_in_Eukaryotes](https://bio.libretexts.org/Bookshelves/Microbiology/Microbiology_(Boundless)/07%3A_Microbial_Genetics/7.03%3A_DNA_Replication/7.3B%3A_DNA_Replication_in_Eukaryotes)
3. *Transcription, translation and replication*. ATDBio. (n.d.-a). <https://atdbio.com/nucleic-acids-book/Transcription-Translation-and-Replication>