

# Forest Measurements: an Applied Approach



# Forest Measurements: an Applied Approach

hofer



# Contents

## CHAPTER 1: SLOPE

1.1 Assessing Slope of the Land	3
1.2 Field Technique Tips for Measuring %Slope	12
1.3 Tips for Measuring %Slope on Contour Maps	16

## CHAPTER 2: TREE HEIGHT

2.1 Why Tree Height?	21
2.2 Determining Tree Height	23
2.3 Using Percent Slope to Determine Tree Height	27
2.4 Using Topographic Slope to Determine Tree Height	35
2.5 Measuring Height on Irregular Trees	37
2.6 Instruments Used for Measuring Tree Height	46
2.7 Field Technique Tips for Measuring Tree Height	48

## CHAPTER 3: TREE DIAMETER

3.1 Why Tree Diameter?	57
3.2 Determining Tree Diameter	59
3.3 Instruments for Measuring Tree Diameter	65
3.4 Field Technique Tips for Measuring Tree Diameter	71

## CHAPTER 4: TREE AGE

4.1 Determining Tree Age	77
4.2 Young trees	79
4.3 Field Technique Tips for Counting Whorls:	82
4.4 Forest Setting	85
4.5 Increment Boring	88
4.6. Field Techniques for Increment Boring	93

## CHAPTER 5: STAND CHARACTERISTICS

5.1 Stand Structure	101
5.2 Crown Classes	107
5.3 Live Crown Ratio	112
5.4 Field Technique Tips for Determining Crown Class and LCR	115
5.5 Stand Growth and Development Over Time	119
5.6 Application of LCR and Crown Class in Forest Management	129

## CHAPTER 6: SITE QUALITY

6.1 Forest Site Productivity	133
6.2 Overview of Site Index	137
6.4 Characteristics of Suitable Site Index Trees	141
6.5 Field Technique Tips for Determining Site Index	144
6.6. Determining Site Index from Field Measurements	147
6.3 How to Use Site Index Curves	150
Glossary	153





# Chapter 1: Slope



# 1.1 Assessing Slope of the Land

Here in the Pacific Northwest, we are fortunate to work in a landscape of varied landforms – from volcanic peaks to wide valleys; from steep, forested hillsides to gently rolling savannas; from rapidly cascading mountain streams to meandering river floodplains. Our varied topography is an integral part of our forest ecosystems, influencing our climate, soils, water, plant life and fish habitat (Figure 1.1). As natural resource technicians, we are often called upon to assess the topography, and one of the common elements we measure is the slope of the land. How steep is the hillside? Does the slope drain to a stream? Are there cliffs or bluffs present? Field data collected by technicians lead to informed decisions about land management activities such as providing shade for streams, building roads or trails, and prescribing timber management operations.



Figure 1.1. The Muddy Fork of the Sandy River originates from snowfields on the west flank of Mt. Hood, carrying coarse gravels and sand downstream. Fine soils from the surrounding steep, forested slopes also make their way down the slope to the river.

## DEFINING SLOPE

**Slope** of the land is essentially the gradient or incline of the land. A steep slope refers to a sharp incline; a gentle slope refers to a slight incline. The steep, forested slopes in Figure 1.1 contrast with the gentler slope of the river's path as it flows between them.

Driving down a highway you may see a road sign that reads "6% Grade" or "steep grade." The *grade* of the road is essentially the *slope* of the road. The sign in Figure 1.2 indicates that the road descends at a 6% grade or a 6% *slope*.



Figure 1.2. A road sign indicating an 8% grade, or 8% slope. ([www.dot.state.co.us](http://www.dot.state.co.us))

A 6% slope means that the road elevation changes 6 feet for every 100 feet of horizontal distance (Figure 1.3).

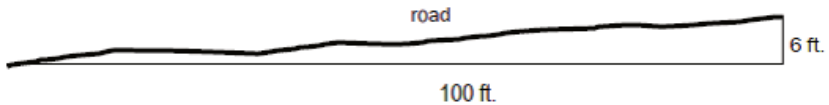

Figure 1.3. A road climbs at a gradient of 6%. The road gains 6 feet in elevation for every 100 feet of horizontal distance. Note that the length of the road itself is longer than 100 feet.

Mathematically, **slope** is defined as “the rise over the run” (or the rise divided by the run), where rise equals change in elevation and run equals horizontal distance:

$$\text{slope} = \frac{\text{rise}}{\text{run}} \text{ or } \frac{\text{elevation change}}{\text{horizontal distance}} \text{ or in this case: } \frac{6\text{ft.}}{100\text{ft.}} = .06$$

To express slope as a **percent slope**, we simply multiply the slope fraction by 100. So,  $.06 = 6\%$

$$\left(\frac{\text{rise}}{\text{run}}\right)(100) = \% \text{slope}$$

$$\left(\frac{6}{100}\right)(100) = 6\%$$

In our road example, the six foot change in elevation is the **rise** and the 100 foot *horizontal distance* of the road is the **run**. Driving uphill, we climb a  $+6\%$  slope (Figure A below). Driving downhill, the “rise” is actually a “drop,” so we have a negative slope, or a downhill slope (Figure B below). When dealing with slope, a positive slope simply means uphill and a negative slope means downhill. A negative number does not mean “minus” as in algebraic expressions.

Figure A

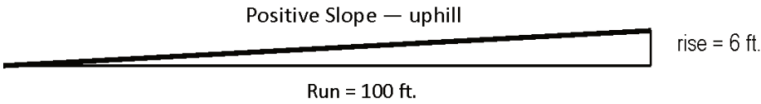
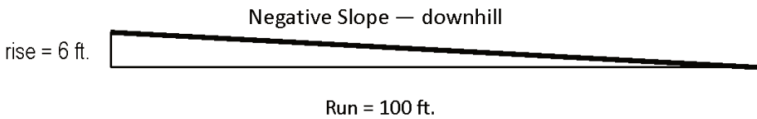

Figure B



Note that the actual road distance is the *hypotenuse* of the illustrated slope triangle. Its length is called **slope distance**. Slope distance is *always* longer than the horizontal distance, or run. Applying the

Pythagorean Theorem ( $a^2 + b^2 = c^2$ ) to this triangle, we can calculate the slope distance, or hypotenuse (c).

$$a^2 + b^2 = c^2 \quad \text{where: } 100^2 + 6^2 = c^2 \quad 10,036 = c^2 \quad \sqrt{10,036} = 100.2 \text{ ft.}$$

a = horizontal distance or run (in this example 100 ft.)

b= change in elevation or rise (in this example 6 ft.)

c = road distance or slope distance (in this example 100.2 ft.)

We calculated a slope distance of 100.2 ft. for a run of 100 ft. As you can see from this example, in a forest, a 6% slope would be considered a gentle slope.

Note that %slope is unitless and proportional. Therefore, it can be applied to any unit of measure (inches, yards, centimeters, etc.) and to any length. For example, a 25% slope is simply a 25:100 ratio. The 25% slope below shows that for every inch of horizontal distance, the slope rises .25 inches. For every 10 centimeters of horizontal distance, the slope rises 2.5 cm, and for every 5 inches of horizontal distance, it rises 1.25 inches.

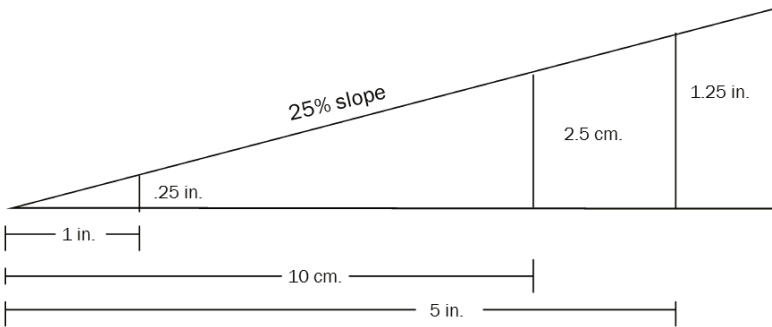

### USING SLOPE

When writing field notes about a site, we include information about the slope of the land. Sometimes a rough estimate of the average slope

is sufficient; sometimes detailed measurements of slope are required. For example, a site description might read:

“A timber cruise was conducted on 20 acres of mixed conifer forest .....Approximately half of the acreage was flat, on slopes ranging from 3-7%. The other half of the acreage was steeper; with southwest slopes 40-60%.”

This tells us much more about the site than simply stating that there were 20 acres of mixed forest. We would expect different soil conditions and different vegetation to be present on the different slopes, and therefore, perhaps different management. Let's say, for example, that these 20 acres are to be logged in the near future. If this is so, the forester will have to plan where to place any new access roads, where to locate landings for yarding the logs and what type of harvesting equipment to use. He knows that the slope of any new spur roads should not exceed 10%, and a cable system should be used to haul logs up to landings on slopes greater than 30% (Figure 1.4).

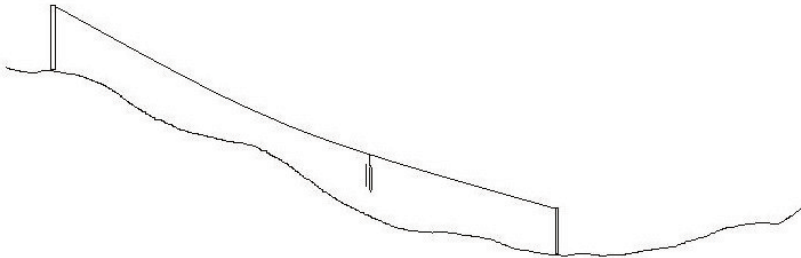

Figure 1.4. A cable logging system can be used on steep slopes to suspend logs above the ground as they “yard” the logs up the slope to a landing.

**Profiles** may be run to get a detailed picture of the slope. When profiling a hillside, slope distances and %slope readings are taken where each major change in slope occurs (Figure 1.5). With this



precise information, a logging system can be designed that will lift logs off the ground while yarding to reduce erosion.

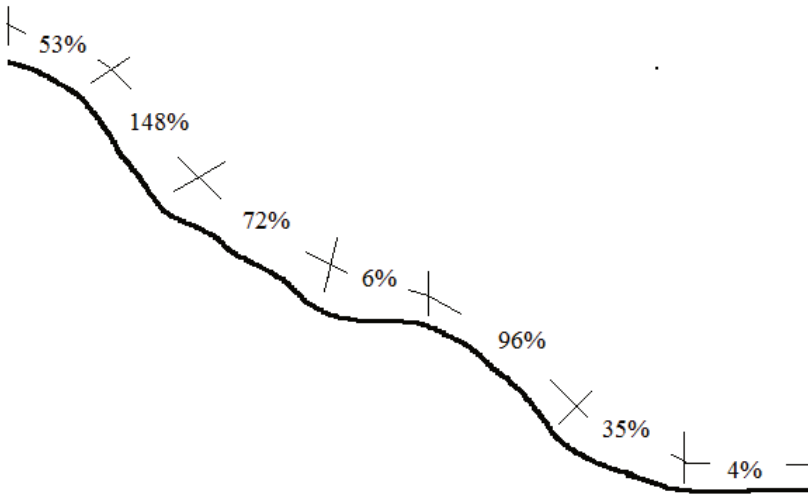
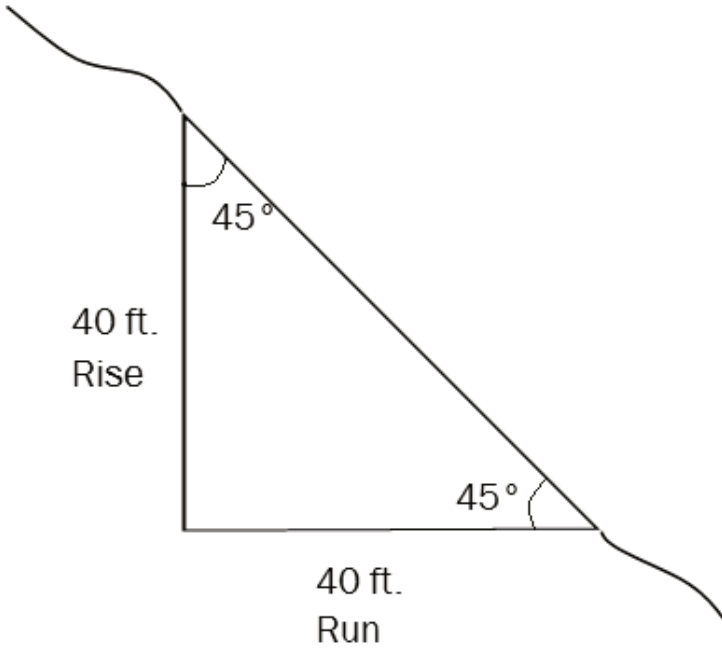

Figure 1.5. A hillside is divided into segments where major changes in slope occur. For each segment, a %slope reading is taken. These %readings are combined with measurements of the slope distance for each segment to create a profile or sketch of the hill like the one illustrated.

Note that slopes can exceed 100%. When a slope equals 100%, it simply means that the rise is *equal to the run*. And although it certainly *feels* like you are climbing straight up on a 100% slope (pulling yourself up using roots and anything else you can grab), you are really walking up at a 45° angle, not a 90° angle.

$$\left(\frac{\text{rise}}{\text{run}}\right) (100) = \% \text{slope}$$



If rise = run as illustrated above:  $\left(\frac{40}{40}\right)(100) = 100\%$

100% slope = 45° angle slope

Other examples of where %slope is measured in natural resource settings include hiking trails and streams. Switchbacks on steep slopes reduce trail erosion and make hiking easier. Some trails are kept to 8% to comply with American with Disabilities Act (ADA) guidelines for wheelchair access.

Stream gradients vary, reflecting the terrain over which they flow at each stage of their journey to large rivers. Small tributaries often are the steepest, cascading down steep forested slopes at gradients of 60-100% slope or more. As streams merge downriver, the terrain often flattens out, and milder gradients of 3-10% slope may be measured (Figure 1.6).



Figure 1.6. Streams rush down steep slopes at their headwaters. As they reach valley bottoms and merge with other streams, their gradients are reduced and a more meandering route may result.

## 1.2 Field Technique Tips for Measuring %Slope

Slope is generally measured with an instrument called a **clinometer**. When sighting through a clinometer, the measuring line is placed on the target, and %slope is read from the scale. Both eyes are open, as one eye reads the scale, and the other eye sights on the target (Figure 1.7).

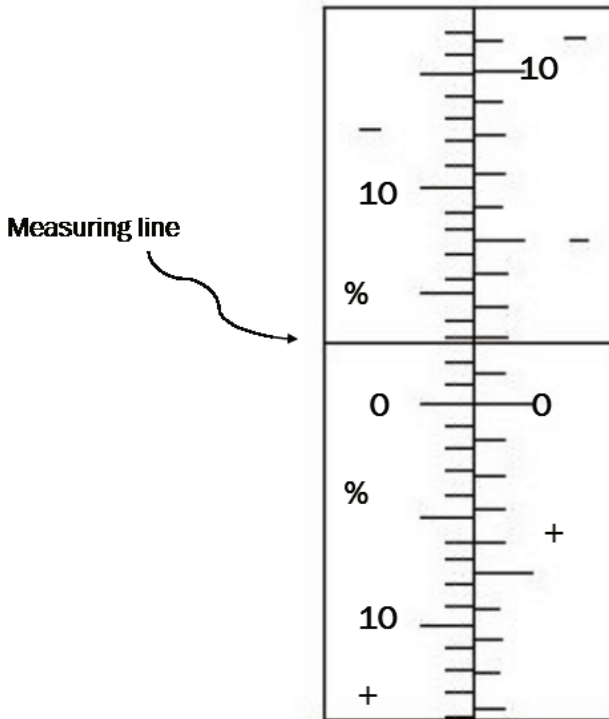

Figure 1.7. A clinometer generally has two scales. In this figure, the scale on the left is the %slope scale. The scale on the right is a topographic slope scale (see Chapter 2). Also note the “plus” signs below zero on each scale, and the “minus” signs above zero on each scale. In this illustration, the %slope reading is just under 3%. Since the reading is on the “minus” side of zero, the person using the clinometer is looking slightly downhill.

1. Measuring %slope for profiles is easiest to do with a partner. First determine where 0% slope (eye level) is on your partner. Then use this point as the target when taking readings with the clinometer (Figure 1.8). This way, you will be measuring parallel to the slope, mirroring the land.

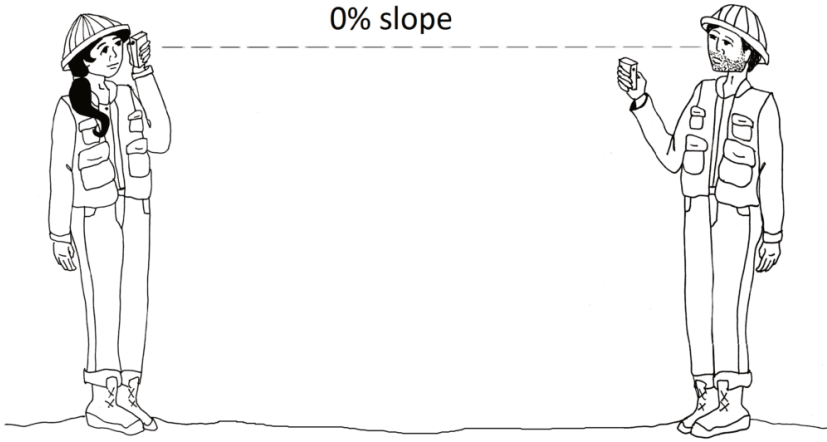

Figure 1.8. Standing on level ground close to each other, partners first determine where 0% slope is on the other person. In this example, the technician on the left will sight on her partner's nose when taking %slope readings with the clinometer.

2. To determine %slope, one partner walks up or down the slope to a point where a reading should be taken, such as a major change in slope. A reading is taken and recorded to the nearest % (Figure 1.9).

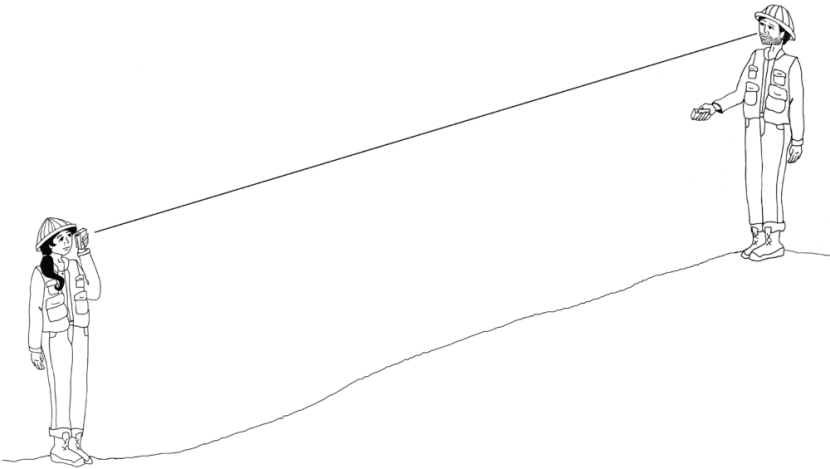

Figure 1.9. Sighting on a partner at eye level (as determined beforehand in Figure 1.8) allows a person to obtain an average %slope reading, paralleling the slope of the land.

3. When working where there is a lot of brush, it may be difficult to see your partner. A brightly colored target held at the sighting point, such as a painted piece of cardboard, can substitute for your partner. Your partner's hard hat will work in a pinch as well.
4. When working individually on forested slopes, you will have to substitute a tree for your partner. Estimate eye level on a tree that you can see clearly, and take a reading on that point. When determining average slope on a long hillside, try to pick a point as far down or up the hill as possible, to even out the slight dips and bumps on the ground.

## 1.3 Tips for Measuring %Slope on Contour Maps

To calculate %slope of the land from contour maps, we still need to determine the rise and run. On a map, the **rise** is the difference in elevation between two points. The **run** is the horizontal distance between two points. Map distance is *always* horizontal distance.

The Rise is the difference in elevation between two points. Using the elevations printed on the map and the contour line interval, an elevation can be determined for the top and bottom of the slope in question. It generally works better to simply determine the elevation at each point and subtract rather than to “count the contour lines” between the two points. Doing the latter often results in rounding errors or double counting a contour line that can throw slope readings off by 10% or more.

To determine the run, the map distance is measured between the two points, and converted to the *same units* as the elevation. If difference in elevation is measured in feet, distance should also be calculated in feet. If difference in elevation is measured in meters, distance should also be calculated in meters.

Example:



An excerpt from a contour map is shown below. To determine the %slope from Point A to Point B, we must first determine the **rise** and **run**.

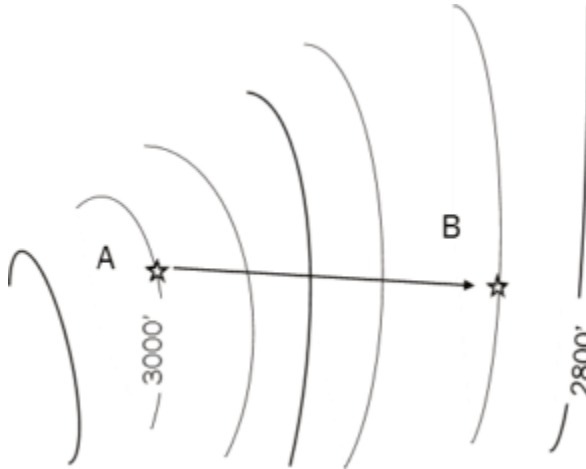

**Rise:**

If the map has 40' contour intervals, then Point A is located at 3000 feet. Point B is located at 2840 feet. Therefore:

Rise = change in elevation = top (Point A elevation) minus bottom (Point B elevation):  $3000' - 2840' = 160$  feet

**Run:**

If the map scale is 1 inch = 500 feet, then the run is calculated as follows:

The map distanced measured 1.8 inches with an engineer's scale.

$$(1.8 \text{ in.}) \left(\frac{500 \text{ ft}}{1 \text{ in.}}\right) = 900 \text{ feet}$$

**%slope:**

$$\left(\frac{\text{rise}}{\text{run}}\right) (100) = \% \text{slope}$$

$$\left(\frac{160}{900}\right) (100) \approx 18\%$$

hofer

From Point A to Point B, the slope is  $-18\%$  (downhill); from B to A the slope is  $+18\%$  (uphill).

## Chapter 2: Tree Height



## 2.1 Why Tree Height?

Forests of the Pacific Northwest can produce very tall trees. Fertile soils, a mild climate, and a long growing season west of the Cascade Mts. yield old-growth Douglas-fir (*Pseudotsuga menziesii*) forests that rise 250 feet in the air (Franklin 1988). East of the Cascades, ponderosa pine (*Pinus ponderosa*), reaching over 150, feet is no less impressive (Burns and Honkala 1990). Tree height is an important ecological trait, as the competition for sunlight determines which trees flourish, and which trees become suppressed and eventually die out. It also influences shade in streams, changes in understory vegetation over time and cover for wildlife. As such, it is an important part of many natural resource data collections.

Here are some examples of where height measurements are used:

- Stand exams. Stand exams are conducted to characterize the forest vegetation. They provide basic, baseline data on the species composition, forest structure, and condition for a variety of stand management uses, ranging from wildlife habitat to timber production.
- Riparian/stream surveys. Height of the vegetation and physical landforms (such as bluffs) along streams can be used to predict the

amount of shade a stream will receive throughout the day and year. This in turn, can determine the width of streamside vegetation buffers reserved during any logging activity.

- Nesting sites. Some birds and cavity nesters prefer to nest and/or feed at particular heights in the forest canopy. Assessing tree and snag heights can help determine nesting suitability of forest stands.
- Site quality. Tree height is the most widely used indicator of a site's ability to grow trees.

Timber cruises. Forest inventories that determine the volume and value of wood require a height measurement – the most important factor for estimating wood volume.

## 2.2 Determining Tree Height

Most forest applications use one of two types of tree height measurements:

1. **Total height.** Total height is the height of the tree from its stump to its tiptop (Figure 2.1). A one-foot stump is standard, although there are times when another base is used.

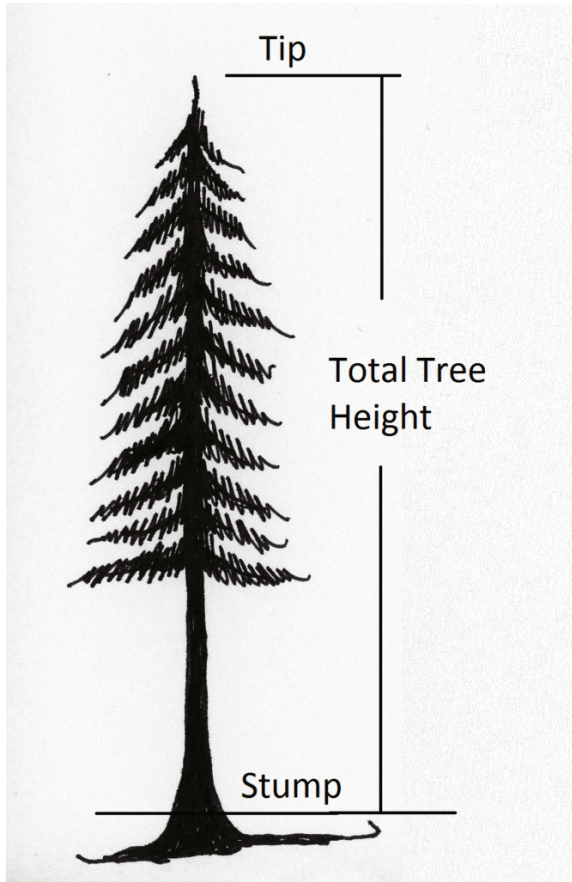

Figure 2.1. Total tree height, measured from a one-foot stump.

- 2. Merchantable height.** Merchantable height is the height of the tree from its stump to a diameter at which the trunk is too small to be marketable (Figure 2.2). This “merchantable top” diameter is commonly 6” or some percentage of a diameter low in the tree, such as dbh (see Chapter 3). “Taper height” is very similar, without the emphasis on the top diameter being the end of merchantability.



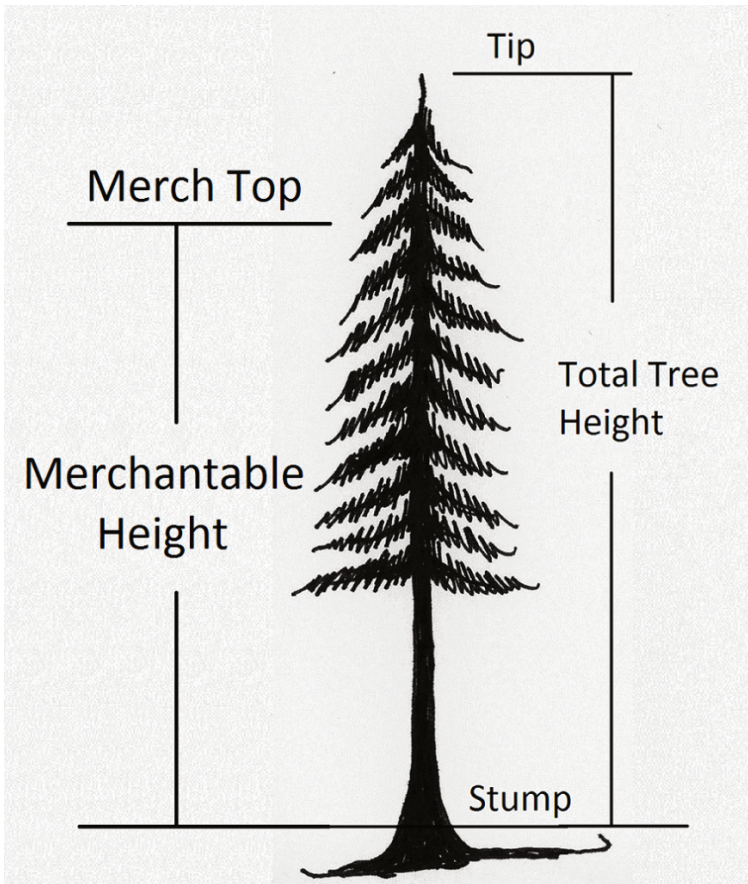

Figure 2.2. Merchantable height is the height from the stump to a trunk diameter where the tree can no longer be cut into logs for sale.

The principles and techniques for measuring any of these heights are essentially the same. We will focus on total height in this text.

So how in the world do we figure out how tall a tree is? Surely we don't climb each tree with a tape or cut every tree down to measure it. We need a simple, straightforward, and quick way to measure tree height to make it a feasible part of our inventory data. Here is the easiest way for good precision:

In determining tree height, we presume that the tree is

perpendicular to the ground. Therefore, the tree makes a right angle with the ground, and a right triangle can be drawn from it. The triangle's three sides are: 1) the tree, 2) the horizontal distance along the ground, and 3) an imaginary diagonal line running from the top of the tree to the ground. Likewise, the tree's height can be considered the *rise* and the horizontal ground distance the *run*. (Sound familiar?) If we can measure a horizontal distance from the tree to a place where we can see the tree's top, we can determine the tree's height using %slope (Figure 2.3).

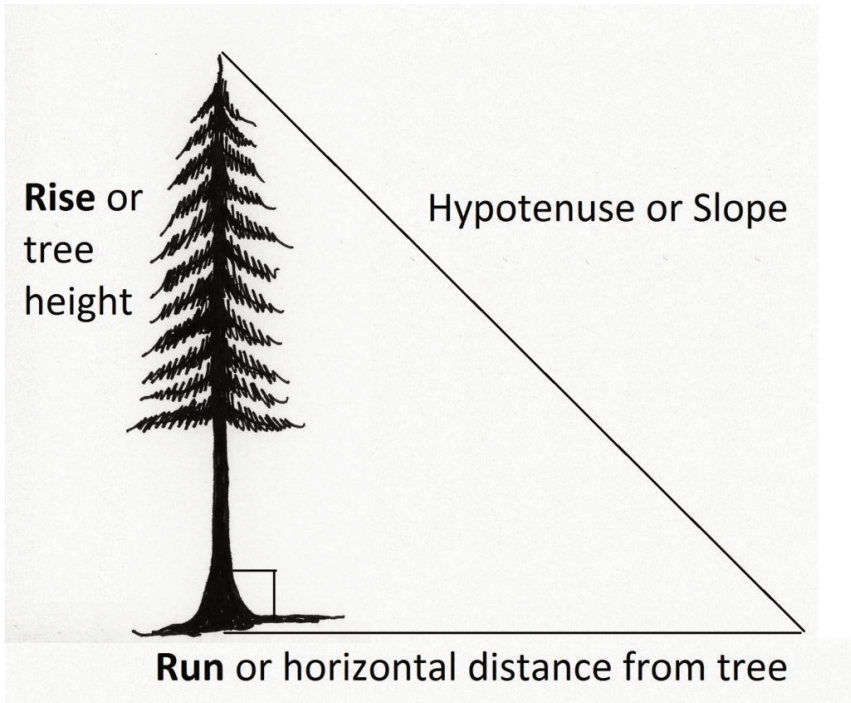

Figure 2.3. A tree makes a right angle with the ground, so a triangle or slope can be drawn using it and the ground.

## 2.3 Using Percent Slope to Determine Tree Height

When using percent slope to determine tree height, the tree is the rise, and the horizontal distance from the tree along the ground is the run (Figure 2.3). We can easily measure our horizontal distance from the tree, and we have instruments for measuring the percent slope to the top of a tree. So, with those two measures (run and %slope) we can solve for rise.

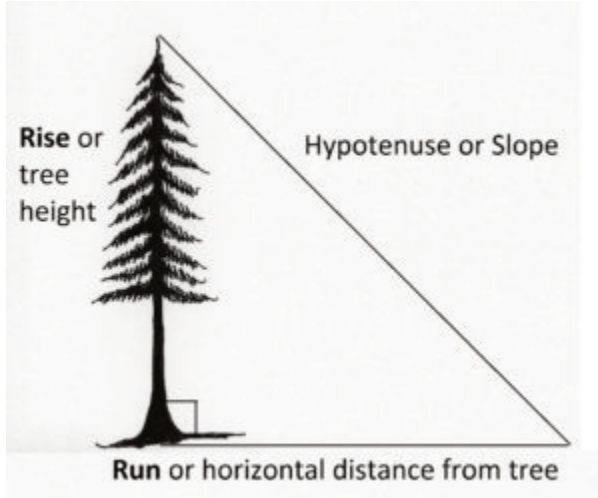

Figure 2.3. A tree makes a right angle with the ground, so a triangle or slope can be drawn using it and the ground.

$$\left(\frac{\text{rise}}{\text{run}}\right)(100) = \% \text{slope}$$

To solve the %slope equation for “rise” we do the following:

1. Multiply both sides of the equation by “run” to cancel out run on the left side of the equation

$$\frac{(\text{run})(\text{rise})(100)}{\text{run}} = (\text{run})(\% \text{slope})$$

2. Divide both sides by “100” to cancel out 100 on the left side of the equation

$$\frac{(\text{rise})(100)}{100} = \frac{(\text{run})}{100}(\% \text{slope})$$

That leaves us with the following equation:

$$\text{rise} = \frac{(\text{run})}{100}(\% \text{slope}) \text{ where rise = height}$$

Notice that the %slope multiplier (100) becomes the denominator. This remains a constant. The run and %slope values are measurements, so they will change with each tree.

Here are some examples using %slope for tree height:

**Example 1:**

Georgia walks out a horizontal distance of 50 feet from a tree (Figure 2.4). She looks through her **clinometer** to determine the %slope from her eye to the top of the tree. Looking up, she reads “+124%.” Using our formula to determine the “rise:”

$$\text{rise} = \frac{(\text{run})}{100}(\% \text{slope})$$

$$\text{rise} = \frac{(50)}{100}(+124) = +62 \text{ or } 62 \text{ feet}$$

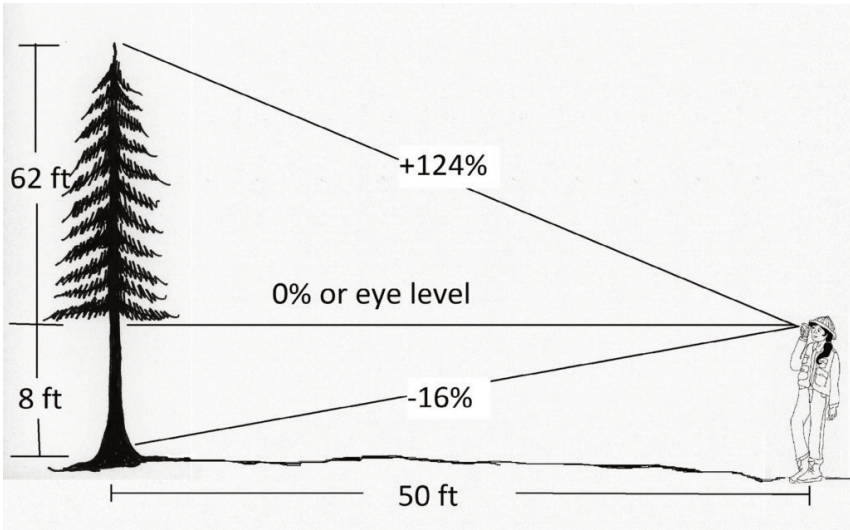

Figure 2.4. Using a clinometer and %slope to determine total tree height.

Therefore, the height of the tree from her eye to the top is 62 feet. Next, we use the same procedure to determine the height from Georgia’s eye level down to the stump. Georgia takes a reading *down* to the stump. She reads -16%.

$$\text{rise} = \frac{(\text{run})}{100}(\% \text{slope})$$

$$\text{rise} = \frac{(50)}{100}(-16) = -8 \text{ or } 8 \text{ feet}$$

Georgia measured 62 feet from her eye to the top of the tree, and 8

feet from her eye to the stump of the tree. We *add* those two measures together to get the total height of the tree.

$$62 \text{ ft (top)} + 8 \text{ ft (base)} = 70 \text{ ft.}$$

Remember that a negative slope measurement simply means you are looking downhill. It is important to recognize that the -8 feet is a drop in elevation, *not a negative value*.

We can do the two calculations in one step as follows:

$$\text{rise} = \frac{(\text{run})}{100} (\% \text{slope})$$

$$\text{rise} = \frac{(90)}{100} (124+16) = 70 \text{ or } 70 \text{ feet}$$

Notice Georgia put “+16” in the formula, even though the reading to the stump was a negative number. She wants to *add in* the bottom height, not subtract it. Again, a negative slope simply means we looked downhill. You have to think about your eye position in relation to the tree, and what the readings actually mean. Using %slope symbols algebraically can be misleading.

### Example 2:

Tobias walks out a horizontal distance of 100 feet from the same tree (Figure 2.5). He looks to the top of the tree and reads “+62%” on his clinometer. He looks down to the stump and reads “-8.”

$$\text{rise} = \frac{(\text{run})}{100} (\% \text{slope})$$

$$\text{rise} = \frac{(100)}{100} (62+8) = 70 \text{ or } 70 \text{ feet}$$

Notice that by walking farther from the tree (having a longer run), Tobias’ slope readings were smaller than Georgia’s, even though they both ended up with the same height. The angles at which Tobias was looking at the tree were smaller (less acute).

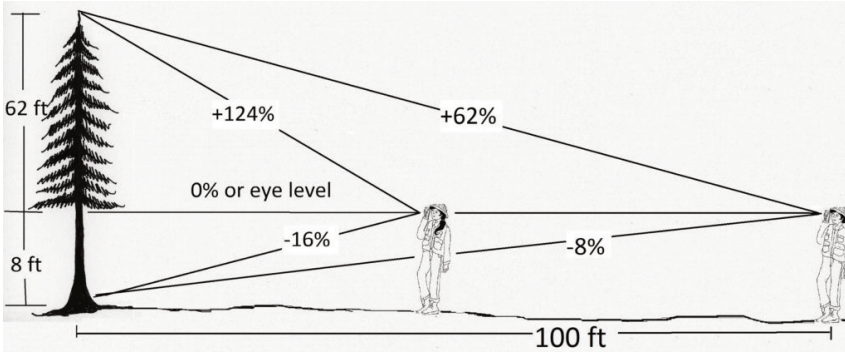

Figure 2.5. A tree can be measured from any distance, but the farther back one is from the tree, the less foreshortened the view, and generally, the more accurate the slope readings.

Also notice that when Tobias walked out 100 feet from the tree, his *run* equaled the denominator, 100, cancelling it out and leaving the tree equal to the readings from the clinometers. This “shortcut” makes it much easier and faster to determine tree height by reducing the number of conversions that have to be made.

$$\text{rise} = \frac{(100)}{100}(62+8) = 70 \text{ or } \mathbf{70 \text{ feet}}$$

What happens at a horizontal distance of 150 feet? The slope readings are even smaller.

$$\text{rise} = \frac{(\text{run})}{100}(\% \text{ slope})$$

$$\text{rise} = \frac{(150)}{100}(42+5) = 70 \text{ or } \mathbf{70 \text{ feet}}$$

Thus, the farther one walks from the tree, the better the perspective for seeing the tree top. Being too close to the tree can result in an obscured top, as side branches will be in the way (Figure 2.6).

hofera







In the photo on the left, the tree's top can clearly be seen. The right photo however, illustrates a foreshortened view of the top where side branches could be mistaken for the top.

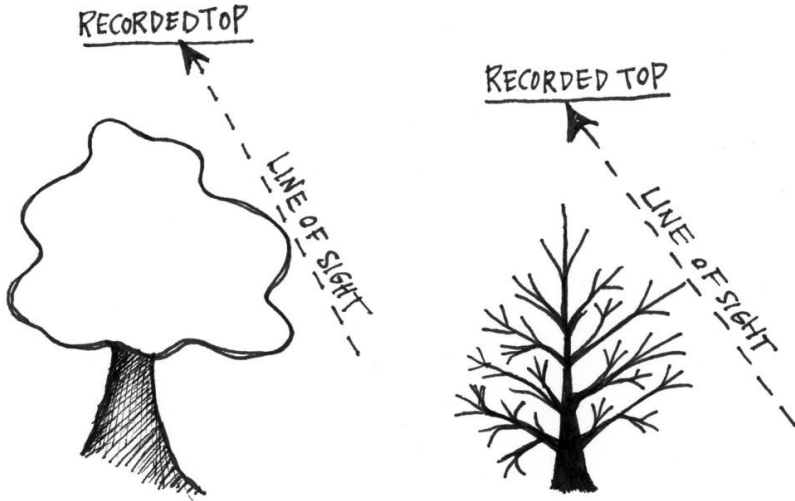

Figure 2.6. Examples of height measurement error from sighting on a side branch thought to be the top, on both a hardwood and a conifer. Height is overestimated.

## 2.4 Using Topographic Slope to Determine Tree Height

For most natural resources management purposes, land areas and distances are measured in English units. (Research data are collected in metric units.) Therefore, we measure area in acres, tree height in feet, and commonly, horizontal distance in chains (1 chain = 66 ft.). For this reason, many instruments for measuring slope have two scales: %slope and topographic slope. Topographic slope (or Tslope) is essentially the same as %slope, except that instead of expressing the ratio of rise over run as a proportion of 1:100, Tslope is expressed in a proportion of 1:66 as follows:

$$\left(\frac{\text{rise}}{\text{run}}\right)(66) = \text{Tslope}$$

The different multiplier (66) is the only difference between Tslope and %slope. To solve the Tslope equation for “rise” we do the following:

1. Multiply both sides of the equation by “run” to cancel out run on the left side of the equation

$$\frac{(\text{run})(\text{rise})(66)}{\text{run}} = (\text{run})(\text{Tslope})$$

2. Divide both sides by “66” to cancel out 66 on the left side of the equation

$$\frac{(\text{rise})(66)}{66} = \frac{(\text{run})}{66}(\text{Tslope})$$

That leaves us with the following equation:

$$\text{rise} = \frac{(\text{run})}{66}(\text{Tslope}) \quad \text{where rise} = \text{height}$$

So, just as with %slope, the Tslope multiplier (66) becomes the denominator.

Topographic slope is most commonly used when measuring merchantable height, but is also fine for measuring total height on shorter trees. Here is an example (Figure 2.7):

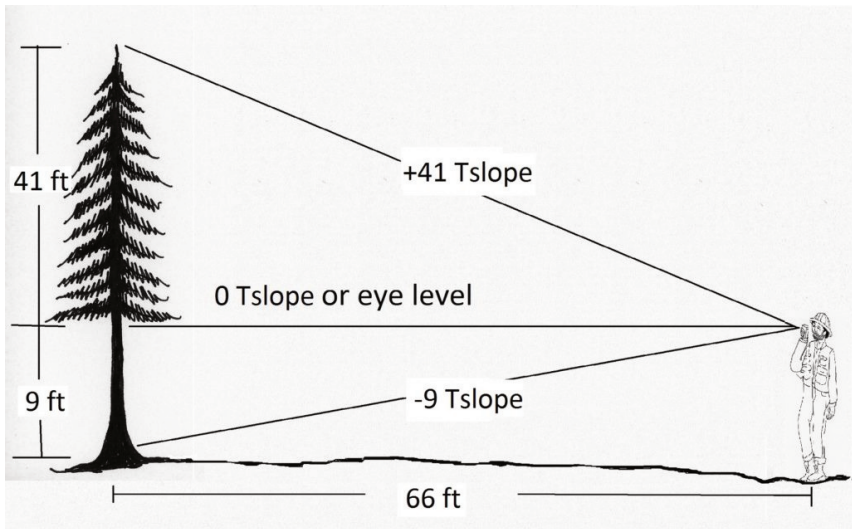

Figure 2.7. If Jake walks out a horizontal distance of 66 feet (one chain) from the tree, his run will equal the Tslope multiplier. The “66” will cancel out, and he can simply add his top and stump slope readings together.

$$\text{rise} = \frac{(\text{run})}{66}(\text{Tslope})$$

$$\text{rise} = \frac{(66)}{66}(41+9)$$

$$\text{rise (height)} = 50 \text{ feet.}$$

## 2.5 Measuring Height on Irregular Trees

**Species considerations:** It is quite easy to measure tree height on conifers because conifers have a very distinct top. Each year's whorl of growth produces a clear tip with short lateral branches, even on hemlocks (*Tsuga* spp.)(Figure 2.8).



Figure 2.8. Conifers have clear, distinctive tops that make finding the top easy.



Figure 2.9. Hardwoods such as this oak (*Quercus kelloggii*) have rounded or uneven crowns that can make finding the top a little more difficult.

Hardwoods on the other hand, have rounded crowns that are often a function of the amount of sun they are able to capture (Figure 2.9). Under shaded conditions, they may be very one-sided. On hardwoods, it is extremely important to get a clear view of the whole crown, so that side branches are not mistaken as the top.

**Broken tops:** Trees in which the top has blown out can be tricky. The short or nonexistent tip is often hidden by long lateral branches near the top of the tree. If the top cannot be seen clearly, it is easy to mistake the tips of the lateral branches for the top. A rounded or flat top in a conifer suggests a missing top, and this type of tree should

always be examined closely (Figure 2.10). As we saw in Figure 2.6, measuring a lateral branch instead of the tip can overestimate the tree's height. The closer one is to the tree, the greater the error. This is another reason why it is important to walk a distance far enough from the tree to get a clear view of the top.



Figure 2.10. A flat-topped fir tree. When conifers have such “eagle nest” tops, it indicates that the main stem has broken out of the tree. Note how large the diameter is at this point.

When measuring total height on trees with broken tops, the tree top must be “reconstructed,” in order to maintain the tree's correct



taper, or “original” shape. Incorrect taper will affect wood volume estimates. A normal tree that is 124’ tall (A below) has a very different shape than a tree whose top has broken out at 124’ (B below). The standard method for reconstructing a tree’s top is to look at the surrounding trees and estimate the broken tree’s missing height from their growth. Let’s say a tree similar in diameter and taper to the broken-top tree below (C below), runs 20 feet from a diameter of five inches to its tip (Figure 2.11). Using this as a guide, one could add 20 feet to the broken-top tree for a reconstructed total height of 144 feet.

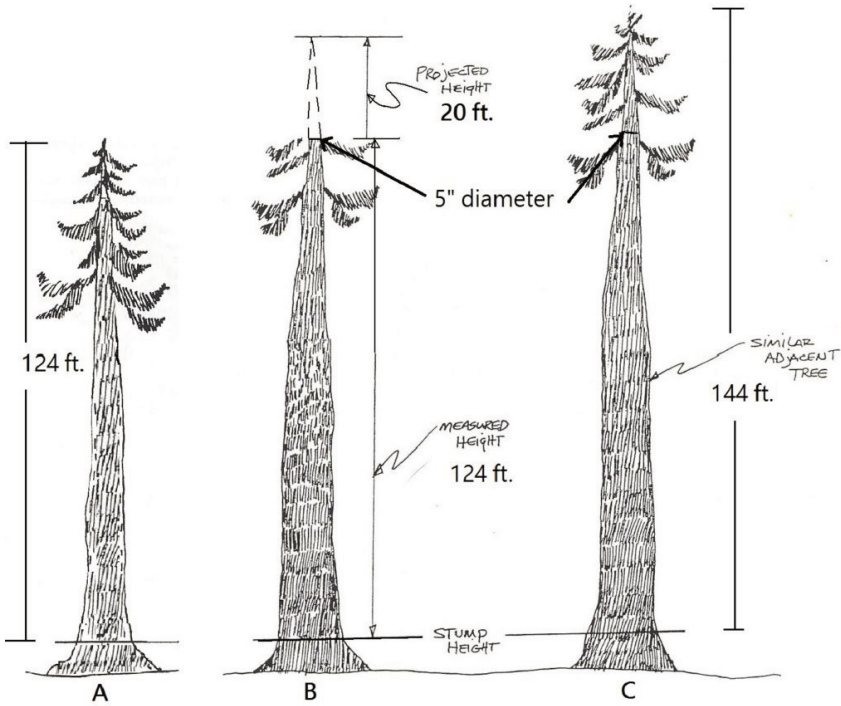

Figure 2.11. To estimate how much height to add on to a broken-top tree, a neighboring tree that is similar in size and taper is measured and used as a guide. In this example, the top broke out at a diameter of 5 inches. A similar tree was measured from a diameter of 5 inches to its top. This length was 20 feet. Therefore, 20 feet was added to “reconstruct” the top of the broken tree for a total height of 144 feet. (Adapted from [FS] 1990.)

**Leaning trees:** For a leaning tree, we have to adjust our image of the tree-to-ground triangle. In this case, the leaning *tree* is the *hypotenuse* of the triangle instead of the rise (Figure 2.12). The height of the tree can be estimated using the Pythagorean Theorem and the following steps:

1. Measure out a horizontal distance from the *tip* of the tree until it is clearly in view.

2. Calculate the perpendicular distance from the tip of the tree to the ground (rise), using %slope readings as before.
3. Measure the horizontal distance from the perpendicular drop to the base of the tree (the run).
4. Once these two sides of the triangle have been determined, estimate the total tree height using the Pythagorean Theorem to solve for the hypotenuse.

See the example in Figure 2.12 below:

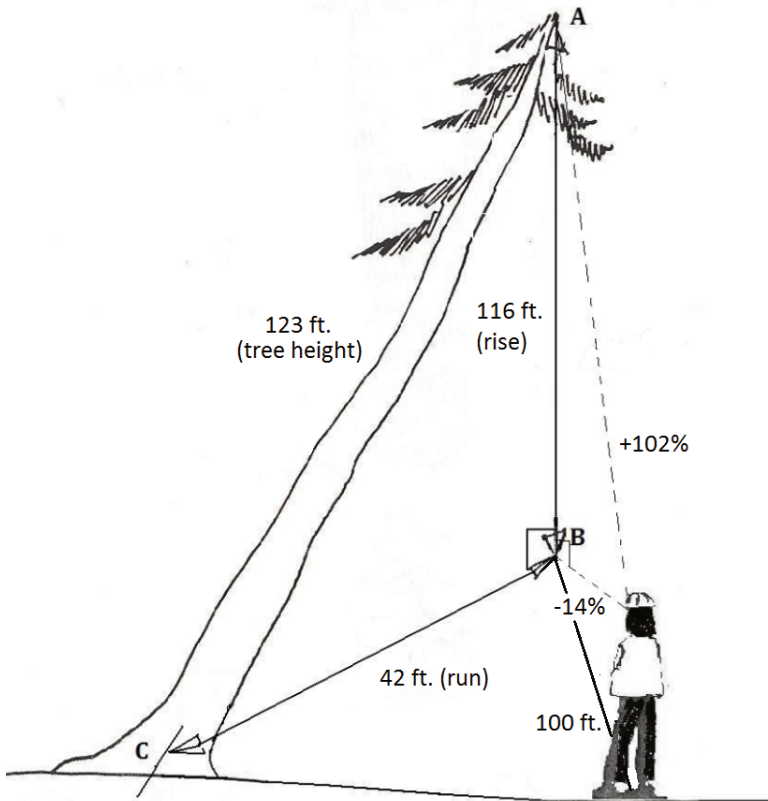

Figure 2.12. Total height of a leaner tree is determined. (Drawing adapted from [FS] 1990.)

1. The technician walks out a horizontal distance from fall line AB (in this case 100 ft.).
2. A %slope reading is taken to the tip of the tree (A, +102%), and then to the point on the ground where the AB fall line intersects the ground (B, (-14%). Using the two %slope readings, the rise of the triangle is determined; in this case, 116 feet.
3. The horizontal distance between Point B and the stump of the tree (C) is measured with a tape to determine the run; in this case 42 feet.
4. Finally, using the Pythagorean Theorem, the hypotenuse or height of the tree can be determined.

$$c^2 = a^2 + b^2$$

or

$$c = \sqrt{a^2 + b^2}$$

so

$$c = \sqrt{116^2 + 42^2}$$

and

$$c = \sqrt{15220}$$

$$c = 123 \text{ feet.}$$

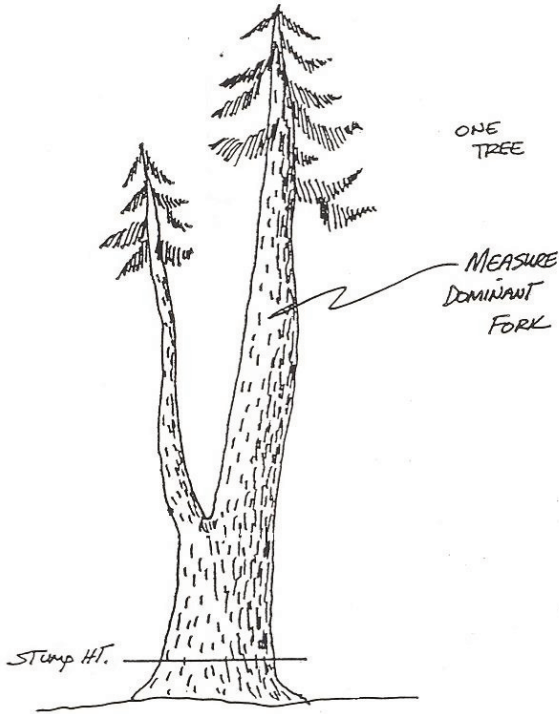

Figure 2.13. On forked trees, total height is measured from the tree stump to the tip of the tallest fork. (From [FS] 1990.)

**Forked Trees:** On forked trees, the tallest, or dominant fork is measured (Figure 2.13). In some cases, the second fork occurs low enough in the tree to be counted as a second tree, but for most trees, the tallest fork is the only merchantable fork.

## 2.6 Instruments Used for Measuring Tree Height

A number of different instruments can be used to determine height. With the exception of the Biltmore stick, all work on the same principle of taking two slope readings. The scales in each instrument are just housed in a different setting.

- Clinometer – as shown in Chapter 1
- Relaskop—see section 3.3
- Laser range finder/electronic hypsometer (these do the math for you!)
- Biltmore stick hypsometer

Though not commonly used, a Biltmore stick is an inexpensive tool for obtaining a rough estimate of tree height. It is based on the principle of similar triangles (Figure 2.14).

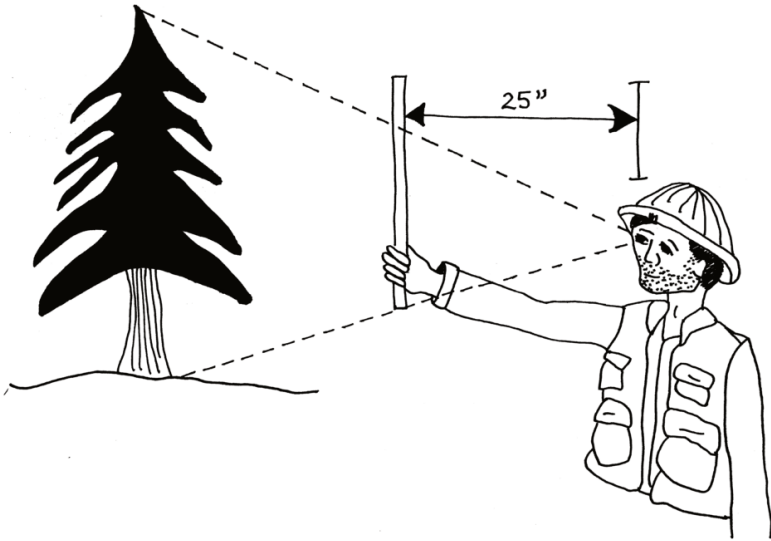

Figure 2.14. A Biltmore stick is held 25" from the eye to measure tree height. Closing one eye, the bottom of the stick is placed at stump level. Without moving one's head, tree height is read off the stick where the tree top crosses the stick. In most cases, purchased Biltmore sticks are marked with "logs" instead of feet, but it is easy to construct a stick with a variety of units.

## 2.7 Field Technique Tips for Measuring Tree Height

Estimating total tree height is very easy to do correctly, but does require that we think about how we are taking our measurements. Here are some tips.

1. Always walk to where one can *clearly* see the tree top. This can be tough to do, especially in dense stands, on extremely foggy days, or in stands with heavy brush. Dragging a tape around in brush trying to get to that special spot where the tree tip comes into view can be frustrating, but it needs to be done. It is actually pretty rare to have a tree whose crown is impossible to see *somewhere* within 150 feet. This is why it is important to remain flexible in selecting horizontal distances. Commonly, errors in *measuring* tree heights come from measuring a branch instead of the tip, measuring the wrong tree top, or guessing where the tree top is in a dense canopy.
2. Do not always rely on that magical distance of 100 feet (Figure 2.15). Once you get comfortable with the instruments in the field, find a method that allows you to be flexible in choosing your horizontal distance from the tree. Discover a fast way to adjust your heights with varying horizontal distances. Some people *have*



to follow a formula. I don't want to mess with the formula, so I just think of 100 (for %slope) and 66 (for topographic slope) as "calibration" figures. For example:

- At 33 feet, I am 1/2 of one chain (66 feet) from the tree, so tree height is half of my topog slope readings.
- Likewise, at 50 feet, I am 50% of the way to 100; so the tree height is 50% of my slope readings. At 90 feet, the tree height is 90% of my slope readings, etc.
- Let's say I get +74% to the top, and -22% to the stump.  $74+22 = 98$ . If I am 60 feet from the tree (60% of 100), then tree height is 60% of 90 = 54 feet. If I am 80 feet from the tree (80% of 100), then tree height is 80% of 90 = 72 feet. If I am 120 feet from the tree (120% of 100), then tree height is 120% of 90 = 108 feet.

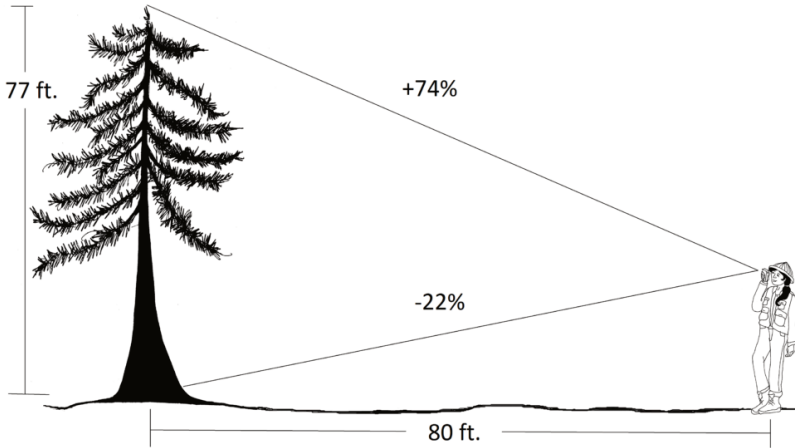

Figure 2.15. A tree is measured from a horizontal distance of 80 feet. Note that the tree height is less than the sum of the two slope readings (98). If one is closer to the tree than 100 feet, the slope readings will be more acute (steeper) than at 100 feet. Therefore, the tree must be shorter than the sum of the readings. Another way to think of it is that 80 feet is 80% of 100 feet, so the tree has to be 80% of the sum of the slope readings. Likewise, if one were 150 feet from the tree, the total tree height would be 150% or 1.5 times the sum of the slope readings.

3. When the canopy is very dense, it may be difficult to discern which top belongs to the tree you are trying to measure. If you have a partner, they can push repeatedly on the tree trunk at arm height. The force will reverberate up the trunk and make the tip wiggle, so you can pick out your tree amongst the other crowns.
4. A good rule of thumb is to walk out a distance that is approximately equal to the tree's height. One should not try to measure 130-foot trees from a distance of 50 feet.
5. When determining height, always record measurements to the precision of your instrument. When holding any instrument to your eye, it is extremely difficult to hold it steady enough to measure between marks. Therefore, heights are always recorded to the nearest foot. Even though a calculator or laser may report

distances and heights to one or two decimal places, the actual precision is not that great due to arm and head movements during measurement.

6. Make sure your run measurement is a *horizontal distance*, not a *slope distance*. An incorrect “run” can result in an incorrect height estimate (Figure 2.16).

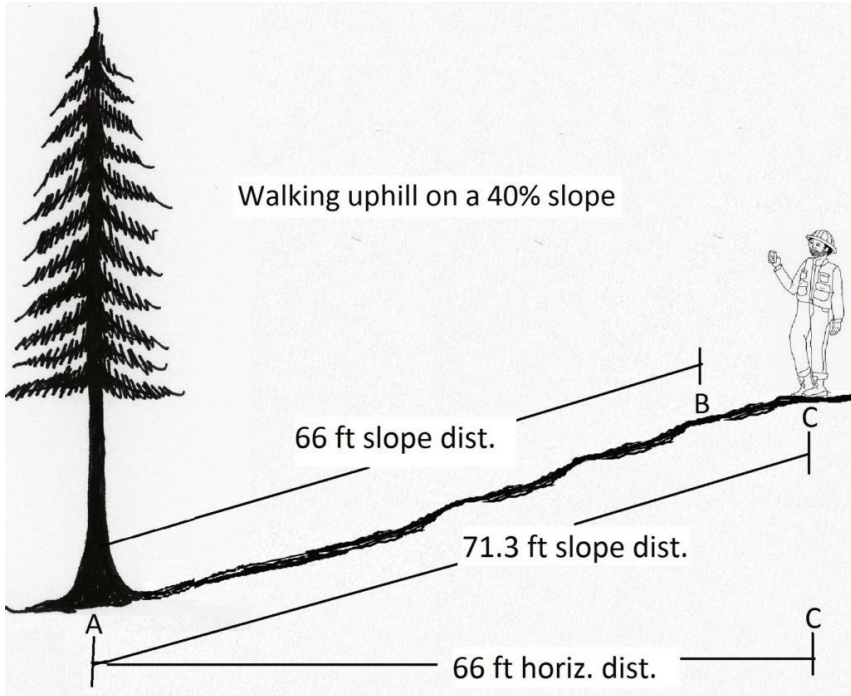

Figure 2.16. Slope distance is always longer than horizontal distance. On this 40% slope, taping out 66 feet parallel to the slope (AB) does not result in a “run” of 66 feet. In order to reach 66 feet horizontal distance (AC), a technician would have to walk 71.3 feet slope distance. Measuring tree heights from Point B would result in an error of nearly 10%.

7. On slopes, walk out from the tree along the contour. Do not walk upslope and especially do not walk downslope (Figure 2.17).

Walking downhill will put you beneath the tree and make the angle to the tree top even more obscure.

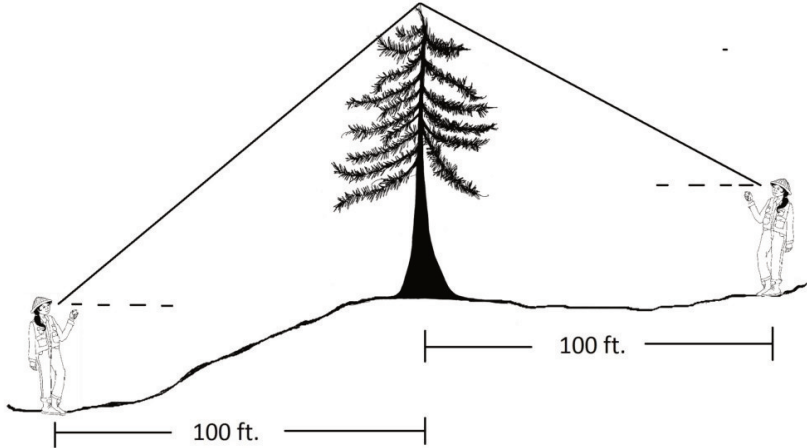

Figure 2.17. Walking downhill from a tree to measure height increases the possibility of mistaking a side branch for the top, thus overestimating the tree's height. In addition, because the top measurement will be steeper than a reading taken from the same horizontal distance on flat ground, it is possible that the slope readings will be "off the scale" on the clinometer.

8. In a pinch, it may be necessary to walk either uphill from the tree or downhill from the tree. In these cases, the *horizontal distance* must be determined, either by using trigonometry, the Pythagorean Theorem, slope distance conversion charts, or a laser rangefinder (Figure 2.16). Also note that if you measure from a place where the stump is below eye level, the bottom slope reading is *subtracted* from the top reading as illustrated in Figure 2.18.

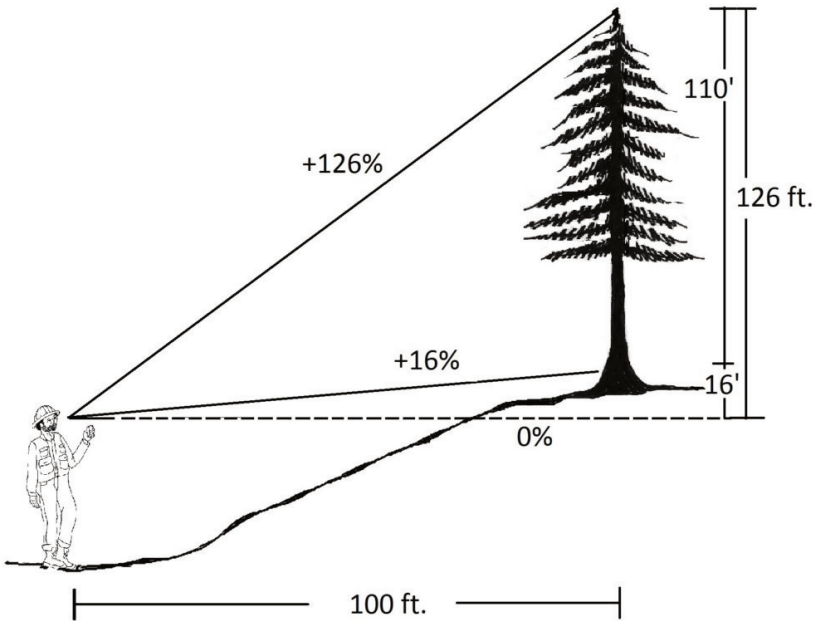

Figure 2.18. Measuring total height from below stump height. Sometimes, a tree may have to be measured from its downhill side. Our slope readings include everything between our eye and the point of measurement. If eye level is below the stump, then our reading to the stump is actually a measure from a point below ground up to the stump. Therefore, we subtract this reading from the top reading (which also includes the ground) to obtain a measure of the actual tree height. In other words,  $(\text{tree} + \text{stump}) - (\text{stump}) = \text{tree}$ . Or  $126 - 16 = 110$  feet.

9. In situations where the brush is very thick, it may be impossible to see the stump of the tree. In this case, sighting on a partner's hard hat or some other target, and adding in that height at the end, will result in a more accurate tree height as shown in Figure 2.19 below. The technician sights to the top of the tree and reads +98%. He then sights to the top of his partner's hardhat and reads +3%. Because he was looking uphill both times, he must *subtract* the second reading from the first to obtain the tree height above

the hat. At 100' horizontal distance,  $98\% - 3\% = 95'$ . He then adds in the height from the stump to his partner's hardhat, or 5' for a total of 100 feet.

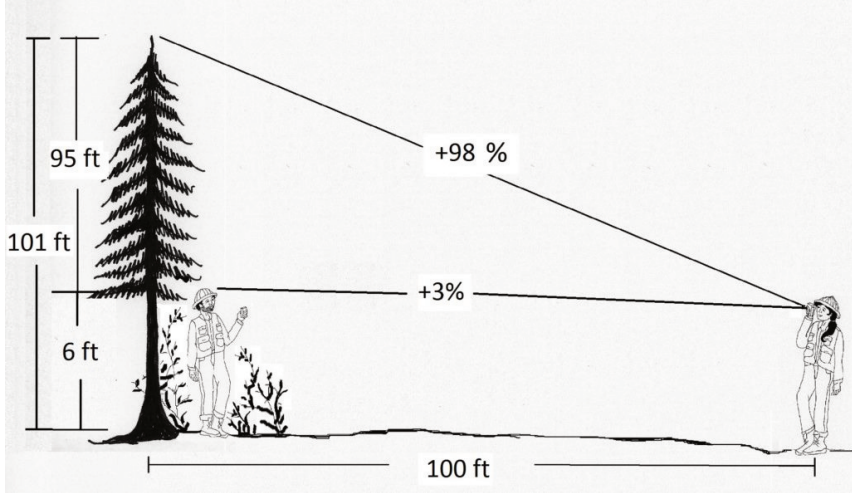

Figure 2.19. Using a partner or target to Determine tree height when brush or ground obscures the tree stump reading.

10. As with all field data collection, when working with a partner, echo back your measurements to make sure the correct number is written down or entered into the data collector.

# Chapter 3: Tree Diameter





## 3.1 Why Tree Diameter?

In addition to satisfying our innate curiosity about how big trees are, measuring the diameter of trees can tell us quite a bit about a forest stand. As we will discuss in a later chapter on “Stand Characteristics,” there is a direct relationship between tree diameter and tree crown. The bigger the tree’s diameter, the greater the amount of foliage it has. Tree diameter data can provide essential information about crown competition, stocking levels, and forest health. Stand management decisions, such as when and how much to thin a stand, rely heavily on data derived from measuring tree diameters. In addition, tree diameter is needed in order to determine a tree’s wood volume.

Look at the “diameter distribution curve” in Figure 3.1 below. Without having ever been to this stand, what can you infer about it by looking at the graph? The curve indicates that there are many small diameter trees around 14”, a group of large trees around 32”, and a smattering of trees with diameters over 50”. Do the groupings indicate different age cohorts? Is the stand approaching an old-growth condition? If we look more closely at the data, we see that the small trees are shade tolerant species, and the less tolerant

Douglas-fir tends to be in the larger size classes. What might that tell you?

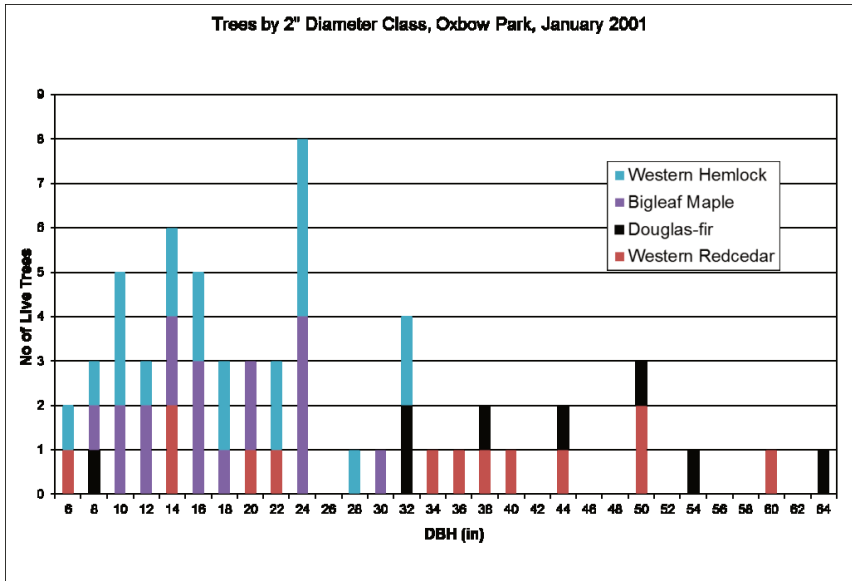

Figure 3.1. Trees by diameter class. Data collected by MHCC Silviculture class January, 2001.

## 3.2 Determining Tree Diameter

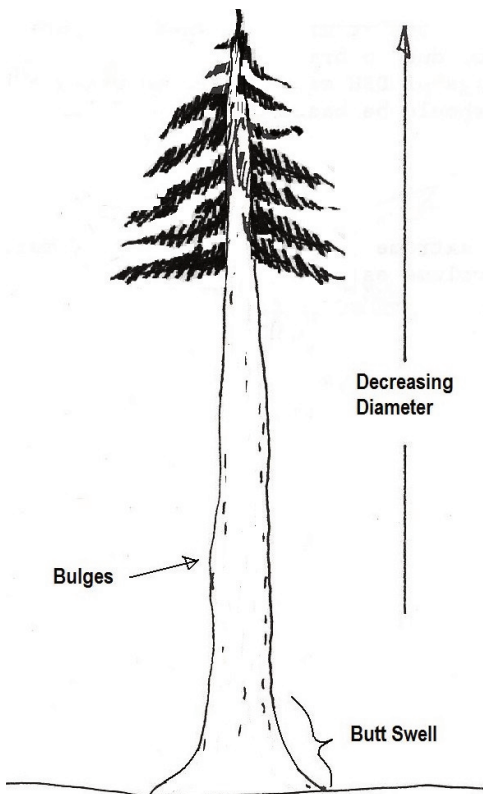

Figure 3.2. A tree showing how diameters are not constant as one moves up a tree.

Trees do not grow like cylinders, but rather taper upward, the tree's diameter getting smaller as one gets closer to the top of the tree. Trees also have **butt swell**, a thickening of the wood and bark at the base of the tree to support the tree's mass (Figure 3.2). Butt swell can create a very large diameter on trees exposed to heavy wind, on steep slopes and in sparsely populated stands. Thus, when you really think about trying to obtain useful diameter data, the question becomes, "where on the tree should I measure it?"

To make tree diameter measurements meaningful and easy to perform, a standard location and protocol have been developed. Diameters are measured outside the bark at **Diameter at Breast Height (DBH)**, or 4½ feet above the ground on the uphill side of the tree (Figure 3.3). This location is above most butt swell, above most of the brush, and is at a comfortable arm position for most people.

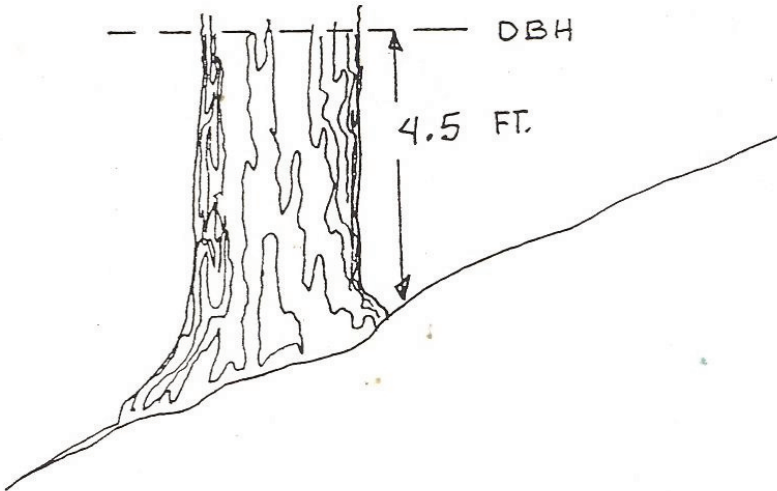

Figure 3.3. The standard location for measuring tree diameter is at DBH, 4.5 feet above the ground on the uphill side of the tree. (From [FS] 1990.)

For most trees in the forest, measuring dbh is quite straightforward. However, there are plenty of irregular trees that require adaptations (Figures 3.4 – 3.10). (All illustrations from or adapted from [FS 1990].)

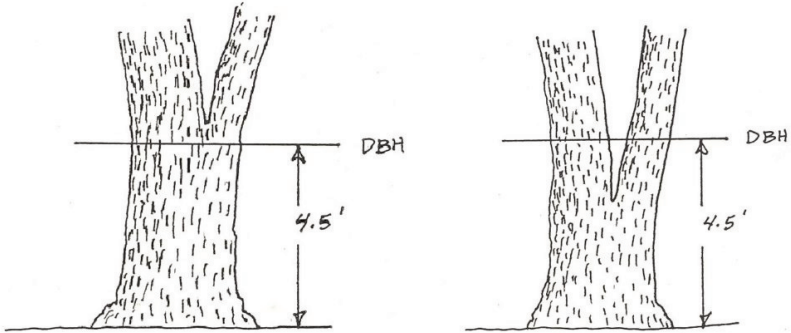

Figure 3.4. On forked trees, measure as one tree if fork occurs at or above 4.5' (left). Measure as two trees if fork occurs below 4.5' (right).

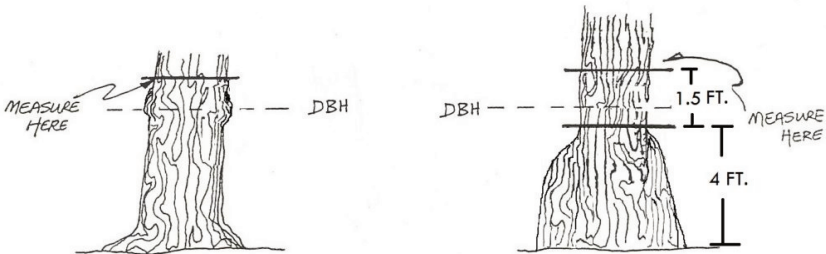

Figure 3.5. Measure directly above a bulge or branch whorl (left). On trees with extensive butt swell, measure at least 1½' above the butt swell (right).

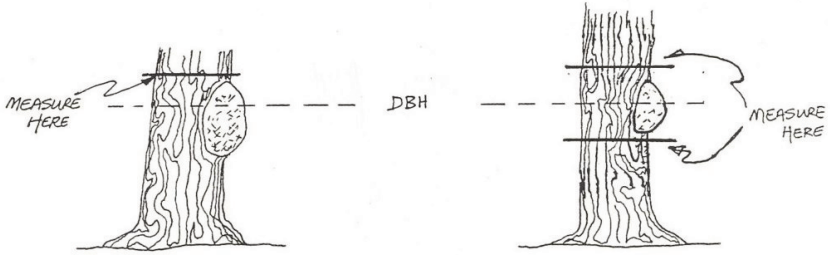

Figure 3.6. For a large burl or canker, measure above the deformity and adjust the diameter down slightly (left), or take two measures equidistant from dbh above and below the deformity, and use the average (right).

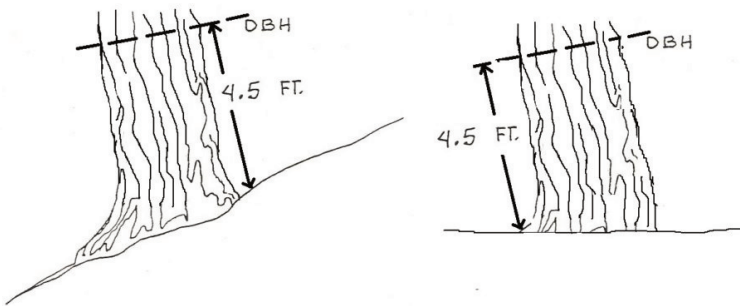

Figure 3.7. On leaning trees, the tape is held perpendicular to the tree bole, and is measured on the uphill side of the tree if on a slope (left); on the short side of the lean if on flat ground (right).

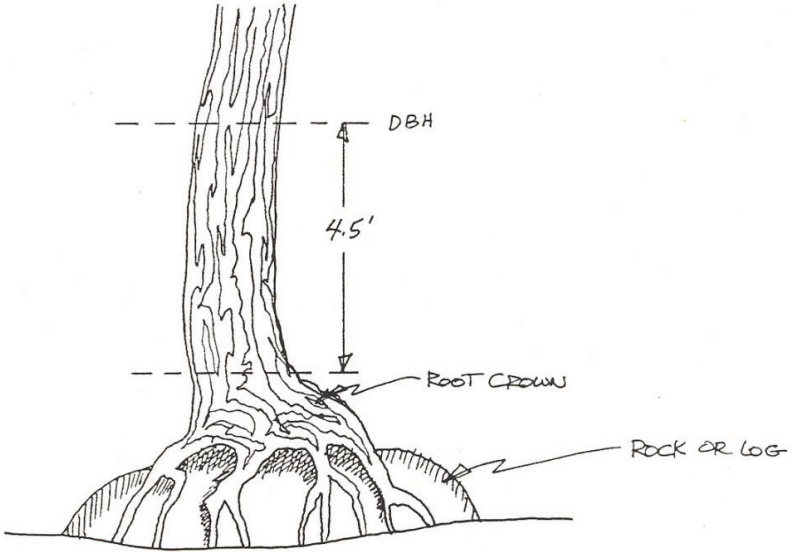

Figure 3.8. On trees with roots above ground, measure at 4.5' above the root crown (below).

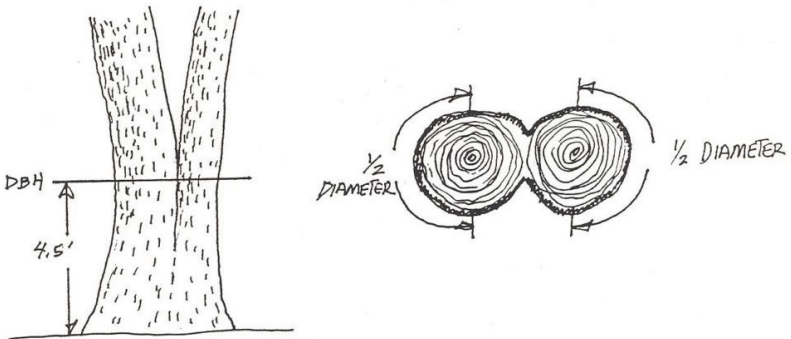

Figure 3.9. On trees that have grown together, count as two trees. Measure halfway around each, and double the measurement.

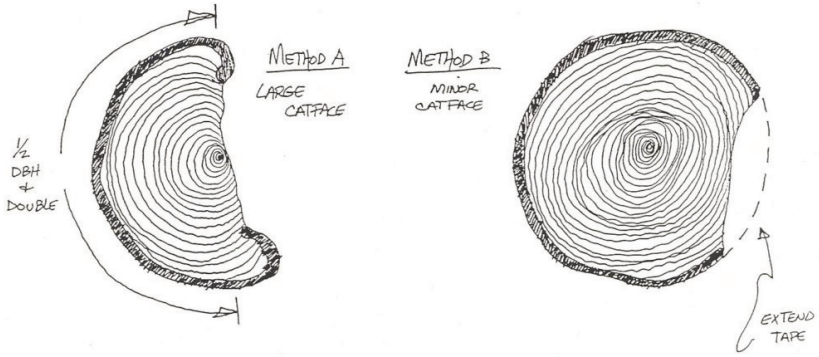

Figure 3.10. On trees with scars, treat as a double tree if severe (left), or reconstruct the diameter if slight (right).



## 3.3 Instruments for Measuring Tree Diameter

A number of different instruments can be used to determine dbh. Each has its merits and should be used according to the situation present.

1. A **diameter tape**, or **d-tape**, is the most common tool. The tape is wrapped around the tree, measuring its circumference. The tape is graduated to reflect a conversion from tree circumference to tree diameter. Thus, we measure circumference, but can record diameter to the nearest 0.1 inch (Figure 3.11). Granted, most trees are not perfect circles, so there is some error in this method. However, except on extremely irregular trees, this method seems to “average out” the tree’s shape to an acceptable estimate.

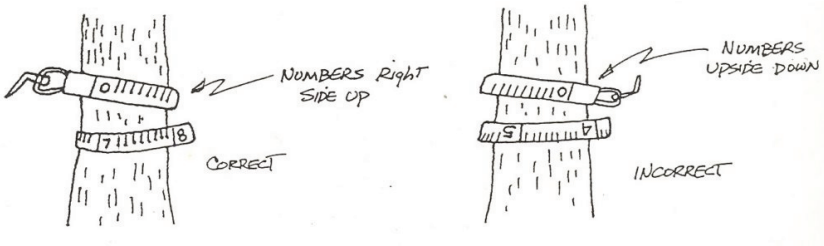

Figure 3.11. A diameter tape is graduated so that diameter can be read from measuring the tree's circumference. (Illustrations from [FS] 1990.)

2. A **Biltmore stick** can give quick estimates of dbh to the nearest 2 inches (Figure 3.12). The slanted edge of the stick is held against the tree 25" from a person's eye. One end of the stick is lined up at dbh with the left edge of the tree. Without moving one's head, the diameter is read off the stick where the line of sight crosses the stick on the right edge of the tree. In general, two measurements should be made on the tree, at right angles to each other, to account for the fact that trees are rarely perfectly symmetrical. The average of the two measures is recorded.

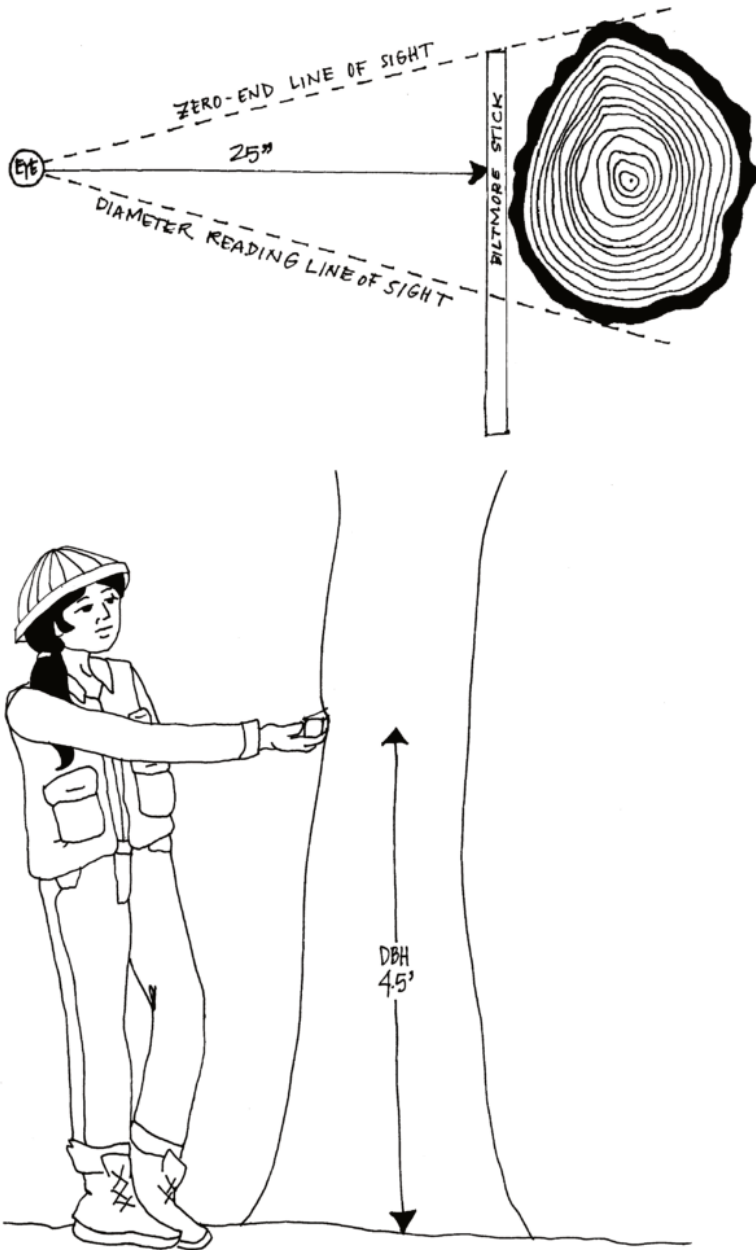

Figure 3.12. Proper alignment of a Biltmore stick to determine dbh.

3. A **relaskop** can be used to determine diameter at any point in the tree. This makes it very useful for measuring merchantable tops, merchantable heights and taper heights in timber cruising. The diameter scales adjust for slope as one looks higher and higher in the tree (Figure 3.13). However, because it is slower and estimates dbh less precisely than a d-tape, this instrument is generally reserved for dbh measurements where you *have to* measure dbh from a distance—either because you physically cannot get to the tree, or because the correct measurement point for dbh on the tree is out of reach.

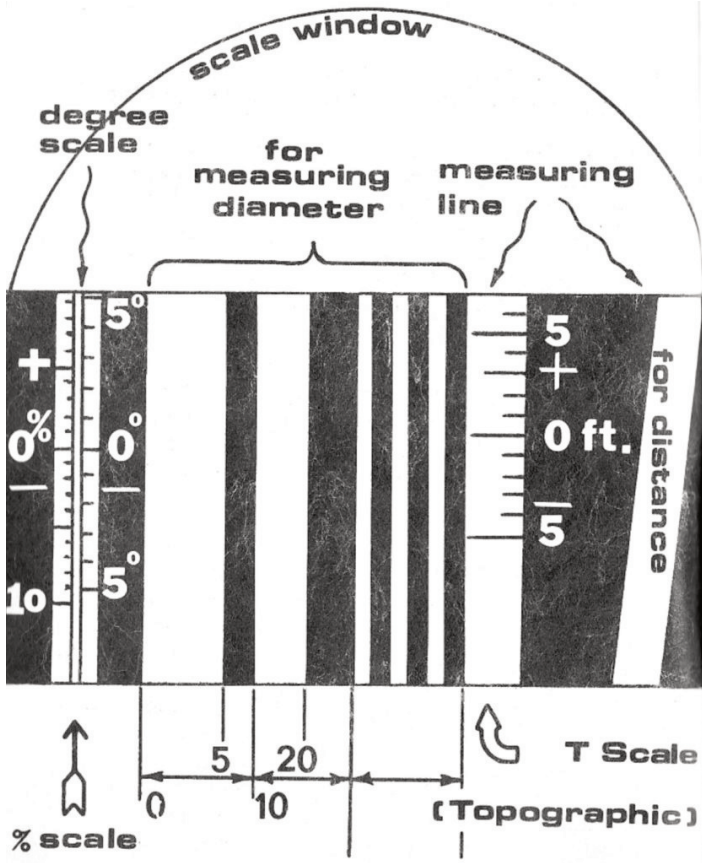

Figure 3.13. A view of the scales inside a relaskop. The black and white vertical “bars” are used for measuring diameter. A %slope scale is found on the far left, and a topographic slope scale, or “Tscale,” is found to the right of the diameter bars. Notice at the “0” mark, the scales are indicated by “0%” and “0 ft” respectively.(illustration from Lemoine n.d.)

4. An **electronic dendrometer** gives a digital readout of diameter at any point in the tree. It is essentially an electronic relaskop.
5. In areas where vines are prevalent, getting a d-tape around the tree or finding a flat side on which to lay a Biltmore stick can be nearly impossible. In these circumstances, a **tree caliper** is handy

(Figure 3.14). A graduated scale corresponds to the width of the caliper teeth. Again, two measurements should be made, at right angles to each other, in order to alleviate error that would crop up in trees that are rather elliptical. The average of the two measures is recorded. Tree calipers are somewhat heavy, and can be cumbersome to carry around all day, especially in heavy brush. Therefore, these are not as popular in the Pacific Northwest as they are in other regions.



Figure 3.13. A tree caliper is held at right angles to the tree trunk. Diameter is read off the left side of the sliding scale at front.

## 3.4 Field Technique Tips for Measuring Tree Diameter

Measuring dbh is relatively easy, but it is important to keep the following in mind while measuring and recording.

1. To speed up your work, determine where dbh is *on your body* and then use that point as a reference for locating dbh on each tree. This is much faster and easier than measuring up 4½ feet on every tree. You may want to check this the first several days you measure to make sure you are consistent. Over time we tend to “slip” a little and measure where it is most comfortable for us rather than at dbh.
2. Make sure the d-tape is level, at right angles to the tree stem. Slack in the tape on the back side of the tree will inflate the true diameter of the tree.
3. When using a d-tape, “hug the tree” to wrap the tape around it. This is much faster and less tiring than hooking the tape and walking around the tree, and you will soon find the diameter limit of your arms. This can come in handy. On large trees, try swinging the tape behind the tree and catching it in your other hand to avoid having to walk around the tree. This takes practice, but is worth mastering. Walking around large trees in heavy brush on steep

slopes, while trying to hold a d-tape at the correct height can get really old really fast.

4. When determining dbh, always record measurements to the precision of the instrument being used. In other words, if we can measure to the nearest 0.1 inch, we record to the nearest 0.1 inch. In this way, we maintain the highest flexibility in using the data later for whatever analyses are needed. So, **DON'T ROUND OFF IN THE FIELD.**
5. Try to guess the dbh before measuring it. You will be amazed at how quickly your eyes will calibrate. This not only makes a game out of the work, but can come in handy in situations where you need to check for errors – and you can impress your friends.
6. Work safely with the d-tape. The hook on the end can injure your hand or eyes, and the edges can give you “paper cuts.”
7. Once the data are brought back to the office, the diameters may be placed into their appropriate **diameter classes**. This is a way of grouping diameters for easier data analysis. Regardless of whether one is using one-inch or two- inch diameter classes, the diameter class “numeral” is always the midpoint of the diameter class. This is the easy way to remember how to assign the correct class. They are grouped as follows:

One-inch classes:

8” class = 7.6” – 8.5”

8.9”

9” class = 8.6” – 9.5”

10.9”

10” class = 9.6” – 10.5”

12.9”

11” class = 10.6” – 11.5”

12” class = 11.6” – 12.5”

Two-inch classes:

8” class = 7.0” –

10” class = 9.0”–

12” class = 11.0” –

and so on.....



and so on.....

Note that if you record “11” in the field, it is not clear if the tree should be placed in the 10” two-inch class or the 12” class. Was the actual measurement 11.2” (12-inch class), or was the measurement actually 10.7” and rounded up to 11, placing the tree in the 12” two-inch class instead of the correct 10” class. So leave the rounding until the data are actually being analyzed. If the field measurement is 11.0”, record “11.0.”

8. As with all field data collection, when working with a partner, echo back your measurements to make sure the correct number is written down or entered into the data collector.



# Chapter 4: Tree Age



## 4.1 Determining Tree Age

How old is that tree? Trees, particularly big trees, fascinate us, and we often want to know how long a tree has been alive. Was it here when Lewis and Clark reached the Pacific Ocean in 1805, or when Oregon became a state in 1859? Did it survive the Columbus Day storm of 1962? Did it germinate and begin its life as a result of the Tillamook Burns or the 1996 floods in the Willamette Valley?

Although we love to ask the question, it is usually nearly impossible to guess the right answer. Tree size, particularly for big trees, is as much a reflection of tree species and growing conditions as it is tree age. Consider a California redwood (*Sequoiadendron sempervirens*). This fast-growing species could easily reach 40 feet in ten years. On the other hand, it may take a lodgepole pine (*Pinus contorta*) twice as many years to reach the same height even if the two species were growing side by side (Burns and Honkala 1990). Nearly any species growing in the sun will grow significantly faster than in heavy shade (Figure 4.1). Grand fir (*Abies grandis*) or Douglas-fir growing in the moist, moderate climate of western Oregon will grow taller faster than the same species in the drier and colder climate east of the Cascade Mts. Knowledge of species, habitat, and available tools and techniques all help in estimating tree age.



Figure 4.1. Douglas-fir seedlings growing in the sun (left) and shade (right). Note the bushier appearance and greater number of needles on the tree in the sun.

## 4.2 Young trees

An approximate age for many young conifers can be determined by “counting the whorls.” Some trees, including most conifers growing in the Pacific Northwest, have *determinate* height growth. This means that they put on one “flush of growth” each year, and that this year’s growth is determined by last year’s bud. The terminal and lateral buds at the tips of the tree break bud, or “flush” in the spring (Figure 4.2). The stems or “leaders” produced by these buds elongate until some time in July, and then set new buds for the following spring.

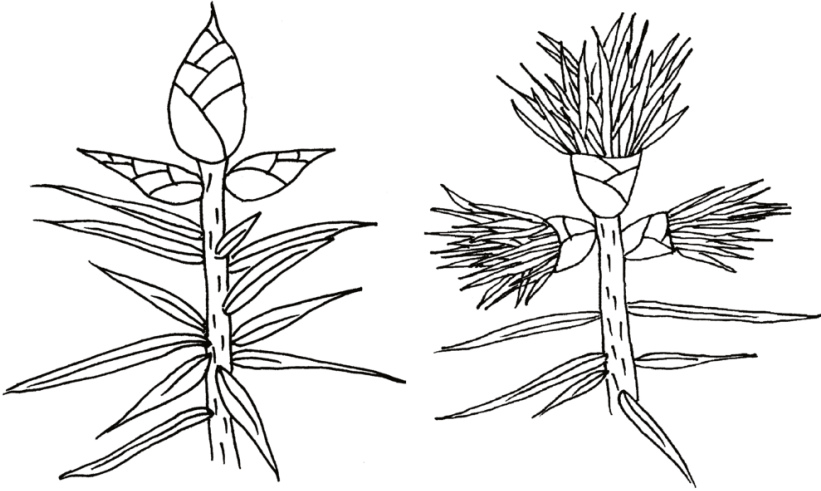

Figure 4.2. Terminal buds at the tip of the stem (left) flush and grow new branches and leaves each year (right). The center becomes the new leader, or main stem. The lateral or side buds become new lateral branches.

A tree increases in height by the length of the new leader growth produced by the terminal bud (from old bud to new bud). In addition, the lateral buds flush and produce a new whorl of branches at the base of the leader (old bud location) (Figure 4.3). This process is repeated every year. Therefore, each whorl of branches and the stem growth immediately above it (up to the next whorl) represent one year of growth.



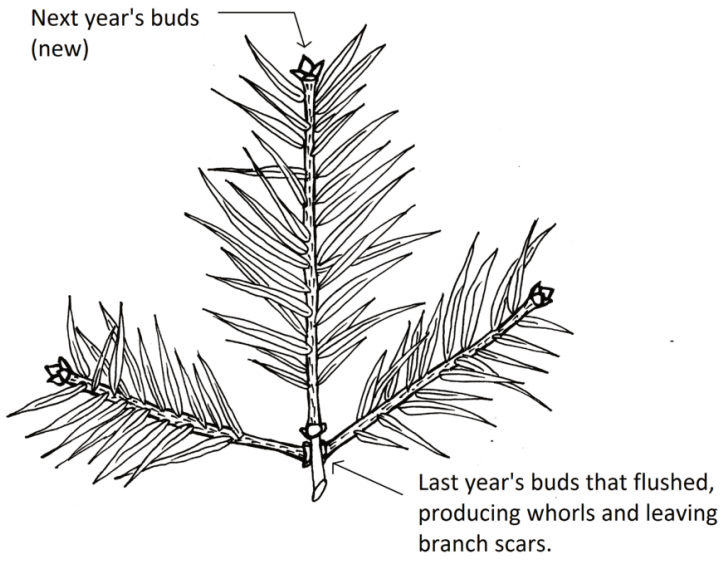

Figure 4.3. An annual flush of growth represents one year, or one whorl of growth.

## 4.3 Field Technique Tips for Counting Whorls:

Because each whorl represents one year of growth, one can estimate age on young trees with determinate height growth by counting the whorls.

1. On most trees, the lowest tree branches are systematically dropped as the tree grows and the sun no longer hits the base of the tree. Therefore, when estimating age using this method, it is important to include the bottom-most stubs and/or knots where it is evident branches once existed.
2. Two to four years should be added to most species to allow for the time between seedling germination and evidence of branch whorls on the trunk (Figure 4.4).
3. Small single branches between major branch whorls do not constitute a true whorl or year of growth. Do not count these false whorls.
4. A very short increase in length between whorls that seems unlike the other years' growth may indicate a "lammas" year, in which the tree flushed twice, often in response to extraordinary growing

conditions. Ignore those years unless it is evident that some injury is responsible for the very short internode (Figure 4.4).

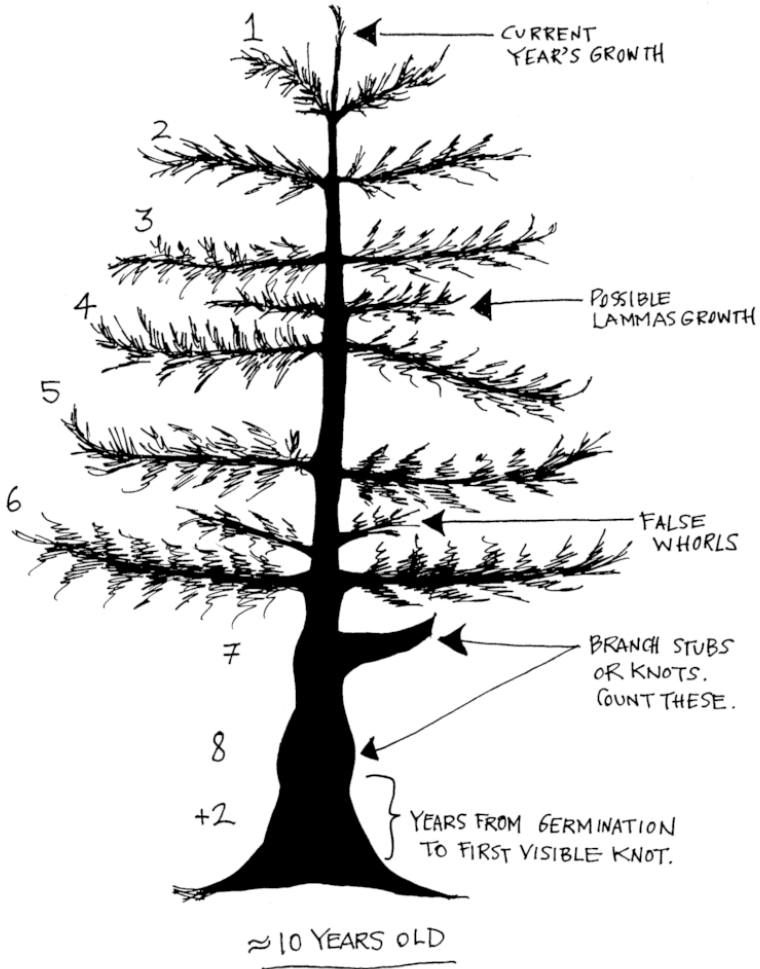

Figure 4.4. Counting the whorls to determine age of a young conifer. Lamma growth and false whorls are ignored. Lower stem is examined for knots, and time to first visible knot is estimated and added in – generally 2-4 years.

This method of “counting the whorls” usually works very well up

to fifteen years of age or so for conifers such as Douglas-fir, spruces (*Picea* spp.), pines (*Pinus* spp.) and true firs (*Abies* spp.). It is more challenging for cedars (*Thuja* spp., *Chamaecyparis* spp.), hemlocks (*Tsuga* spp.), and some hardwoods. One really has to get close to the tree, look carefully for evidence of bud scars, and know the growth habits of the species.

## 4.4 Forest Setting

Larger trees growing in a forest present the greatest challenge. As noted above, it is very difficult to estimate tree age simply from size. So much depends on the tree's microenvironment (access to light, water, space and nutrients), its unique species-dependent growth habits, and the events that alter the tree's environment or health over the course of its life. The frequency and intensity of disturbances such as fire, insect attacks, or windstorms profoundly influence tree growth over time.

Trees growing in managed forests, particularly evenaged "second growth" or "third growth" forests, were likely planted. Foresters record the year of planting and seedling age at time of planting. Most companies will have year of establishment printed on company forest maps or indicated on company aerial photos for ease of use. In these cases, simply researching office records before one goes out to the field will provide stand age.

Trees growing in naturally regenerated stands, unmanaged stands, or stands managed for an unevenaged structure are harder to evaluate. In these cases, individual tree age can vary greatly from tree to tree. Knowledge of tree silvics can help with ballpark estimates. For example, a young (< 30 yrs.) true fir will have smooth bark with

resin blisters. This gradually develops into plates or fissures as the tree ages. A tree over 100 years will have regular, geometric shapes in the bark patterns. The crown of a very old tree will also have a rounded top, different than the tiered leader of a young tree. On Douglas-fir, the smooth bark gives way to thick fissures in the bark. But these type of physical characteristics, without some site history clues, may only get a person to within about 30 years of the actual age.

### **ANNUAL RING COUNTS**

The most direct way of determining tree age is to count the annual rings on a tree's stump or a round "cookie" cut from the tree. In the Pacific Northwest, trees produce one "ring" of diameter growth each year, so the number of rings present on a cross-section of the tree's trunk represents the tree's age at that height. Counting rings on a stump will result in a pretty accurate estimate of the former tree's age. Counting rings from a cookie cut at a height of ten feet or twenty feet will tell you how many years the tree grew after it reached that particular height (Figure 4.5). In fact, researchers examine cookies cut from regular intervals along fallen trees to derive information about species' growth rates, and sometimes to investigate evidence of historical events such as fires, droughts, insect outbreaks, etc. in a science called **dendrochronology**.

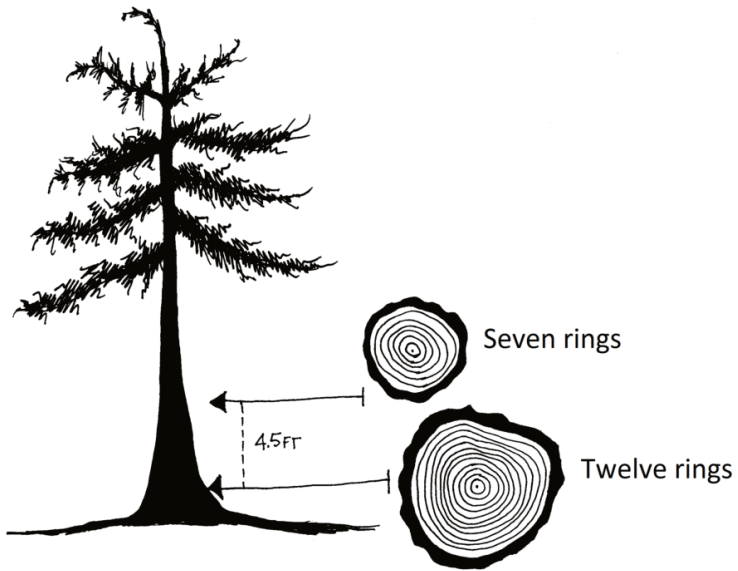

Figure 4.5. A round “cookie” cut at the base of the tree reveals 12 years of growth; at dbh, seven rings are counted, indicating it took five years to grow from stump to dbh.

## 4.5 Increment Boring

Since counting a tree's annual rings is a reliable way to estimate its age when records are unavailable, this method has been adapted for living trees. An instrument called an **increment borer** extracts a small, pencil-sized piece of wood, or core sample, from the trunk of the tree. A mini-auger is drilled by hand from the bark to the center (pith) of the tree, and the resulting core sample extracted from the hole displays the annual rings (or increments of growth) of the tree at that point in the tree (Figure 4.6). The tree then "pitches" the hole over, filling the small cavity with resin.



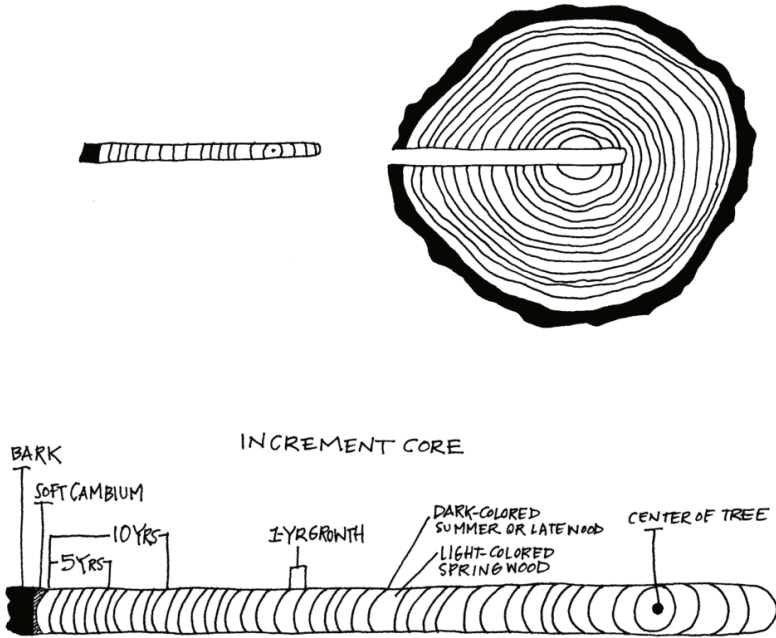

Figure 4.6. A cross-section of a tree that has been bored, showing the displaced core sample.

The standard location for taking increment core samples from a tree is diameter at breast height (DBH). There are a number of reasons for doing so.

- It is a comfortable height for most people to turn the handle of the increment borer, and to extract the core sample. (Imagine lying on your stomach to try to obtain a core sample from a one-foot stump!)
- There is ample room for the borer handle to turn. (At the base of the tree, one would constantly hit the ground or roots of the tree.)
- Brush and other vegetation do not have to be cut away in order to operate the borer.

- There is generally room to avoid oddities in the tree's trunk – branch whorls, cankers, etc.
- Age/diameter relationships can be developed.

Because increment core samples are obtained at dbh, it is important to note on a data sheet that the age estimate is “DBH Age.” If one is using tree age to track growth on a chart or determine site index, it is also important to note whether or not the *chart* uses dbh age or total tree age. If total tree age is required, then the technician must estimate how many years it took the tree to grow to dbh (4.5 feet). This number (usually 4–8 years) is added to the core sample age to estimate total tree age.

## **INSTRUMENTS FOR INCREMENT BORING**

Increment borers are tidy instruments that consist of a handle (that serves double duty as a case), a bit and an extractor. (Figure 4.7). The bit is locked onto the handle, making a “T”-shaped instrument, then twisted into the tree. Once the bit has reached a little more than half-way through the trunk's diameter, the extractor, a thin metal sleeve, is pushed in, then pulled out as described under *Field Techniques for Increment Boring*.

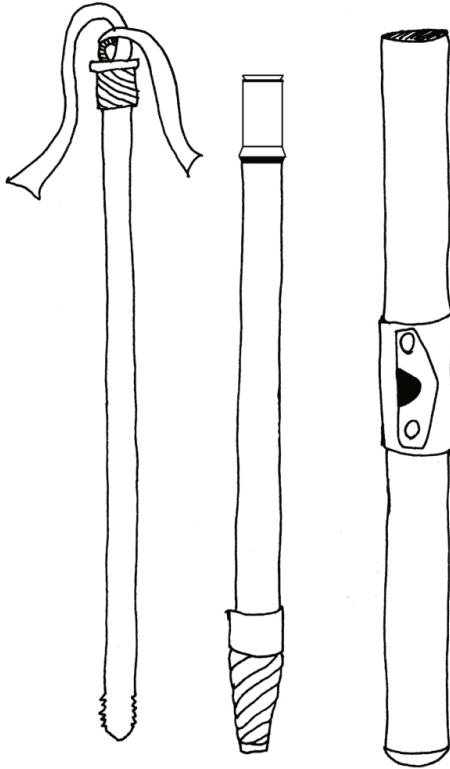

Figure 4.7. Borer extractor (left), bit (center) and handle (right). The square end of the bit is inserted into the center of the handle where the clasp is located.

**Caution:**

Ring counts are not foolproof! For example, many tropical trees and diffuse-porous hardwoods have growth rings that are nearly indistinguishable. Trees may also produce “false rings” during years of unusual weather conditions (e.g. drought followed by high rain, lammas years), or indistinct (missing) rings in years of extreme drought or defoliation. The older the tree, the more opportunities

hofer

there are for abnormalities. Therefore, it is important to remember that we can only obtain *estimates* of tree age.

## 4.6. Field Techniques for Increment Boring

Here are some tips and instructions for getting clean, usable core samples.

**In the office:**

1. Inspect your borer bit! Make sure your bit is sharp and free of nicks. A jagged bit edge will result in a “torn up” core sample. It is extremely important to keep the bit edge clean and protected to get a smooth core sample that you can read easily (Figure 4.8).

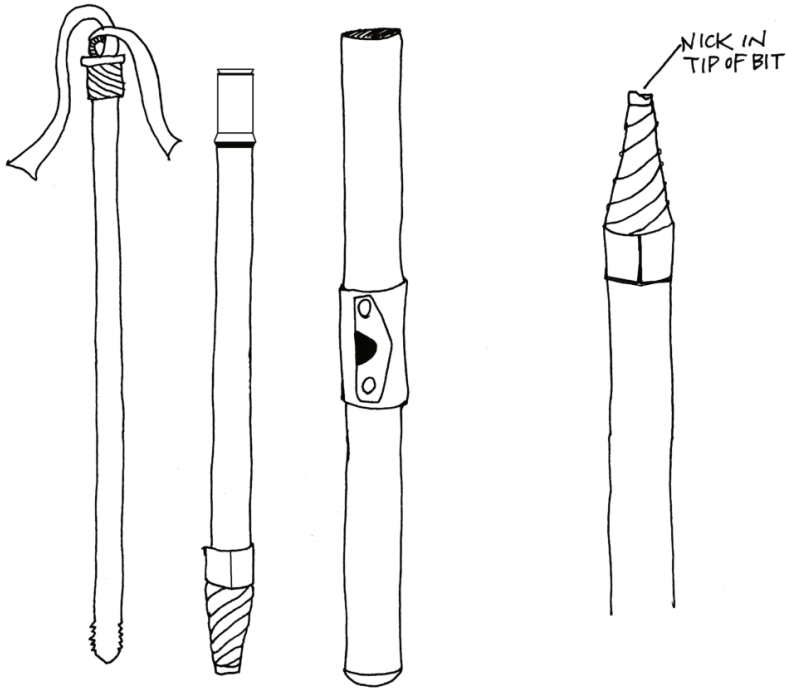

Figure 4.8. The far left image shows a jagged bit surface. This will chew the wood as it bores and result in an unreadable core sample.

**In the field:**

1. Determine dbh. Note – the core sample does not have to be taken from the uphill side of the tree, but *does* have to be taken at dbh. If you are standing on a slope, it is best to bore the tree on the side slope to diminish the effects of its off-center pith.
2. Choose a spot on the trunk free of knots or bulges.
3. Put the extractor in a safe place while you are boring. Never put it in the ground! Abrasion of the extractor teeth by minerals and rock particles in the soil will dull them, making them unable to “grab” the core sample when it is time to extract the core. It is also too easy to lose or step on the extractor when it is under your feet. Some people stick the extractor into the bark of thick-barked trees,

but most manufacturers discourage this as well. A nice place for it is in the pencil slot of your cruiser's vest. It is also a good idea to wrap brightly colored flagging on the end of the extractor to make it more visible. This is particularly important when working in heavy brush.

4. Getting the bit started is often the most difficult part. You will be able to tell when the bit gets through the bark, "catches" the wood and begins to wind its way to the center. Lubricating the bit with beeswax or WD40 can make that initial catch easier to accomplish.
5. Estimate where you think the center of the tree is and bore two or three inches past that point. This accomplishes a couple of things.
  - a) We often misjudge how far to bore. Adding a few inches reduces the chance that one will come up short in trying to reach the pith.

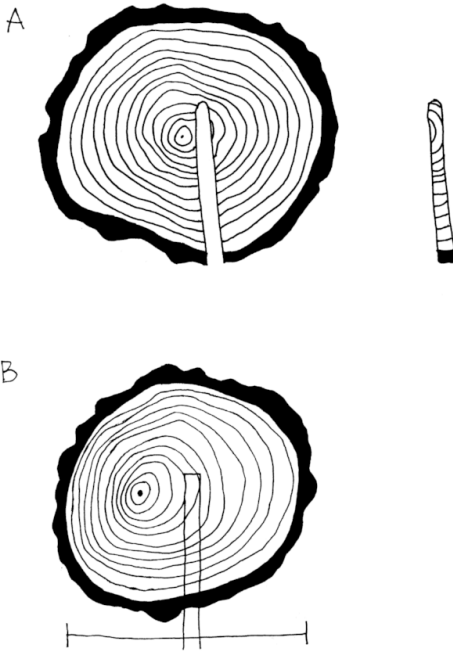

Figure 4.9. (A) Off-center core sample showing curving rings near center. (B) Centered core sample on tree with off-center pith.

- b) Most trees are not perfectly round, nor is the pith always in the geometric center of a tree. A tree growing on a slope or where there are strong winds, will likely have an off-center pith. Boring past the pith will result in a better chance of hitting the center (Figure 4.9).
- c) It is generally easier to tell where the center of the tree is when you can see several rings past the pith. The rings on the core sample will start curving a little when you get close to the center; they then curve the opposite direction once you have passed the pith. Seeing the curves in both directions can help pinpoint the center.



6. After inserting the extractor into the borer, turn the handle in a reverse direction *crisply* to break the wood and allow the core to be extracted. (If the extractor is inserted on top of the core sample, make 1 ½ reverse turns; if the extractor is inserted below the core sample, make two full reverse turns.)
7. It may be difficult to pull the extractor out. Use your foot on the tree for leverage or use two hands, but *never twist the extractor!* This will not help get it out, and will result in a broken extractor. Wear gloves to protect your hands from “paper” cuts as the extractor comes out of the tree.
8. Remember that a growth ring representing one year’s growth consists of both the light colored earlywood (laid down in the spring) and the dark colored latewood (laid down in the summer). It is this contrast of last year’s latewood to this year’s earlywood that allows us to count the rings. Many people train their eye to simply count the dark latewood bands in each ring.
9. A hand lens or magnifying glass will help with distinguishing the rings, particularly on old or slow-growing trees where the rings are narrow. Also, wetting the core sample will make the rings stand out more.
10. If the pith is missed, try to “reconstruct” the center of the tree by placing your core sample on a piece of paper and drawing circles to extend the centermost rings visible on the core (Figure 4.10). Using the width of the growth rings closest to the center as a guide, estimate how many rings are missing from the center, and draw them in. Add these missing rings, if few in number, to the annual ring count. If you are adding more than three or four years, it is best to get a new sample.

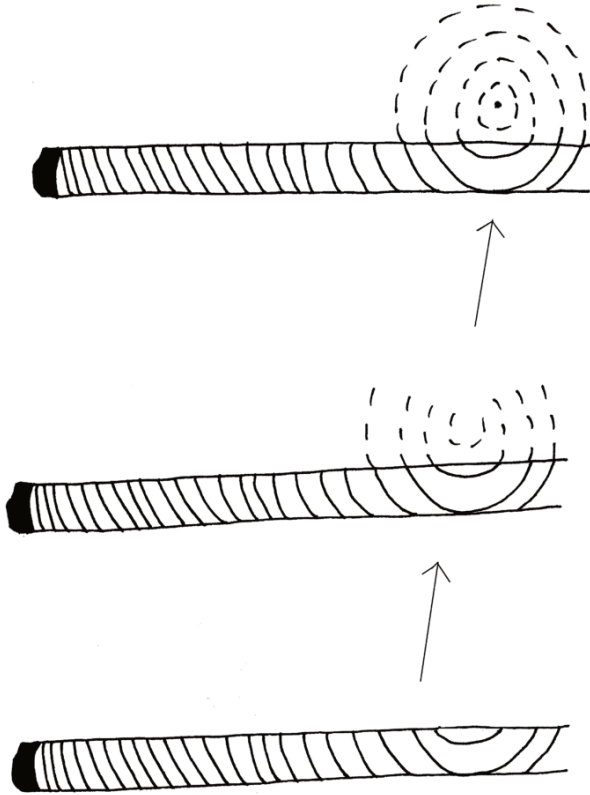

Figure 4.10. Use inner ring width and curvature to reconstruct “missing” center rings. For this core sample, one more year would be added to the ring count.

# **Chapter 5: Stand Characteristics**



# 5.1 Stand Structure

One of the questions we often ask about forests is simply, “What’s out there?” What species are growing there? What does the forest look like visually? Are the trees young, old, or mixed? What is the proportion of small to large trees? Is there a tree canopy with a shrub layer underneath? Is the understory mainly herbaceous plants? Are there several layers of trees? Are snags or large fallen logs present? How dense is the forest? Do the trees have ample room to grow or are they crowded together? Forests display a vast array of species and structural arrangements (Figure 5.1.)

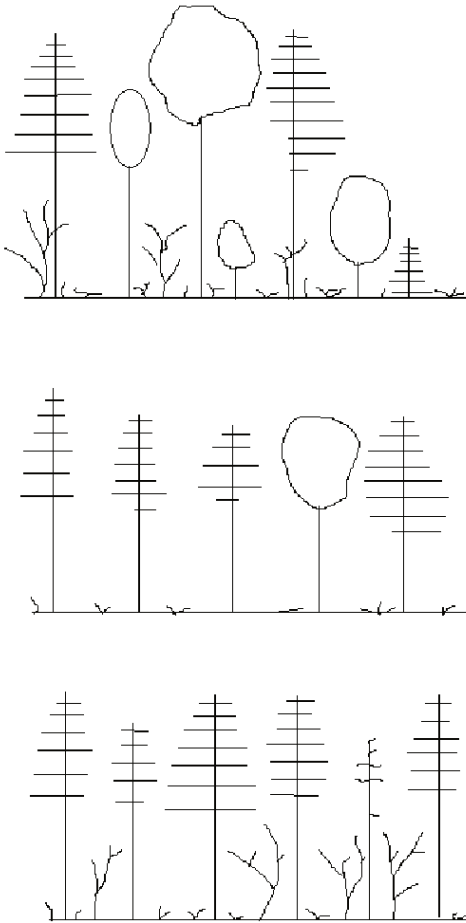

Figure 5.1. Examples of various forest stand structures.

A common task of the forest technician is to provide data to answer these questions. A survey called a “stand exam” is just that – an examination of the composition and structure of the forest. Once an assessment of the current conditions is completed, then questions

about “What’s happening out there?” or “What will the stand look like in the future?” can be addressed more readily.

*Stand Structure* refers to the overall “look” of the forest stand (Figure 5.1). It is the “horizontal and vertical distribution of components of a stand, including the height, diameter, crown layers and stems of trees, shrubs, herbaceous understory, snags and down woody debris” (Helms 1998).

As one might imagine, the structure of a forest changes over time, as trees grow, as fungi rot the wood, as insects or fire move through, as light conditions change, and so on. Therefore, a stand exam is always a measure of the forest at a point in time; a snapshot, not a hard and fast truism. To successfully manage for wildlife habitat, wood quality, desired growth rates and a myriad of other forest management objectives, foresters often a) assess what is present, b) describe what is desired in the future, then c) develop guidelines for managing toward that future forest structure. We can’t wave a magic wand and proclaim, “Increase photosynthesis,” or “Speed up nutrient cycling,” so our current tools for influencing *forest function* center on influencing a forest’s species composition and structural elements.



Figure 5.2. Tree density illustrates the horizontal distribution of trees. The top photo shows a dense forest with many trees (or stems) per acre. The lower photo is less dense, with fewer trees per acre.

Let's look at that stand structure definition again. "...horizontal and



vertical distribution of components of a stand.....crown layers...” What terms can we use to adequately but briefly describe “distribution?” Horizontal distribution can be expressed in measures of *density* – trees per acre or basal area per acre (Figure 5.2). The *crown* is the foliar portion of the plant, and “crown layers” refers to distinct classes or stratification of the canopy. Since trees dominate the canopy of most forests, several forestry terms describe the vertical distribution, or layering of the tree crowns.

An *evenaged* forest is has one or two distinct age or size classes of trees; thus one or two layers of tree crowns(Figure 5.3A).



Figure 5.3A. Evenaged forests: a single layered canopy (left) and a two-aged stand (right).

An *unevenaged* forest has three or more distinct age or size classes, thus three or more layers of trees (Figure 5.3B).



Figure 5.3B. A multilayered uneven-aged stand, with three or more cohorts.

Although it is common to have a canopy of trees overhead, shrubs at midstory, and herbs on the forest floor, we would not refer to this as uneven-aged unless there are several layers of *trees*. A *multistoried* stand is one with multiple layers of trees. As we learned before, tree size does not always indicate tree age; therefore, some foresters try to avoid the terms “even-aged,” “uneven-aged” and “age classes,” and instead refer to forest “size classes” or “cohorts” to describe the distinct tree layers of a forest. So when you *read* “even-aged” *think* “one dominant layer in the overstory.” When you *read* “uneven-aged” *think* “three or more tree layers.”

## 5.2 Crown Classes

*Crown class* is a term used to describe the position of an individual tree in the forest canopy. It can be used in both evenaged and unevenaged stands. Kraft's Crown Classes are defined as follows (Smith et al. 1997 and Helms 1998 modified for clarity):

- **Dominant Trees** These crowns extend above the general level of the canopy. They receive full light from above and some light from the sides. Generally, they have the largest, fullest crowns in the stand (Figure 5.4).
- **Codominant Trees** These crowns make up the general level of the canopy. They receive direct light from above, but little or no light from the sides. Generally they are shorter than the dominant trees.
- **Intermediate Trees** These crowns occupy a subordinate position in the canopy. They receive some direct light from above, but no direct light from the sides. Crowns are generally narrow and/or one-sided, and shorter than the dominant and codominant trees.
- **Suppressed Trees (Overtopped Trees)** These crowns are below

the general level of the canopy. They receive no direct light. Crowns are generally short, sparse, and narrow.



Figure 5.4. An illustration of crown classes. “D” = Dominant; “C” = Codominant; “I” = Intermediate and “S” = Suppressed.

“General layer of the canopy” refers to the size class or cohort being examined. Crown classes are most easily determined in evenaged stands, as depicted in Figure 5.4. In an unevenaged stand, a tree would be compared to other trees in the same layer. Crown classes are a function of tree vigor, tree growing space, access to sunlight (functions of stand density), and species shade tolerance. A “suppressed” Douglas-fir tree is likely of low vigor and will probably die out. It typically would not be able to respond to an increase in sunlight if a neighboring tree fell over. A shade tolerant “suppressed”

western hemlock on the other hand, may survive very nicely and be able to take advantage of increased sunlight if a neighboring tree were to fall over.

Crown class can also tell us something of the overall vigor of an evenaged stand. If most trees are in the intermediate crown class, then the stand is likely too crowded and the trees are stagnated. A stand with nearly every tree in the dominant category is either very young, and all of the trees are receiving plenty of sun, or very sparse and may be considered “understocked.” A typical evenaged stand has the majority of trees in the codominant class, and the fewest trees in the suppressed class. The relative ratios of dominant and intermediate classes are generally a function of species composition. Examine the data in Figure 5.5 and Table 5.1 below.

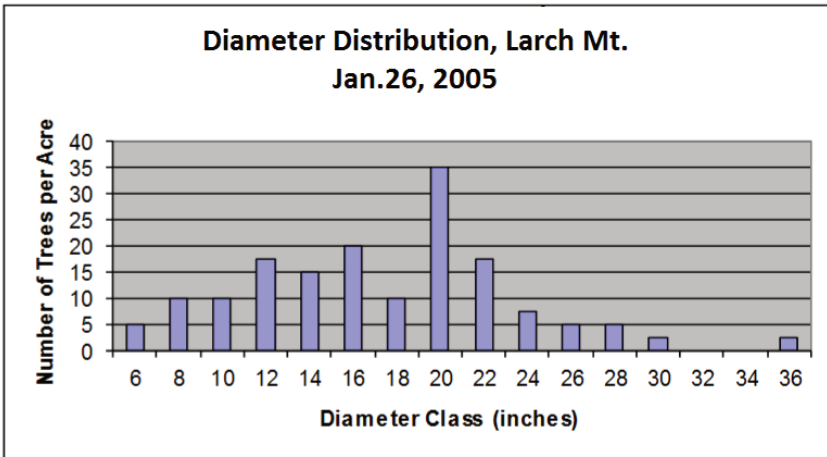

Figure 5.5. Diameter and crown class data for an evenaged stand near Larch Mountain. Data collected by MHCC Forest Measurements I class on January 26, 2005.

This 60-yr old stand of primarily Douglas-fir and western hemlock, displays a bell-shaped diameter distribution, typical of an evenaged

stand. Most of the trees are clustered around the average DBH, with some smaller and some larger than the center range.

<b>Table 5.1. Percent of each Species by Crown Class. Data collected in evenaged stand near Larch Mt. by MHCC Forest Measurements I class on January 26, 2005.</b>				
Species	Dominant 29% of all trees measured	Codominant 35% of all trees measured	Intermediate 24% of all trees measured	Suppressed 13% of all trees measured
Douglas-fir	67	64	40	12
Western hemlock	33	36	60	88

Note that the majority of trees are in the codominant crown class (35%), which most likely makes up the bulk of the 16”-22” trees. It is interesting to examine the species composition data. The majority of dominant and codominant trees are Douglas-fir, while the intermediate and suppressed trees are primarily shade tolerant western hemlock. Therefore, many of the trees in the small diameter classes (6’-10”) may survive over time, even though they are surrounded by large trees. So there is another element to examine besides position in the crown.



## 5.3 Live Crown Ratio

Another useful measurement to indicate tree vigor is **live crown ratio (LCR)**. It is the ratio of crown length to total tree height, or the percentage of a tree's total height that has foliage (Figure 5.6).

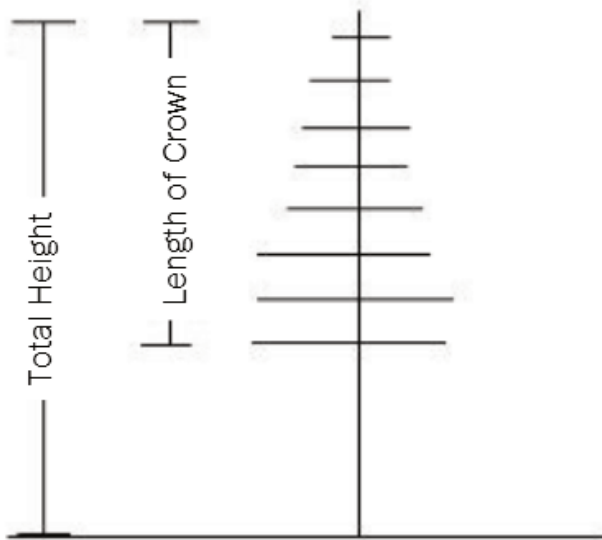

Figure 5.6. Live Crown Ratio: the ratio of live crown to total tree height; expressed as a percentage.



$$\text{Live Crown Ratio} = \left( \frac{\text{length of crown}}{\text{total tree height}} \right) (100)$$

Crown length is partly a function of species' shade tolerance. For example, Douglas-fir and most pines will self-prune (drop their lower branches as they become shaded). However, a shade tolerant species such as western hemlock will keep its lower branches in medium shade. Therefore, a western hemlock will have a longer crown (and higher LCR) under low light conditions than a Douglas-fir. Consider the data in Table 5.2. This young, evenaged forest stand ( $\approx$  40 yrs), had a substantial riparian component supporting the hardwoods, and was growing on a southern slope. Note that the red alder, cherry and Douglas-fir had shorter LCR's than the more shade tolerant hemlock and cedar. The hardwoods were shorter, but all the conifers were approximately the same height.

**Table 5.2. Mean live crown ratio (LCR) and height by species for an evenaged stand in the Latourell Creek watershed. Data collected by Mt. Hood Community College Forest Measurements I class March, 2003.**

Species	LCR(%)	HT (ft.)
Red alder	40	62
Bitter cherry	28	52
Douglas-fir	43	74
Western redcedar	74	80
Western hemlock	64	78

Douglas-fir trees with large crown ratios (>50%) tend to be dominant trees, and/or trees growing with adequate light. Douglas-fir trees with ratios less than 30% generally have low vigor, and typically either a) occupy intermediate or suppressed crown classes, or b) are

growing in very dense, uniform young stands. In the latter case, their root systems do not develop well, and the trees become subject to windthrow over time. These “dog hair stands” are often a result of planting seedlings at a high density, and failing to thin them later at the appropriate time.

In general, LCR will reflect crown class, regardless of species. Trees growing in the dominant crown classes tend to have the longest crowns overall, followed by trees in the codominant, intermediate, and suppressed crown classes respectively (Table 5.3). The exception to this may be unevenaged or two-aged stands in which distinct second and third layers are composed primarily of shade tolerant trees. In these cases, each layer must be evaluated independently.

Table 5.3. Mean live crown ratio (LCR) for species in an evenaged BLM stand near Larch Mountain. Data collected by MHCC Forest Measurements I class January 2003.				
	Mean LCR by Crown Class			
Species	D (%)	C (%)	I (%)	S (%)
Douglas-fir	48	47	38	
Western hemlock	50	37	39	35
Overall	49	42	38	35

## 5.4 Field Technique Tips for Determining Crown Class and LCR

### DETERMINING CROWN CLASS

1. Crown class identification is somewhat subjective, so it is important to try to stick to the definitions and be consistent. Certainly, there will be many trees that do not fit neatly into the classification scheme, so expect some challenges and assign the crown class that most clearly illustrates the condition of the tree or its place in the stand.
2. This is particularly true when it comes to “suppressed” trees. They are still part of the canopy; they do not make up a second layer. Therefore, they do not have to have their entire crowns below the *lowest branches* of the tree canopy. Figure 5.7 illustrates a realistic interpretation of the definition.



Figure 5.7. A simplified view of trees in different crown classes in an evenaged pure stand. The letters D, C, I and O denote dominant, codominant, intermediate and overtopped respectively.

Note the suppressed trees extend into the canopy (after all they are in the same cohort or are the same age as the others); they just do not receive any direct light. The low vigor and poor crown condition of a suppressed shade intolerant tree will be very different from that of an intermediate, and should be documented as such.

### **DETERMINING LIVE CROWN RATIO**

1. Never “eyeball” LCR without measuring. You will underestimate the crown ratio. Standing on the ground, we get a foreshortened view of the crown; it will look shorter to us than it really is. The closer one is to the tree, and the taller the tree, the more your eye

- is tricked. In fact, it is an interesting exercise to guess what you think the LCR will be, then measure it, and see how close you are.
2. Determine length of crown using the same measuring techniques and equipment that you use to estimate total height.
  3. It is sometimes difficult to determine where the base of the crown is. Brush or limbs from other trees may obscure it, or one side of the tree may have limbs lower than the other side. Try to get to a spot where you can see the tree to take care of the first problem. The standard for handling an uneven tree base is to sight on a spot that is halfway between the lowest branches on each side of the tree – “split the difference” so to speak (Figure 5.8).

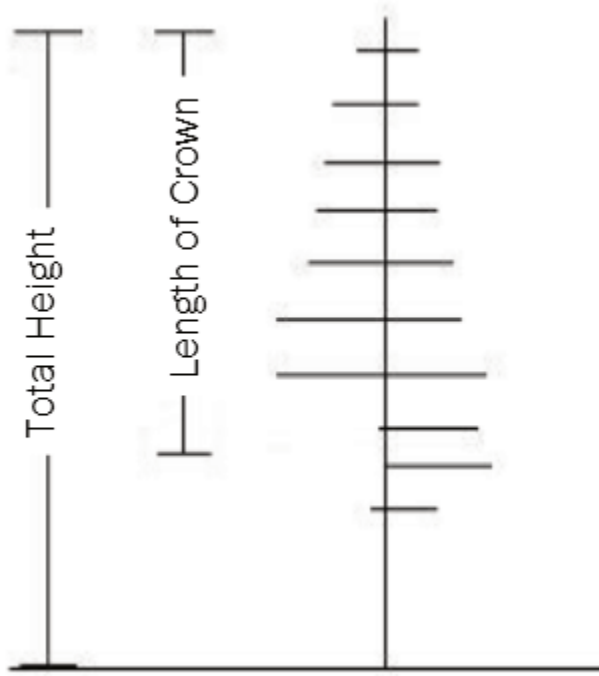

Figure 5.8. Estimating LCR when crown base is uneven. Measure the base halfway between the lowest significant branches on each side of the tree.

4. Ignore a lone live branch that is by itself low on the tree, and clearly not part of the overall crown.
5. Live crown ratio is generally recorded as a whole number (%), not a fraction in decimal form. And as always, record to the precision of the instrument used. We cannot accurately measure to a tenth of a percentage. (Calculator reads 53.6? Record LCR as 54).

## 5.5 Stand Growth and Development Over Time

In addition to giving us a snapshot of current stand conditions, stand exams can also provide clues to stand development over time if conducted periodically on the same site. Tree density, species composition, crown class distinctions and live crown ratios are all interwoven, and their relationships evolve over time to paint a picture of stand development. Although this is the subject of future ecology and silviculture classes, a brief introduction here will give you a better understanding of the crown dynamics you observe as you are measuring in the forest.

Evenaged stands typically originate after large-scale disturbances occur on a site – wildfire, harvesting, windthrow, etc. Resulting forest development tends to follow a pattern of progression through four or more identifiable stages as described by Oliver and Larson (1996):

**Stand initiation or open shrub stage:** the open condition after disturbance allows colonization by a variety of plants. Forest floor herbs, shrubs and seedlings may have survived the disturbance, as well as new individuals and pioneer species that appear over a period

of several years. This is generally a period of diverse species composition. Planted seedlings are part of this stage (Figure 5.9A below).



Figure 5.9A. The open shrub stage is dominated by shrubs, grasses, and seedlings.





Figure 5.9B. The stem exclusion stage is typified by low levels of understory vegetation.

**Stem exclusion stage:** crown closure occurs as tree crowns touch and available growing space is occupied. Overstory competition for light and growing space intensifies, and roots compete for soil moisture and nutrients. Some species die out and understory

seedlings become scarce. This is generally a period of low biodiversity (Figure 5.9B).

**Understory reinitiation stage:** small gaps of light in the canopy are created by breakage or death of individual trees – those lost to suppression, pests, windthrow, etc. This creates an opportunity for new species or individuals to establish in the understory, or for shade tolerant saplings already established in the understory to grow quickly into the gap. This stage generally contains more plant and animal species than the stem exclusion stage, but fewer than the stand initiation stage (Figure 5.9C).



Figure 5.9C. In the understory reinitiation stage, saplings occupy pockets of light that develop in the understory.



Figure 5.9D. The old growth/complex stage is multistoried with woody debris on the ground.

**Old-growth stage:** large overstory trees are replaced by younger understory trees. As the original cohort making up the crown gradually dies, very large gaps allow the trees in the lower forest layers to grow into the canopy. This happens in an irregular fashion, so a multilayered structure emerges. This is the stage of the greatest

structural diversity, and is complemented by high species diversity (Figure 5.9D).

During all stages of stand development, plants are competing for light, nutrients, water, and growing space. Different species have different strategies for maximizing their ability to accumulate these resources, but the reality is clear; there is only so much to go around. During the stand initiation or open shrub stage, the forest may be dominated by herbs, shrubs and small seedlings. During this time, shrubs may grow the fastest, often outcompeting trees for sunlight. Seedlings overtopped by shrubs will die out, but the trees that grow taller than the shrubs begin to dominate the light source. As they fill out their crowns and get big enough to touch each other, crown closure occurs. Trees generally have high LCR's and nearly all occupy dominant crown classes as the stand enters the stem exclusion stage. Competition between trees for light becomes particularly intense during this stage, as nearly all the crowns are about the same height and size. Light to the understory is drastically reduced, as evidenced by the limited number and abundance of understory plants.

As trees continue to grow, they require more physical space for branch and crown expansion, and differentiation into crown classes becomes evident. The healthiest trees, able to grow faster and occupy more space, become the dominant trees. Slower growing trees become codominant, and inferior trees lag behind, creating the intermediate crown classes. These trends become more and more pronounced with time. Large dominants remain dominant, while those that are not as competitive become codominant as their LCR's shrink. Some codominants are outcompeted and become intermediates, while the weakest trees become suppressed and eventually die. This is called *self-thinning*, and continues throughout

the life of the stand as the trees get larger and larger (Figure 5.10). Thus, an area initially supporting 600 seedlings per acre may only support 200 trees per acre when they reach 50 years, or 30 trees per acre by the time they reach old-growth.

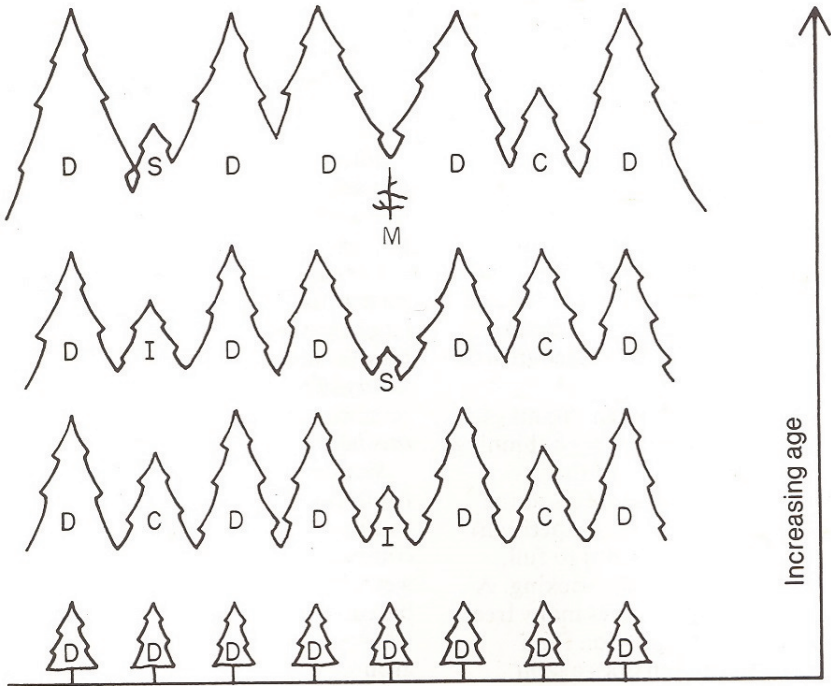

Figure 5.10. Trees differentiate into crown classes with time, as competition for growing space increases. (Emmingham and Elwood 1993)

A direct relationship exists between a tree's diameter and its leaf biomass. The greater the volume of space a crown occupies, the more foliage a tree can support, and the more light it can capture. The more sugar it produces from those leaves, the more energy it has available for growth and the more wood it can produce each year. On the other hand, the smaller a tree's crown is, the less space it has

for foliage, and the smaller its growth rings will be. Thus we arrive at the diameter distribution in Figure 4-5. There is a range of diameters from 6"-36", even though all trees are in the same canopy layer or cohort. Subordinate crown classes in the overstory with low LCR's account for the small diameter trees, and dominant trees make up the larger diameter classes.

A fascinating exercise that demonstrates the interrelationships among neighboring trees as they compete for light and growing space over time, is to chart individual tree diameter growth from increment core samples. The growth rings reflect individual tree crown expansion, and can help explain why some trees become dominant, while others are classified as intermediate.

The illustration below shows diameter growth of four Douglas-fir trees growing side by side in an evenaged stand (Figure 5.11). Cores were taken at dbh, so no data are available to chart how many years it took each tree to reach dbh or which year each tree germinated and began to grow. But as you can see, the tree classified as intermediate (Tree10), *appears* to be about 10 years younger than the other three trees, and although its growth rates are on par with the other trees for the first 15 years, its curve flattens off after 1973, revealing its inability to capture much crown space, even though it occupies the same canopy layer as the larger trees. (This tree illustrates why *even-layered* is not necessarily *evenaged*, and why the term "cohort" rather than "age class" is preferred by some when discussing forest structural layers.) The dominant tree (Tree 11) maintains its high growth rate throughout its lifespan, and really pulls away from the other trees after 1983. The codominants (Trees 14 and 15) display early growth equal to dominant Tree 11, then taper off over the last 25-30 years. It is likely that the stem exclusion stage began around 1968, and the

effects of the more intense competition for light and growing space become evident over the following 5 -10 years.

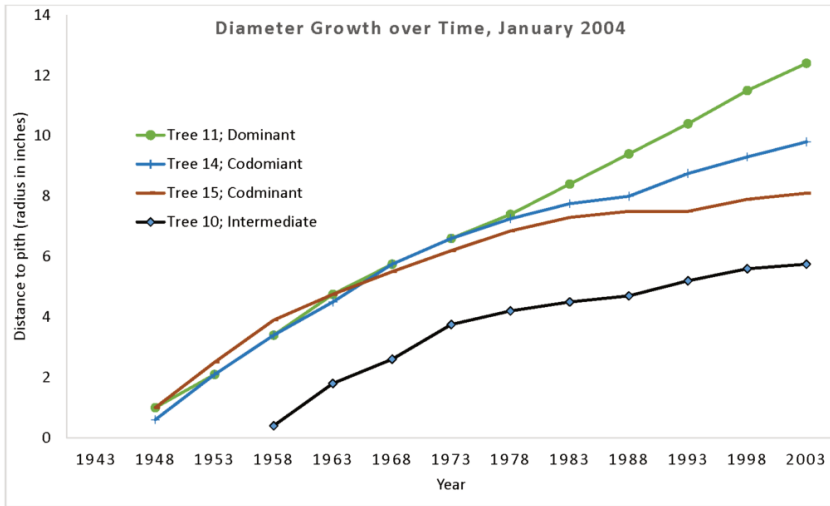

Figure 5.11. Diameter growth of four neighboring trees over time, taken from core samples. Data collected in an evenaged stand on a west slope by MHCC Forest Measurements I students January 2004.

There are two interesting sidelights to observe with the codominant trees. Look at Tree 14. Its growth is similar to dominant Tree 11 until a sharp decline starts in 1968. Was there an event between 1968 and 1973 that would have resulted in a sudden loss of growth during that period? Many trees in this stand showed crooks in the trunks at about the same height, indicating that perhaps the 1969 ice storm caused top breakage in the stand. However, the last 15 years show that this tree has recovered, and is again displaying fairly rapid growth. Codominant Tree 15 on the other hand, shows a gradual slowdown and relatively flat growth rate since 1983. Does this indicate lower vigor? Will this tree ultimately become an intermediate tree as the surrounding stronger trees garner more and

hofer

more light and growing space? At this point, it certainly appears that it is losing ground to the other trees. It is amazing what you can learn from four cores samples!



## 5.6 Application of LCR and Crown Class in Forest Management

*Live crown ratio* and *crown class* are descriptors of tree crown characteristics and indicators of tree vigor. One of the ways that foresters use these terms is to communicate decisions about stand management. For example, let's say a forester wants to improve stand vigor by doing the following:

- reduce incidence of mortality by reducing tree density
- concentrate growth on the healthiest trees
- remove trees with evidence of disease

These are general concepts and overall directions for the stand. But how does one decide *which* individual trees to cut or leave, and how does one *communicate* that information, especially to a *crew* of people marking the trees? Each acre of ground and each individual tree in the forest are unique. Until one actually walks through the entire stand, decisions about individual trees cannot be made. So a set of

*specific* directions describing cut and leave trees must be written to more clearly explain a forester's intentions.

Therefore, in writing a *prescription* for the stand management described above, a forester would use standard terms to describe the intended management outcomes. For example, the following directions might be part of the marking directions.

- Reduce tree density to 75 Trees per acre. On average, space trees  $\approx 24'$  apart.
- Leave primarily **Dominant** trees; second preference is for **Codominant** trees with **LCR**  $> 40\%$ .
- Favor trees with intact crowns.
- Remove trees with evidence of disease or deformity.
- Remove primarily **Intermediate** and **Suppressed** trees.
- Remove primarily trees with **LCR**  $< 30\%$ .

In this way, the person making the cut and leave decisions on the ground has a much clearer idea of how to achieve the objective to “improve stand vigor.”

# Chapter 6: Site Quality



# 6.1 Forest Site Productivity

Just as a farmer might wish to know how “good” his ground might be for various crops, so a forester will wish to know how “good” his forest land is. Since forests are dominated by trees, this generally translates to predicting how well trees will grow. Decisions about what species to grow, how intensely to manage the trees, or whether or not trees are the best crop for a particular piece of ground, are all tied to how plants grow on a site. For example, temperatures may dictate a shift from Douglas-fir to noble fir (*Abies procera*) once a certain elevation is reached. Trees growing on a very productive site may be thinned more frequently over a rotation than trees growing on a less productive site. Marginal pine forestland may be more suitably managed for wildlife habitat than for timber.

*Site quality* refers to the *inherent ability* of a forest to produce biomass (or grow trees). It is the composite expression of a variety of physical and chemical attributes of a forested area, including its soil, topography and climate. Site characteristics such as:

- soil depth, texture, and fertility;
- slope, aspect, and elevation; and
- precipitation, temperature and length of growing season;

all combine to influence how well trees grow (Figure 6.1).

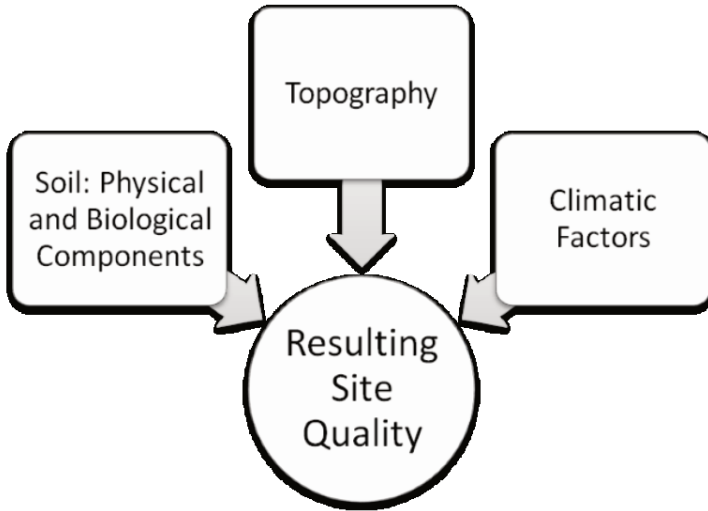

Figure 6.1. A number of site factors combine to influence site quality.

(Note: many people use the terms *site quality* and *site productivity* interchangeably. Purists, however, prefer “site quality” as a baseline indicator, as the productivity of a site can be altered by fertilizing, irrigating, mulching or altering the soil makeup.)

To obtain a measure of site quality, one might first think of examining these site variables and correlating them to tree growth. There have been some attempts at doing just that, but the amount of work and expense required to get meaningful data are generally too great for the range of conditions found in most forest ownerships. Some larger companies, such as Weyerhaeuser, have inventoried and classified their soils, and the Forest Service has developed plant associations to indicate site conditions, but neither may be available for the majority of land managers.

Intuitively, if one is interested in tree growth, then one solution is simply to measure how trees grow on the site. When measuring the trees, correlations are not required; the summation of all variables that influence tree growth is expressed in the biomass itself. The “proof is in the pudding” so to speak. And although the causal reasons for the productivity are not identified, as would be the case if all the influential variables were measured, a reliable indicator for tree growth on the site can be obtained. The question then becomes, “What is the best way to measure tree growth?”

Many measurable tree growth attributes are strongly influenced by stand density. If few trees are present on a site, the individual trees will have large crowns, and thus large diameters and wide growth rings. Conversely, trees of the same age in a denser stand will have narrower crowns, smaller diameters, and tighter growth rings (Figure 6.2).

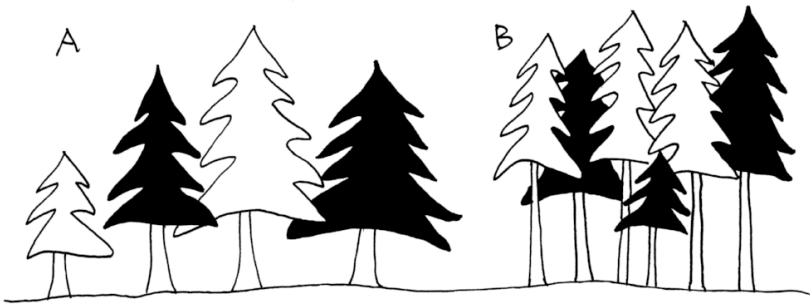

Figure 6.2. (A) Trees with ample crown space have larger diameters, while (B) those spaced close together have narrower crowns and thus smaller diameters.

Since tree volume is a function of tree diameter and height, volume

is also tied directly to stand density. Therefore, diameter, crown volume, tree volume or tree ring growth do not make good measures of overall forest productivity. Average tree height, on the other hand, is not confounded in this manner except at extreme densities. Tree height is relatively independent of tree density for most forest tree species. Simply put, trees grow taller on good sites; grow shorter on poor sites. Therefore, tree height is a more reliable measure of the site's inherent productivity than most other measures. It is also a quick and easy measurement to take in the field, unlike parameters such as soil fertility or microclimate.



## 6.2 Overview of Site Index

To determine site quality using tree height as the indicator, appropriate “site trees” of each species are selected in a stand. The site trees’ heights and ages are measured in the field, and then plotted or *indexed* on species-specific growth curves or tables (see Figure 6.3). These tree height-to-age relationship curves are derived from historical growth and yield field data, and show how the best trees from a variety of sites have grown over time without intensive management or site quality intervention. For a given species, a tree that is 120 feet tall at age 50 typically has better growing conditions than a tree that is only 80 feet tall at age 50. And, as indicated by the growth curves, the shorter tree will most likely continue to grow at a slower rate as it ages (Figure 6.3). There are exceptions to these generalized trends of course, but for most sites the general trends are sufficiently reliable.

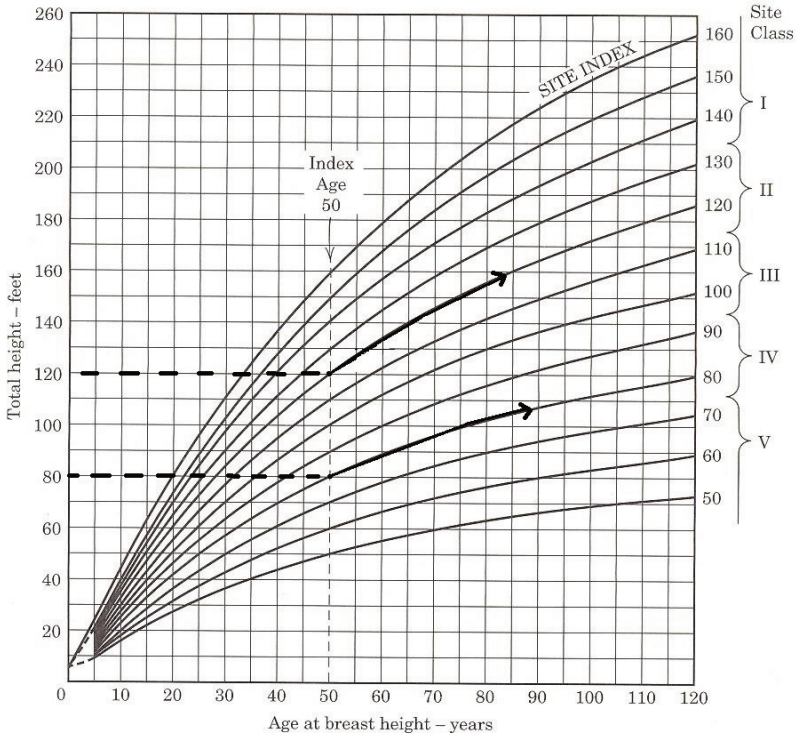

Figure 6.3. Kings' site index for Douglas-fir in western Washington. For a given age a tree 120' tall will continue to grow at a faster rate than a tree 80' tall. (From Smith et al. 1997.)

Site indexes for some species are grouped together into *site classes*, with Site Class I being the highest site, and Site Class V or VI being the lowest. In our first example above for Douglas-fir, the tree whose 50-year site index is 80 feet is in Site Class IV, while the 120 foot tree is growing on Site Class II ground (Figure 6.3).

Trees growing on Site Class I lands are highly productive, typically growing on rich soil, with access to moisture, and protection from the wind. Alluvial sites at low elevations often fall into this category.

Conversely, Site Class V trees are generally growing on poor soils, in droughty climates, or at the upper edge of their elevational range.

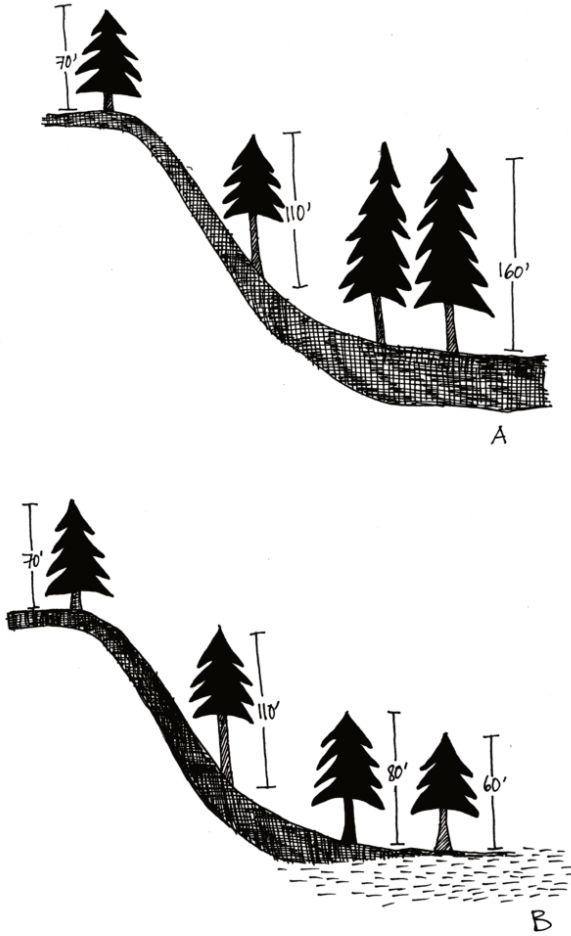

Figure 6.4. Height of dominant trees of the same age on different slope positions. (A) Dark coloring shows depth of soil. (B) Dashed lines indicate water table. (After Spurr and Barnes 1980).

Site Class may also vary on a single slope. The ridgetop, exposed to wind and erosion, may produce trees that fall into Site Class III, whereas the toe of the slope, with less exposed rock and deeper soils collecting that eroded material, is Site Class II (Figure 6.4: A). Further, trees growing midslope with good drainage and plenty of sun may grow taller than the same species at the base of the slope in a riparian area if rooting depth is restricted by a high water table (Figure 6.4: B).

## 6.4 Characteristics of Suitable Site Index Trees

“Site trees” are used to assess a site’s inherent ability to grow trees, and therefore should be the best trees on the site. We select trees expressing the full potential of the site, not those that have been subjected to damage, injury or disease. A tree with a broken top obviously is not as tall as it would have been without the breakage on any given site, and using such a tree would falsely indicate a lower site index than the site is capable of producing. Therefore, in selecting which trees to measure for obtaining site index, care must be taken to avoid those trees that misrepresent the true quality of a site. A site tree must meet *all three* of the following criteria:

1. It must be in the **Dominant or Codominant** crown class.
2. It must be **free from past disturbance, injury or damage**. A site index tree cannot have broken tops, scarred trunks, damaged or compacted root systems, insect injury and so on. These occurrences reduce a tree’s health and vigor so that it does not express the site’s full potential for growth.
3. It must be **free from past suppression**. Some trees can tolerate heavy shade when they are young, and then put on rapid growth

when the canopy opens up, allowing full sunlight to shine on them. This pattern is not acceptable for a site index tree, since light availability dominated the tree's ability to grow. The tree was not expressing the site's full potential when shaded.

Dominant and codominant trees should be examined carefully for outward signs of injury or defect before measuring for site index. In addition, each increment core sample used to estimate age should be checked for evidence of past suppression or injury. Dramatic shifts in the ring sizes, presence of rot, charcoal, and other abnormalities can indicate previous impacts (Figure 6.6).

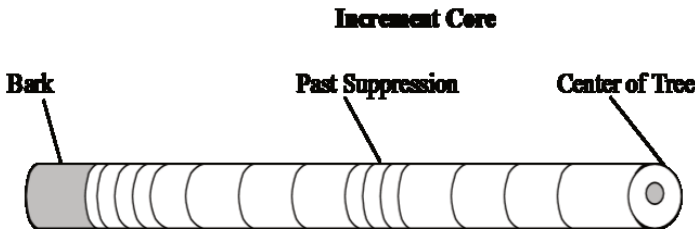

Figure 6.6. An increment core sample showing evidence of past suppression. "Normal" growth rings display a gradual decrease in ring width from pith to bark, as the wood is laid down over a larger and larger diameter. Small widths followed by large ring widths indicate a sudden shift in growing conditions.

The following are illustrations of trees **not suitable** for site index determination, due to defect, injury or past suppression (Figure 6.7).



Figure 6.7 Trees with abnormal growth or injuries do not reflect the full potential for growth on the site. From left: a tree with conks indicating internal rot; a tree with a deformed top indicating damage; a forked tree; a tree with a trunk scar indicating damage.

## 6.5 Field Technique Tips for Determining Site Index

In determining site index, we integrate the technician's abilities to identify crown classes, measure tree height and estimate tree age. This is one of the few cases in which we choose a biased sample of trees to measure. We want to see how trees that were relatively unimpeded by neighboring trees or disturbances can grow on this site. We are trying to use the trees as an indication of the site. The objective is very different than a typical sampling scheme to get an average measure of stand volume, size or growth rates. Therefore, the sampling method is different as well.

1. Select trees to measure. The number of trees to measure will depend upon how variable the stand is, and the degree of accuracy desired. The greater the variability in size and species on the site, the larger the sample size needed to get an accurate estimate of site quality for each species present. For species that are grouped into Site Classes, a relative ranking is the objective, so a large sample size is not required.



**Criteria for selection:**

- *Dominant or codominant crown class.* Choose trees whose crowns are receiving full sunlight.
  - Check the outside—*Free from past disturbance.* Check *all sides* of the tree for signs of insect galls, conks, witches brooms, basal or trunk scars, breakage, etc. Check around the base of the tree for signs of root disease (e.g. *Phaellus* spp. or *Heterobasidium* spp.). There may be instances in which a stand severely hit by an ice or windstorm will have very few suitable site index trees to choose from.
  - Check the inside—*Free from past suppression.* This may be difficult to assess on larger trees without looking at the increment core sample. Some people will core the tree first to make sure it is a usable site index tree before measuring the height to save time. On smaller trees, the distance between whorls can indicate general growth rate trends.
2. Extract a clean, intact core sample to estimate age.
- Check core for evidence of rot, charcoal, past suppression or drought.
  - Make sure you can read the age – use a magnifying glass or hand lens on trees with tight rings. Look carefully at the regions indicating the center of the tree. Core samples more than a few of years from the pith are not reliable. Count the rings twice.
3. Measure total height. Obviously, this is a critical measurement. *Measure* your distance from the tree – do not pace. Make sure you can *see* the top. From a perspective that allows a clear view of the crown, look for evidence of breakage – flat tops, longer than

expected side branches, etc. Also look for sucker limbs and forking in the crown.

4. Record your measurements. Record each tree as a pair of measurements – height and age. The two measurements are used together to obtain site index, so *keep them as a pair*. Always record breast height age in the field. This number can later be adjusted to total age by adding the number of years commonly needed for that species to reach breast height. This will vary by species and region. Typically, it is 4–8 years for most low elevation conifers.

## 6.6. Determining Site Index from Field Measurements

Once height and age measurements are obtained for all site trees, site index can be determined.

1. Produce height and age measurements for suitable site index trees following the protocol from Section 6.5. Data for two Douglas-fir trees are listed below in Table 6.1.

Tree	Total Tree Height (ft.)	Breast Ht. Age* (yrs.)	Site Index (ft.)
A	114	45	123
B	135	68	113

\* King's site index uses breast height age (from a core sample taken at dbh).

2. Plot each tree on the site index graph using the height and age as measured in the field.
3. Follow the curves forward or backward to the base age (50 years). In this case, we will “grow” Tree A to age 50, following the trends indicated by the nearest curves as we do so (Figure 6.6).

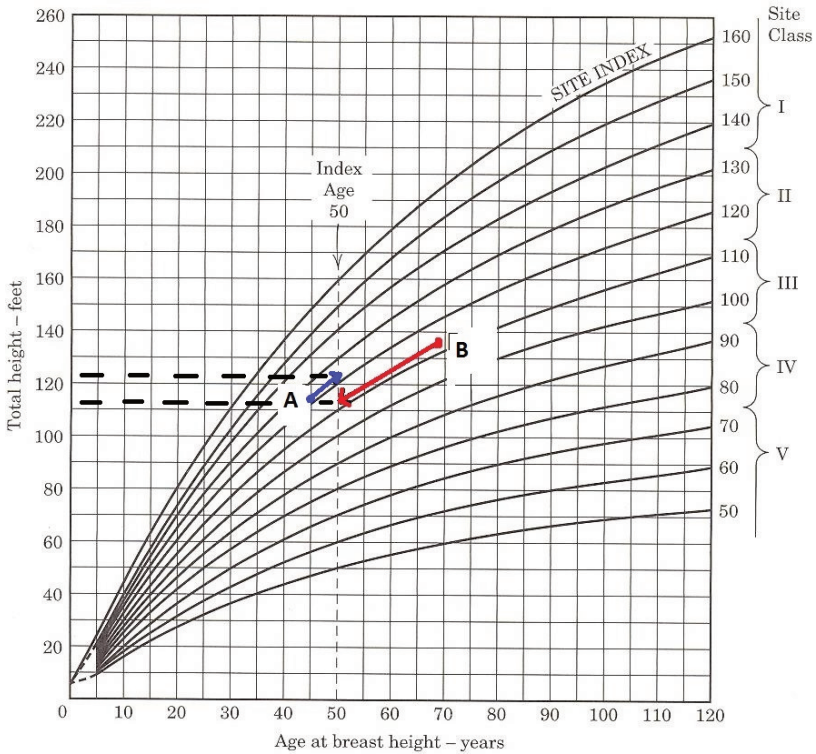

Figure 6.6. Tree A is “grown” from 45 years to 50 years. Estimated height at 50 years is  $\approx 123'$ . Site Index for Tree A is 123. Tree B is traced back to 50 years. Estimated height at 50 years is  $\approx 113'$ . Site Index for Tree B is 113. Thus two trees of unequal age can be compared on a relative basis to indicate how capable the forest site is of growing Douglas-fir trees. (Adapted from Smith et al. 1997.)

4. Determine the height of Tree A at age 50. This height, 123 feet, is the *Site Index* for that tree.

5. **Repeat this for each site tree.** When a site index value for each tree has been determined, an average can be calculated for the stand. The average for our two trees is 118 feet, which puts our trees on low site Class II land. It is *not correct* to calculate the average age and average height of the measured trees, and plot that to determine site index.



## 6.3 How to Use Site Index Curves

Site Index is defined as the *height* of a tree at some base age. Height is in feet. For young stands, a base age of 50 years is typically used; for mature stands a base age of 100 is used. As rotation lengths decline, more and more site index values are indexed to a base age of 50. In the literature of Pacific Northwest species, if the age is not referenced, a base age of 100 years is understood. In practice, most second-growth stands are indexed to age 50. For some short-lived species, such as red alder (*Alnus rubra*), a base age of 20 years may be used.

Therefore, a stand with an average 50-yr site index of 110 would indicate that the trees are capable of reaching a total height of 110 feet at 50 years. By establishing a base age, stands of any age can be evaluated and compared, and thus the number “110” becomes an index to the site’s productivity. We know whether this is a high site or low site when compared with other tree heights at this age.

Site index curves have been developed by plotting heights of different aged trees from study areas throughout a region. Best-fit lines are drawn through the plotted trees, and harmonic curves developed. The curves for King’s 50-yr site index for Douglas-fir, developed from stem analysis of trees in western Washington, are shown in Figure 6.5. Note that as site quality improves, the curves are

steeper, particularly for young trees. Growth rates tend to level out as the trees mature.

The growth curves also allow one to estimate a tree's height at any age. By tracing along the curves, a tree that is 40 years old can be "grown" to obtain its estimated height at age 50 or 100 years. Likewise, a curve can estimate how tall a 90 year-old tree was at age 50 (see Figure 6.5). In this way, the growth curves can use current height and age data to predict the height of trees at a common or *index* age. **Site index (SI)**, defined as the height of dominant and codominant trees at a base age (usually 50 or 100 years), puts trees of all ages on a relative basis so that the index number has meaning and comparisons can be made. The lower the index number, regardless of the tree's current age, the poorer the site; the higher the index number, the better the site.

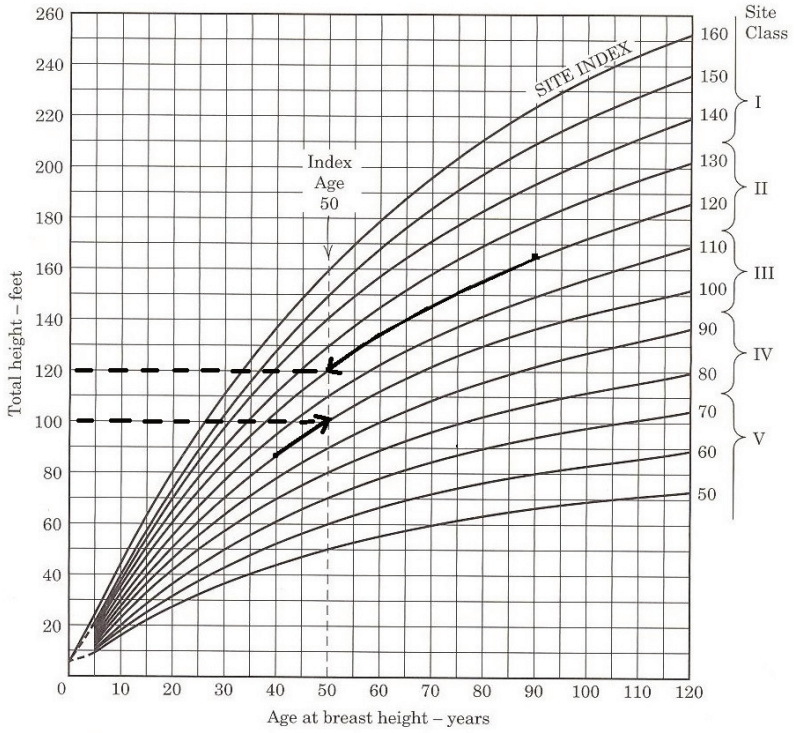

Figure 6.5. Tracing height growth backward (top line) or forward (bottom line) to reach age 50. (From Smith et al. 1997.)



# Glossary

Definitions presented are from *The Dictionary of Forestry* (Helms 1998) and *Forest Measurements* (Avery and Burkhart 2002) where possible. Remaining definitions are from other sources.

**annual ring** – *see* **growth ring**

**broken top** A tree whose uppermost whorls of branches and main stem have broken off the main trunk. – *note*: a flattened top appears, and commonly rot is introduced to the main stem

**butt swell** Flare of the main stem at the base of a tree providing mechanical support to keep the tree upright

**caliper(s)** An instrument for determining tree and log diameters by measuring their rectangular projection on a *straight*, graduated rule via two arms at right angles to (and one of them sliding along) the rule itself

**canopy** The foliar cover in a forest stand (may consist of one or several layers); generally refers to the top or overstory layer

**clinometer** An instrument for measuring angles of elevation or depression

**codominant** – *see* **crown class**

**competition** The extent to which each organism maximizes fitness by both appropriating contested resources from a pool not

sufficient for all, and adapting to the environment altered by all participants – *note*: competition among individuals of the same species is termed *intraspecific* competition; competition between different species is termed *interspecific* competition

**crown** The part of a tree or woody plant bearing live branches and foliage

**crown class** A category of tree based on its crown position relative to those of adjacent trees

**codominant** – a tree whose crown helps to form the general level of the main canopy in even-aged stands, or in uneven-aged stands, the main canopy of the tree's immediate neighbors, receiving full light from above and comparatively little from the sides

**dominant** – a tree whose crown extends above the general level of the main canopy in even-aged stands, or in uneven-aged stands, above the crowns of a tree's immediate neighbors and receiving full light from above and partial light from the sides

**intermediate** – a tree whose crown extends into the lower portion of the main canopy in even-aged stands, or in uneven-aged stands, into the lower portion of the canopy formed by the tree's immediate neighbors, but shorter in height than the codominants, and receiving little direct light from above and none from the sides

**suppressed or overtopped** – a tree whose crown is completely overtopped by one or more neighboring trees

**cruise intensity** The percentage of a population that is sampled

**dendrochronology** The study and interpretation of annual growth rings of trees and their use in dating past variations in climate and in archaeological investigations

**density** The size of a population in relation to some unit of space

– *note*: density is usually expressed as the number of individuals or the population biomass per unit area or volume

**determinate height growth** (determinate growth) Growth whose structures are initiated by a **meristem** in one year but do not complete development until the meristem resumes growth in the following year

**diameter at breast height** (DBH) The diameter of the stem of a tree measured at breast height 4.5 ft or 1.37 m from the ground – *note*: on sloping ground the measure is taken from the uphill side

**diameter class** Any of the intervals into which a range of diameters of tree stems or logs may be divided for classification and use – e.g., the 6 inch diameter class includes diameters from 5.0 to 6.9 inches

**diameter tape** A tape measure specially graduated so that the diameter can be read directly from the circumference of a tree stem or log

**disturbance** Any relatively discrete event in time that disrupts ecosystem, community, or population structure and changes resources, substrate availability, or the physical environment

**dominant** – *see crown class*

**evenaged (stand)** A stand of trees composed of trees of the same, or approximately the same age

**forest** An ecosystem characterized by tree cover

**forked tree** A tree whose main stem splits into two or more main stems

**global positioning system (GPS)** A satellite-based positioning system that gives a user's position anywhere on earth

**growth ring** The cumulative layers of cells produced during a single growing season, and characteristically containing earlywood and latewood cells of differing morphology

**hypsoneter** Any instrument based on geometric or trigonometric principles for measuring the heights of standing trees

**increment borer** An auger-like instrument with a hollow bit and an extractor used to extract thin radial cylinders of wood (increment cores) from trees having annual growth rings, to determine increment or age

**intermediate** – *see* **crown class**

**live crown ratio** The ratio of the length of live crown to total tree height

**merchantable (tree) height** The commercial height above ground or (in some countries) above stump height

**multistoried stand** The cultivation of a large variety of mostly multipurpose plants in various vegetation layers to maximize the use of environmental factors such as water, nutrients, and sunlight

**old-growth (forest)** The late successional stage of forest development – *note 1*: old-growth forests are defined in many ways; generally, structural characteristics used to describe old-growth forests include (a) live trees: number and minimum size, (b) canopy conditions: commonly including multilayering, (c) snags: minimum number of specific size, and (d) down logs and coarse woody debris: minimum tonnage and numbers of pieces of specific size – *note 2*: stand age, although a useful indicator of old growth, is often considered less important than structure because (a) the rate of stand development depends more on environment and stand history than age alone, and (b) dominants are often multiaged – *note 3*: due to large differences in forest types, climate, site quality, and natural disturbance history (e.g., fire, wind, and disease and insect epidemics), old-growth forests vary extensively in tree size, age classes, presence and abundance of structural elements, stability, and presence of understory

- old-growth stage** A temporal stage of forest development typified by old-growth stand structure – *see* **old-growth**
- open shrub stage** A temporal stage of forest stand development immediately following disturbance characterized by low or no tree cover and dominated by understory plants
- overstory** that portion of trees forming the uppermost canopy layer
- overtopped** – *see* **crown class**
- percent slope** A slope ratio with rise expressed as a % of the run. –*see* **slope**
- pith** The central core of a stem, branches, and some roots representing the first year of growth, and consisting mainly of soft tissue
- profiles** A side view of a hillslope, illustrating the changes in surface gradient
- rise** The vertical distance between two points
- run** The horizontal distance between two points
- shade tolerance (tolerant)** Having the capacity to compete for survival under shaded conditions
- site class** A classification of site quality, usually expressed in terms of ranges of dominant tree height at a given age
- site index** A species-specific measure of actual or potential forest productivity (usually for even-aged stands), expressed as the average height of dominant, codominant trees at a specified index or base age
- site quality** The productive capacity of a site, usually expressed as volume production of a given species –*synonym* **site productivity**
- site tree** A tree used to determine site index – *note*: site trees must meet defined criteria
- slope** A measure of change in surface value over distance, expressed

in degrees or as a percentage – e.g., a rise of 2 m over a distance of 100 m (or 2 ft over 100 ft) describes a 2 percent slope

**slope distance** The extent of space between two points on a sloped surface

**stand** A contiguous group of trees sufficiently uniform in age-class distribution, composition, and structure, and growing on a site of sufficiently uniform quality, to be a distinguishable unit

**stand density** A quantitative measure of stem crowding within a stocked area

**stand structure** The horizontal and vertical distribution of components of a forest stand including the height, diameter, crown layers, and stems of trees, shrubs, herbaceous understory, snags, and down woody debris

**stand table** A tabulation of the total number of stems per acre by dbh and species

**stem** 1. The principal axis of a plant from which buds and shoots develop 2. The trunk or main stem of a tree

**stem exclusion stage** A temporal stage of forest stand development following crown closure

**succession** The gradual supplanting of one community of plants by another. – *note*: the sequence of communities is called a **sere**, or seral stage

**suppressed** –*see* **crown class, overtopped**

**suppression** The process whereby a tree or other vegetation loses vigor and may die when growing space is not sufficient to provide photosynthate or moisture to support adequate growth

**topographic slope** A ratio of rise over run expressed as a one unit of change in elevation for every 66 units of change in horizontal distance – *see* **slope**

**total (tree) height** Height of the main stem of a tree from a one-foot stump (generally) to the very tip of its leader

**understory** All forest vegetation growing under an overstory

**understory reinitiation stage** A temporal stage of forest development characterized by gaps in the forest overstory caused by suppression and introduction of new seedlings in the forest understory

**uneven-aged (stand)** A stand with trees of three or more distinct age classes, either intimately mixed or in small groups

**whorl** A circle of leaves, flowers, branches, or other organs developed from one node