



Building Maintenance & Construction: Tools and Maintenance Tasks (Interactive)

Building Maintenance &
Construction: Tools and
Maintenance Tasks
(Interactive)

CLIFFORD RUTHERFORD



Building Maintenance & Construction: Tools and Maintenance Tasks (Interactive) by University of Hawai'i Maui College and the Construction Technology Program is licensed under a Creative Commons Attribution 4.0 International License, except where otherwise noted.

Contents

Introduction	1
<i>Learning Outcomes</i>	1
<i>Prerequisites</i>	2
<i>Disclaimer</i>	2
<i>Professional Licensing</i>	3
<i>About the Author</i>	3
	3
<i>Dedication</i>	5
<i>Contact the Author</i>	5
<i>Acknowledgements</i>	vii
<i>Edited and Reviewed By</i>	viii
<i>Front Cover Photo</i>	ix
<i>Special Thanks to</i>	ix
<i>Open Educational Resources</i>	ix
Part I: Safety	
1.1 First Aid & Personal Protective Equipment	13
<i>First Things First</i>	13
<i>First Aid Kit</i>	14

1.2 Eye and Face Protection	15
<i>Eye & Face Protection</i>	15
1.3 Hearing Protection	18
<i>Hearing Protection</i>	18
1.4 Head Protection	24
<i>Head Protection</i>	24
1.5 Hand Protection	29
<i>Hand Protection</i>	29
1.6 Respiratory Protection	37
<i>Respiratory Protection</i>	37
1.7 Foot Protection	47
<i>Footwear</i>	47
1.8 Tool & Shop Safety	51
<i>Hand Tool Safety</i>	52
<i>Power Tool Safety</i>	53
1.9 Ladder Safety & Fall Protection	56
<i>Ladder Safety</i>	57
<i>Safety Harness</i>	63
Part 2: Hand & Power Tools	
2.1 Tool Choices and Applications	67
2.2 Measuring, Marking, Leveling & Layout Tools	71
<i>Measuring, Marking, Leveling & Layout Tools</i>	71

2.3 Nails, Hammers & Pneumatic Nailers	74
Nails	74
<i>Common Nails for Building & Construction Projects</i>	75
Hammers	76
<i>General Hammer Use</i>	76
Nail Gun Safety	77
<i>Introduction to Nail Gun Safety</i>	80
<i>Know Your Triggers</i>	82
<i>How do Nail Gun Injuries Happen?</i>	83
<i>Six Steps to Nail Gun Safety</i>	89
DO's	92
Don'ts	94
<i>Other Hazards</i>	97
<i>Conclusion</i>	99
2.4 Threaded Fasteners, Drivers, Pliers & Wrenches	100
<i>Threaded Fasteners</i>	100
<i>Drivers</i>	103
<i>Pliers</i>	104
<i>Wrenches</i>	104

2.5 Saws	106
<i>Choices</i>	106
<i>Saw Blades</i>	107
<i>Additional Basic Saw Terminology</i>	107
<i>Saw Safety</i>	108
<i>Saw Types and Applications</i>	109
<i>Other Saws</i>	117
2.6 Drills & Accessories	122
<i>Drills</i>	122
2.7 Grinders, Sanders, & Accessories	126
<i>Grinders</i>	126
<i>Sanders</i>	128
<i>Sand Paper</i>	129
<i>Styles</i>	130
	131
Part 3: Mathematics for Maintenance Techs	
3.1 Required Math Concepts	135
<i>Numeral System and Notation</i>	135
<i>Perimeter, Area, and Volume</i>	160
<i>Conversion of US Liquid Measures to Metric System</i>	179
<i>Conversion of US Linear Measures to Metric System</i>	181
3.2 Ohm's Law, Joules Law, and Series/Parallel Formulas	182

Part 4: Plumbing Systems

4.1 Piping & Fittings	197
<i>Pipes</i>	197
<i>Fittings</i>	198
<i>Solvent Cleaners, Primers, & Cements or Glues</i>	215
<i>Threaded Pipe Fitting Assembly</i>	219
<i>Copper Pipe Fitting and Soldering</i>	222
4.2 Domestic Water Service	224
<i>Potable Water</i>	224
<i>Specialty Tools</i>	224
<i>Water Meters</i>	225
	226
<i>Residential Piping</i>	227

4.3 Drain, Waste, and Vent (DWV)	230
<i>DWV Terminology</i>	230
<i>Building Sewer</i>	230
<i>Clean-Outs</i>	230
	232
<i>Building Drain</i>	232
<i>Waste Stack</i>	233
<i>Stack Vent</i>	233
<i>Vent Stack</i>	233
<i>Fixture Drain</i>	234
<i>Fixture Branch</i>	234
<i>Horizontal Branch</i>	234
<i>Individual Vent</i>	234
<i>Branch Vent</i>	235
<i>Circuit Vent</i>	235
<i>Loop Vent</i>	235
<i>Relief Vent</i>	236
<i>Trap</i>	236
<i>Trap Adapter</i>	237
<i>Drain Cleaning</i>	238

4.4 Valves & Prevention Devices	240
Isolation Valves	240
Types of Isolation Valves & Residential Uses	241
Hose End Outlets	246
Types of Hose End Outlets	247
Protective Valves and Devices	248
Protective Valves and Devices and Their Uses	249
4.5 Faucets, Fixtures, & Fixture Drains	257
Faucets	258
Faucet Installation	259
Drain Assemblies	260
Fixture Types and Assemblies	261
Toilet	261
Lavatory sink	263
Bathtub	265
Shower	267
Kitchen sink	269
Laundry Sink	271
Bidet	272
4.6 Plumbing for Appliances	274
Dishwashers	274
Garbage Disposers	275
Washing Machine Boxes	277
Icemaker Boxes	278

4.7 Water Heating	279
<i>Conventional Water Heating Systems</i>	279
<i>Electric Water Heaters</i>	280
<i>Electric Water Heater Components and Their Functions</i>	281
<i>Gas Regulators</i>	286
<i>Tankless Water Heaters</i>	287
<i>Solar Water Heaters</i>	288
<i>Diagnosing Common Water Heater Problems</i>	288
<i>Electric Water Heater Diagnostics</i>	289
<i>Gas Water Heater Diagnostics</i>	292
Part 5: Electrical Systems	
5.1 Electrical Safety	301
<i>Electrical Safety Considerations</i>	301
<i>Electrical Shock</i>	301
<i>Arc Flash and Arc Blast</i>	303
<i>Lockout-Tagout</i>	305
<i>Electrical Systems and Testing Terminology</i>	306
<i>General Safety Rules for Electrical Maintenance Technicians</i>	307
<i>Non-Energized Testing</i>	308
<i>Insulated Tools</i>	308

5.2 Electrical Tools & Testing Equipment	310
<i>Electrical Tools</i>	310
<i>Electrical Meters and Testers</i>	310
<i>Meter Safety</i>	311
<i>Meter Care</i>	312
5.3 Electrical Terminology & Lighting	313
<i>Terminology</i>	313
<i>Lighting</i>	314
5.4 Conduit, Boxes, & Wiring	317
<i>Conduit</i>	317
<i>Raceways used in residential wiring include:</i>	318
<i>EMT Conduit Bending</i>	318
<i>Boxes</i>	321
<i>Metal Boxes</i>	322
<i>Nonmetallic Device Boxes</i>	322
<i>PVC Conduit Boxes</i>	323
<i>Wires (Conductors)</i>	323
	324
<i>Wire Color and Use</i>	325
<i>Conductor Installation</i>	326
<i>Terminations</i>	327
<i>Cable Types</i>	328

5.5 Fuses & Breakers	334
<i>Panelboards and Loadcenters</i>	334
<i>Fuses</i>	338
<i>Circuit Breakers</i>	340
<i>Common Branch Circuits</i>	343
<i>Circuit Breaker Replacement</i>	344
5.6 Receptacle & Switch Wiring	346
<i>Receptacles</i>	346
<i>Common House Wiring Receptacles</i>	347
<i>125 Volt Receptacles</i>	347
<i>250 Volt Receptacles</i>	350
<i>Receptacle Installation</i>	352
<i>Specialty Receptacle Types</i>	357
<i>125/250 Volt Electric Clothes Dryer</i>	358
<i>125/250 Volt Electric Range</i>	361
<i>Switches</i>	363
<i>Combination Devices</i>	369
5.7 Outdoor Wiring Considerations	370
<i>Wiring for Outdoors</i>	370
<i>Outdoor Receptacles</i>	371
<i>Outdoor Lighting</i>	373
Part 6: Maintenance Management Systems	
6.1 Maintenance Categories	377

6.2 Work Order Process	379
<i>Commercial Maintenance Process</i>	379
<i>Service Request</i>	379
<i>Service Call Procedures</i>	380
6.3 Parts and Material Resources	381
<i>Manufacture and Vendor Parts and Repair Resources</i>	381
<i>Part Types</i>	382
<i>Procurement</i>	382
<i>Ordering Parts & Materials</i>	383
<i>Quantities</i>	385
<i>Weights & Measures</i>	385
<i>Standardized Measurement</i>	386

Introduction

Building Maintenance & Construction: Tools and Maintenance Tasks introduces and develops knowledge of basic building maintenance tools and materials, applied skills and techniques, industry health and safety standards, and preventive maintenance and troubleshooting practices required by employers for entry-level positions in the building trades and facilities maintenance fields.

Learning Outcomes

Participants that successfully complete this text should be able to:

1. Describe and demonstrate safe use of common hand and power tools used to perform common maintenance and construction tasks.
2. Identify and perform basic preventive and reactive maintenance procedures for residential homes, apartments, and appliances.
3. Identify standard building and construction materials, basic building mechanical systems and components, and discuss applicable solutions to mitigate building envelope and basic mechanical system component failures.
4. Describe procedures for research, requisition, and procurement of materials and parts to complete construction and maintenance tasks and/or work orders.
5. Apply quantitative methods to common building maintenance tasks.

Prerequisites

Procedures discussed throughout the Building Maintenance & Construction text require application of basic mathematics and physical science. Readers will be introduced to general mathematical formulas, critical thinking skills, and safety as applied to specific tools and tasks throughout the book.

Disclaimer

This text is designed to provide accurate authoritative information with regard to the subject matter covered. The University of Hawai'i and the author/s specifically disclaim any liability, loss or risk, personal or otherwise, incurred as a consequence directly or indirectly from the use and application of any of the techniques, strategies, or contents of this text.

All content found herein is believed to be in the “public domain” or is the original work of the author based upon experience and is intended to be used for educational purposes. Some of the images displayed may be of unknown origin. The author/s and publishers have no intent to infringe any legitimate intellectual right, artistic rights or copyright. Citation of sources, when known, are provided throughout the text. The author/s and the University of Hawai'i intend no gain or financial benefit from the downloads of any pictures, images, or video.

If you are the rightful owner of any of the pictures/images within, and you do not want it to be displayed or if you require a suitable credit, then please contact us at crutherf@hawaii.edu and we will immediately do whatever is needed, either for the image to be removed or provide credit where it is due.

Professional Licensing

Professional journey license and/or apprenticeship under the guidance of a licensed electrician, plumber, or other licensed trades person are required to perform many of the tasks and skills demonstrated in this text in most states. *By all means, text end users are not certified as technicians or journeymen (women) to perform these tasks on their own.*

About the Author

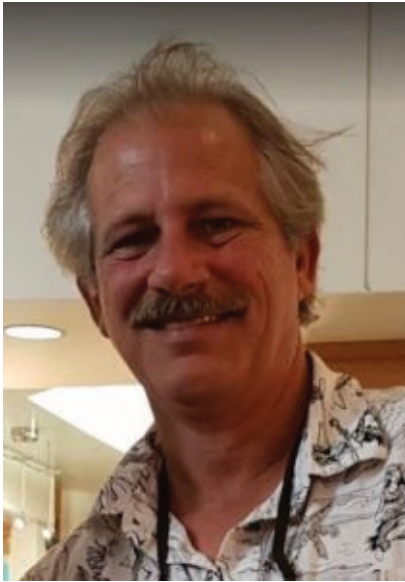

Clifford "Cliff" Rutherford has 35+ years of journey-level residential

and commercial construction, mechanical trades and facilities engineering experience. Prior to 2006, Cliff's mechanical and construction experience was gained working in Texas as a machinist, HVACR installation and repair technician, hydraulic/pneumatic equipment mechanic/operator/trainer, apartment and resort facilities head engineer, and private builder/contractor specializing in design-build projects for commercial applications. Moving to Hawai'i in 2006, Cliff worked for a Maui home builder and mechanical contractor specializing in residential construction, commercial plumbing and mechanical trades.

In January 2009, Cliff started teaching carpentry, blueprint reading, and computer aided drafting (CAD) classes for the University of Hawai'i Maui College's high-school based dual credit enrollment Construction Academy Program at Lahainaluna and Hāna high schools on the island of Maui, and Lāna'i High School on the Island of Lāna'i, later coordinating the program encompassing all seven Department of Education high schools in the program. Since 2014, Cliff has continued his work with UH Maui College as Program Coordinator for the Construction Technology Program, developing and adopting curriculum for the program's multiple trades AAS degree credit courses in CAD, blueprint reading and drafting, carpentry, electrical, plumbing, masonry, energy and sustainability, small engine repair, HVACR, painting and decorating, welding and occupational safety.

Cliff has earned and maintains several industry credentials. These include but are not limited to: Career and Technical Education (CTE) teaching certificates; National Association of Homebuilders (NAHB) Residential Construction certification for instructors, Certified Green Professional (CGP), and Certified Aging-in-Place Specialist (CAPS) designations; International Facility Management Association's (IFMAs) Sustainable Facility Professional (SFP) designation; Northwest Energy Efficiency Council's Building Operator Certificate (BOC) 1 & 2 Instructor certification; National Renewable Energy

Laboratory (NREL) Solar Thermal Water Train-the-Trainer and ESCO EPA-608 Instructor/Proctor.

As strong believer in providing up-to-date and relevant continued education opportunities for the local community, Cliff has developed and taught several maintenance and construction skills based courses for local employers and community members as non-credit offerings through the Office of Continuing Education and Workforce Development programs at Maui College. He also teaches industry recognized professional development and certification courses that include courses for the Environmental Protection Agency (EPA) 608 Universal Technician Certification, Northwest Energy Efficiency Council's Building Operator Certificate (BOC) 1 & 2, and IFMA's SFP designation.

Dedication

This book is dedicated to my students, mentors, and colleagues, past, present, and future, who challenge me each day to be a passionate and compassionate teacher, peer, and friend.

And most of all, to my wife and best friend, Rosemary, who always encourages me to do the impossible, believes I can achieve more than I myself believe, and has sacrificed so much for me to prove I can.

~Cliff

Contact the Author

Clifford Rutherford
University of Hawai'i Maui College

310 West Ka`ahumanu Ave
Kahului, HI 96732
crutherf@hawaii.edu

Acknowledgements

Chapters and sections were borrowed and adapted from the following existing OER textbooks on Math and government bodies. Mahalo (thank you) to those who shared before us:

OpenStax Prealgebra // CC BY 4.0

- Chapter 4 Fractions
- Chapter 5 Decimals
- Chapter 9 Math Models and Geometry
- Chapter 10 Polynomials

OpenStax Elementary Algebra // CC BY 4.0

- Chapter 1 Foundations
- Chapter 9 Roots and Radicals

OpenStax College Algebra // CC BY 4.0

- Chapter 1 Prerequisites

OpenStax College Physics for AP Courses // CC BY 4.0

- Chapter 20 Electric Current, Resistance, and Ohm's Law
- Chapter 21 Circuits, Bioelectricity, and DC Instruments

United States Department of Labor – Occupational Safety and Health Administration (OSHA)

All other content should include the following attribution statement:

–

Except where otherwise noted materials in this Building Maintenance & Construction eBook are licensed Creative Commons Attribution 4.0 (CC BY) by the University of Hawai'i Maui College and the Construction Technology Program. Download this book for free at: <http://pressbooks.oer.hawaii.edu/buildingmaintenance/>

–

Edited and Reviewed By

Jonathan Kevan – University of Hawai'i at Mānoa

Hong Ngo – University of Hawai'i at Mānoa

Phil Johnson – Architectural Project Manager, Maui, Hawai'i

- *“The book is a wealth of information. It is very clearly and logically presented.”*
- *“While basic knowledge level differs from trade to trade, I believe that if a student mastered information presented in this book, they would be several steps above “entry Level”.”*
- *“Even beginning trade apprentices may find some of the areas challenging.”*
- *“This Book would be a good resource and reference for teaching introductory trade course.”*

Rick Rutiz – Executive Director, Ma Ka Hana Ka 'Ike Building Program

“Cliff is a repository of building and construction techniques, skills, and information, all of which is found in this book. But the real strength of his teaching ability is the rapport he creates with his students. As the director of the vocational training program Ma Ka Hana Ka 'Ike, I've had the privilege of watching Cliff bring construction theory to

life – not just with great expertise, but with heart. Now he’s put this knowledge in book form to share with all of you.”

Front Cover Photo

University of Hawai’i Maui College – Construction Technology Program / CC BY 4.0

Special Thanks to

Funding provided by the United States Department of Labor Employment and Training Administration under the TAACCCT grant that supported the development of this OER eBook.

Open Educational Resources

This text is provided to you as an Open Educational Resource (OER) which you access online. It is designed to give you a comprehensive introduction to building maintenance and construction at no or very nominal cost. It contains both written and graphic text material, intra-text links to other internal material which may aid in understanding topics and concepts, tables and definitions of words, and extra-text links to videos and web material that clarifies and augments topics and concepts.

PART I: SAFETY

I.I First Aid & Personal Protective Equipment

First Things First

Job site accidents and injuries as a result of tools and equipment being misused or failing are quite common. Cuts and punctures from sharp objects, contusions from blunt objects or impacts, burns from open flame torches and hot pipes, splashing of chemicals or debris to the eyes, and electrical shock are just a few of the common injuries associated with the building maintenance trade.

As construction and maintenance processes offer the potential for many types of traumatic and life threatening injuries, workers in skilled trades should be aware of the hazards and be prepared to respond in the event of an injury. While many industry tasks are performed by a single person, often isolated from others, it is recommended that industry workers receive First Aid and Cardiopulmonary Resuscitation (CPR), and Occupational Safety and Health Administration (OSHA) 10 or 30 Hour Training for Construction certificates. Training will enable industry tradespersons to better assess workplace hazards and respond to them appropriately, whether an incident involves yourself, a teammate, or others on the job site. In person, hands-on First Aid/CPR training can be found through local health and welfare organizations, educational institutions (credit or non-credit), and medical providers. OSHA in person courses can be found at local educational institutions (credit or non-credit), and in online formats through various educational institutions and commercial providers.

First Aid Kit

Although we all hope that we never need one, a first aid kit should be kept on the service vehicle or on the job site at all times. Be sure your first aid kit has you prepared for the type of injuries connected to your field of work. The size of the first aid kit should reflect the number of employees kit is intended to service. Most commercial first aid kits are rated by the amount of people or employees to be served.



First Aid Kit by Viole Multerer is licensed under CC BY 4.0

1.2 Eye and Face Protection

Eye & Face Protection

Employees can be exposed to a large number of hazards that pose danger to their eyes and face. OSHA requires employers to ensure that employees have appropriate eye or face protection if they are exposed to eye or face hazards from flying particles, molten metal, liquid chemicals, acids or caustic liquids, chemical gases or vapors, potentially infected material or potentially harmful light radiation.

OSHA suggests that eye protection be routinely considered for use by carpenters, electricians, machinists, mechanics, millwrights, plumbers and pipefitters, sheet metal employees and tinsmiths, assemblers, sanders, grinding machine operators, sawyers, welders, laborers, chemical process operators and handlers, and timber cutting and logging workers. Employers of employees in other job categories should decide whether there is a need for eye and face PPE through a hazard assessment.

Examples of potential eye or face injuries include:

- Dust, dirt, metal or wood chips entering the eye from activities such as chipping, grinding, sawing, hammering, the use of power tools or even strong wind forces.
- Chemical splashes from corrosive substances, hot liquids, solvents or other hazardous solutions.
- Objects swinging into the eye or face, such as tree limbs, chains, tools or ropes.
- Radiant energy from welding, harmful rays from the use of lasers or other radiant light (as well as heat, glare, sparks, splash and flying particles).

Many occupational eye injuries occur because employees are not wearing any eye protection while others result from wearing improper or poorly fitting eye protection. Employers must be sure that their employees wear appropriate eye and face protection and that the selected form of protection is appropriate to the work being performed and properly fits each employee exposed to the hazard.

TYPES OF EYE PROTECTION

Selecting the most suitable eye and face protection for employees should take into consideration the following elements:

- Ability to protect against specific workplace hazards.
- Should fit properly and be reasonably comfortable to wear.
- Should provide unrestricted vision and movement.
- Should be durable and cleanable.
- Should allow unrestricted functioning of any other required PPE.

The eye and face protection selected for employee use must clearly identify the manufacturer. Any new eye and face protective devices must comply with ANSI Z87.1-1989 or be at least as effective as this standard requires. Any equipment purchased before this requirement took effect on July 5, 1994, must comply with the earlier ANSI Standard (ANSI Z87.1-1968) or be shown to be equally effective. See the eye protection selection guide for the most recent standard (ANSI Z87.1-2015).

An employer may choose to provide one pair of protective eyewear for each position rather than individual eyewear for each employee. If this is done, the employer must make sure that employees disinfect shared protective eyewear after each use. Protective eyewear with corrective lenses may only be used by the employee for whom the

corrective prescription was issued and may not be shared among employees.

Some of the most common types of eye and face protection include the following examples:



An interactive or media element has been excluded from this version of the text. You can view it online here:

<http://pressbooks.oer.hawaii.edu/buildingmaint/?p=24>

1.3 Hearing Protection

Hearing Protection

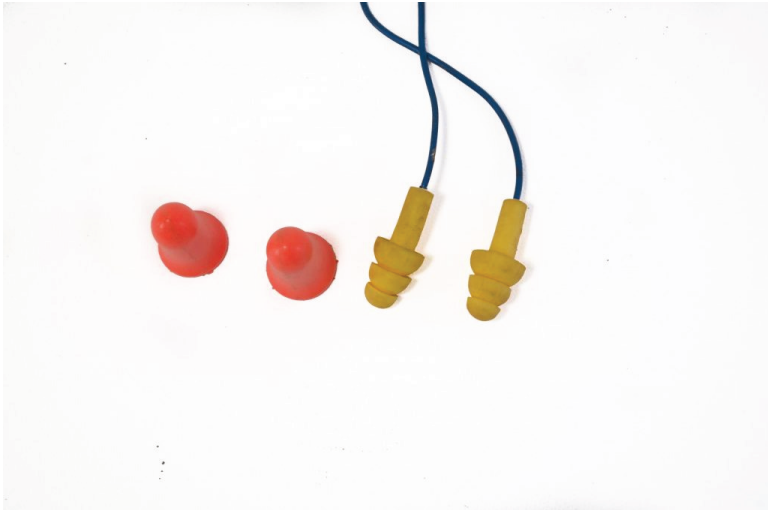

Hearing Protection by Benjamim Souza is licensed under CC BY 4.0

Some types of hearing protection include:

- **Single-use Earplugs** – Single-use earplugs are made of waxed cotton, foam, silicone rubber or fiberglass wool. They are self-forming and, when properly inserted, they work as well as most molded earplugs.
- **Molded Earplugs** – Pre-formed or molded earplugs must be individually fitted by a professional and can be disposable or

reusable. Reusable plugs should be cleaned after each use.

- **Earmuffs** – Require a perfect seal around the ear. Glasses, facial hair, long hair or facial movements such as chewing may reduce the protective value of earmuffs.

Note: Audio headphones and earbuds are not approved devices for hearing protection.

Determining the need to provide hearing protection for employees can be challenging. Employee exposure to excessive noise depends upon a number of factors, including:

- The loudness of the noise as measured in decibels (dB).
- The duration of each employee's exposure to the noise.
- Whether employees move between work areas with different noise levels.
- Whether noise is generated from one or multiple sources.

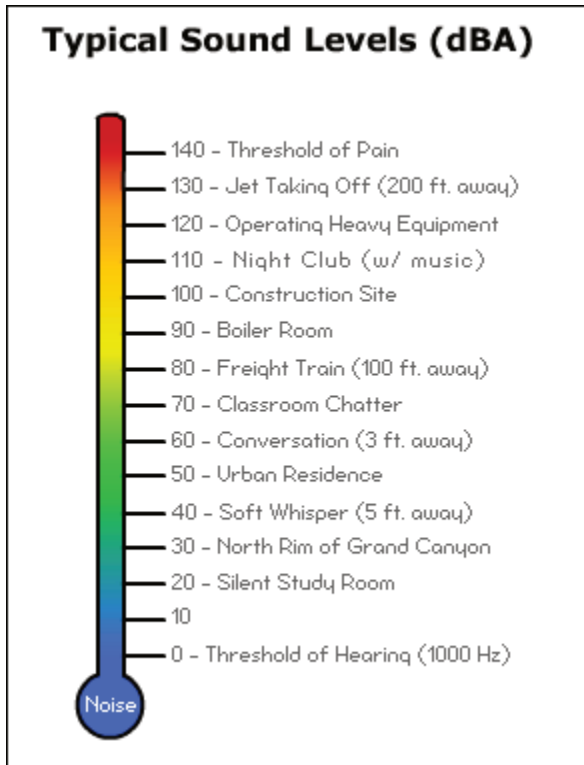

Typical Sound Level by OSHA is licensed under Public Domain

Generally, the louder the noise, the shorter the exposure time before hearing protection is required. For instance, employees may be exposed to a noise level of 90 dB for 8 hours per day (unless they experience a Standard Threshold Shift) before hearing protection is required. On the other hand, if the noise level reaches 115 dB hearing protection is required if the anticipated exposure exceeds 15 minutes. Common hearing injuries associated with noise levels in the construction and maintenance industry include both temporary and

permanent partial to total hearing loss, and tinnitus (ringing in the ear).

For a more detailed discussion of the requirements for a comprehensive hearing conservation program, see OSHA Publication 3074 (2002), “Hearing Conservation” or refer to the OSHA standard at 29 CFR 1910.95, Occupational Noise Exposure, section (c).

Table 5, below, shows the permissible noise exposures that require hearing protection for employees exposed to occupational noise at specific decibel levels for specific time periods. Noises are considered continuous if the interval between occurrences of the maximum noise level is one second or less. Noises not meeting this definition are considered impact or impulse noises (loud momentary explosions of sound) and exposures to this type of noise must not exceed 140 dB. Examples of situations or tools that may result in impact or impulse noises are powder-actuated nail guns, a punch press or drop hammers.

Duration per day (hrs)	Sound level (dB*)
8	90
6	92
4	95
3	97
2	100
1 1/2	102
1	105
1/2	110
1/4 or less	115

If engineering and work practice controls do not lower employee exposure to workplace noise to acceptable levels, employees must wear appropriate hearing protection. It is important to understand that hearing protectors reduce only the amount of noise that gets

through to the ears. The amount of this reduction is referred to as attenuation, which differs according to the type of hearing protection used and how well it fits. Hearing protectors worn by employees must reduce an employee’s noise exposure to within the acceptable limits noted in Table 5. Refer to Appendix B of 29 CFR 1910.95, Occupational Noise Exposure, for detailed information on methods to estimate the attenuation effectiveness of hearing protectors based on the device’s noise reduction rating (NRR). Manufacturers of hearing protection devices must display the device’s NRR on the product packaging. If employees are exposed to occupational noise at or above 85 dB averaged over an eight-hour period, the employer is required to institute a hearing conservation program that includes regular testing of employees’ hearing by qualified professionals. Refer to 29 CFR 1910.95(c) for a description of the requirements for a hearing conservation program.

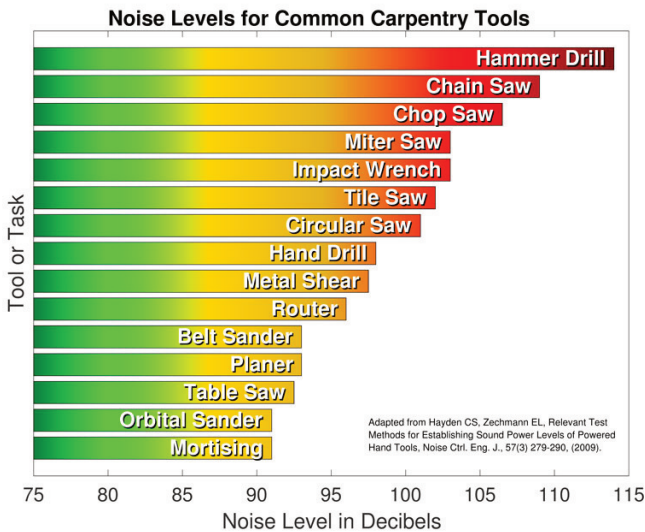

HEARING PROTECTION SELF-CHECK



An interactive or media element has been excluded from this version of the text. You can view it online here:
<http://pressbooks.oer.hawaii.edu/buildingmaint/?p=29>

1.4 Head Protection

Head Protection

Protecting employees from potential head injuries is a key element of any safety program. A head injury can impair an employee for life or it can be fatal. Wearing a safety helmet or hard hat is one of the easiest ways to protect an employee's head from injury. Hard hats can protect employees from impact and penetration hazards as well as from electrical shock and burn hazards.

Employers must ensure that their employees wear head protection if any of the following apply:

- Objects might fall from above and strike them on the head;
- They might bump their heads against fixed objects, such as exposed pipes or beams; or
- There is a possibility of accidental head contact with electrical hazards.

Some examples of occupations in which employees should be required to wear head protection include construction workers, carpenters, electricians, linemen, plumbers and pipefitters, timber and log cutters, welders, among many others. Whenever there is a danger of objects falling from above, such as working below others who are using tools or working under a conveyor belt, head protection must be worn. Hard hats must be worn with the bill forward to protect employees properly.

In general, protective helmets or hard hats should do the following:

- Resist penetration by objects.

- Absorb the shock of a blow.
- Be water-resistant and slow burning.
- Have clear instructions explaining proper adjustment and replacement of the suspension and headband.

Hard hats must have a hard outer shell and a shock-absorbing lining that incorporates a headband and straps that suspend the shell from 1 to 1 1/4 inches (2.54 cm to 3.18 cm) away from the head. This type of design provides shock absorption during anti-impact and ventilation during normal wear.

Protective headgear must meet ANSI Standard Z89.1-1986 (Protective Headgear for Industrial Workers) or provide an equivalent level of protection. Helmets purchased before July 5, 1994 must comply with the earlier ANSI Standard (Z89.1-1969) or provide equivalent protection.

BUMP HATS VS. HARD HATS



Hard Hat by Rita Wheeler is licensed under CC BY 4.0

There are two common classes of protective headgear known as “bump hats” and “hard hats”. Bump Hats are designed for use in areas with low head clearance and are recommended for areas where protection is needed from head bumps and lacerations. When the risk of falling or flying objects are present then an ANSI approved Hard Hat is required instead.

There are many types of hard hats available in the marketplace today and it is essential to check the type of hard hat employees are using. Each hat should bear a label inside the shell that lists the manufacturer, the ANSI designation and the class of the hat. This information should be compared against working conditions to ensure proper protection against potential workplace hazards with a requirement for employees to wear the hard hat at all times. It is important for employers to understand all potential hazards when making this selection, including electrical hazards. This can be done through a comprehensive hazard analysis and an awareness of the different types of protective headgear available.

Hard hats are divided into three industrial classes:

Class A hard hats provide impact and penetration resistance along with limited voltage protection (up to 2,200 volts).

Class B hard hats provide the highest level of protection against electrical hazards, with high-voltage shock and burn protection (up to 20,000 volts). They also provide protection from impact and penetration hazards by flying/falling objects.

Class C hard hats provide lightweight comfort and impact protection but offer no protection from electrical hazards.

SIZE AND CARE CONSIDERATIONS

Head protection that is either too large or too small is inappropriate for use, even if it meets all other requirements. Protective headgear must fit appropriately on the body and for the head size of each

individual. Most protective headgear comes in a variety of sizes with adjustable headbands to ensure a proper fit (many adjust in 1/8-inch increments). A proper fit should allow sufficient clearance between the shell and the suspension system for ventilation and distribution of an impact. The hat should not bind, slip, fall off or irritate the skin.

Some protective headgear allows for the use of various accessories to help employees deal with changing environmental conditions, such as slots for earmuffs, safety glasses, face shields and mounted lights. Optional brims may provide additional protection from the sun and some hats have channels that guide rainwater away from the face. Protective headgear accessories must not compromise the safety elements of the equipment.

Periodic cleaning and inspection will extend the useful life of protective headgear. A daily inspection of the hard hat shell, suspension system and other accessories for holes, cracks, tears or other damage that might compromise the protective value of the hat is essential. Paints, paint thinners and some cleaning agents can weaken the shells of hard hats and may eliminate electrical resistance. Consult the helmet manufacturer for information on the effects of paint and cleaning materials on their hard hats. Never drill holes, paint or apply labels to protective headgear as this may reduce the integrity of the protection. Do not store protective headgear in direct sunlight, such as on the rear window shelf of a car, since sunlight and extreme heat can damage them.

Hard hats with any of the following defects should be removed from service and replaced:

- Perforation, cracking, or deformity of the brim or shell;
- Indication of exposure of the brim or shell to heat, chemicals or ultraviolet light and other radiation (in addition to a loss of surface gloss, such signs include chalking or flaking).

Always replace a hard hat if it sustains an impact, even if damage

is not noticeable. Suspension systems are offered as replacement parts and should be replaced when damaged or when excessive wear is noticed. It is not necessary to replace the entire hard hat when deterioration or tears of the suspension systems are noticed.

1.5 Hand Protection

Hand Protection

If a workplace hazard assessment reveals that employees face potential injury to hands and arms that cannot be eliminated through engineering and work practice controls, employers must ensure that employees wear appropriate protection. Potential hazards include skin absorption of harmful substances, chemical or thermal burns, electrical dangers, bruises, abrasions, cuts, punctures, fractures and amputations. Protective equipment includes gloves, finger guards and arm coverings or elbow-length gloves.

Employers should explore all possible engineering and work practice controls to eliminate hazards and use PPE to provide additional protection against hazards that cannot be completely eliminated through other means. For example, machine guards may eliminate a hazard. Installing a barrier to prevent employees from placing their hands at the point of contact between a table saw blade and the item being cut is another method.

Types of Protective Gloves

- Palm
- Mechanic's
- Latex
- Vinyl
- Nitrile
- Chemical

There are many types of gloves available today to protect against a wide variety of hazards. The nature of the hazard and the operation

involved will affect the selection of gloves. The variety of potential occupational hand injuries makes selecting the right pair of gloves challenging. It is essential that employees use gloves specifically designed for the hazards and tasks found in their workplace because gloves designed for one function may not protect against a different function even though they may appear to be an appropriate protective device.

The following are examples of some factors that may influence the selection of protective gloves for a workplace.

- Type of chemicals handled.
- Nature of contact (total immersion, splash, etc.).
- Duration of contact.
- Area requiring protection (hand only, forearm, arm).
- Grip requirements (dry, wet, oily).
- Thermal protection.
- Size and comfort.
- Abrasion/resistance requirements.

Gloves made from a wide variety of materials are designed for many types of workplace hazards. In general, gloves fall into four groups:

- Gloves made of leather, canvas or metal mesh;
- Fabric and coated fabric gloves;
- Chemical- and liquid-resistant gloves;
- Insulating rubber gloves (See 29 CFR 1910.137 and the following section on electrical protective equipment for detailed requirements on the selection, use and care of insulating rubber gloves).



An interactive or media element has been excluded from this version of the text. You can view it online here:
<http://pressbooks.oer.hawaii.edu/buildingmaint/?p=34>



An interactive or media element has been excluded from this version of the text. You can view it online here:
<http://pressbooks.oer.hawaii.edu/buildingmaint/?p=34>

GLOVE SELECTION

The following table from the U.S. Department of Energy (Occupational Safety and Health Technical Reference Manual) rates various gloves as being protective against specific chemicals and will help you select the most appropriate gloves to protect your employees. The ratings are abbreviated as follows: VG: Very Good; G: Good; F: Fair; P: Poor (not recommended). Chemicals marked with an asterisk (*) are for limited service.

Chemical	Neoprene	Latex/ Rubber	Butyl	Nitrile
Acetaldehyde*	VG	G	VG	G
Acetic acid	VG	VG	VG	VG
Acetone*	G	VG	VG	P
Ammonium hydroxide	VG	VG	VG	VG
Amy acetate*	F	P	F	P
Aniline	G	F	F	P
Benzaldehyde*	F	F	G	G
Benzene*	P	P	P	F
Butyl acetate	G	F	F	P
Butyl alcohol	VG	VG	VG	VG
Carbon disulfide	F	F	F	F
Carbon tetrachloride*	F	P	P	G
Castor oil	F	P	F	VG
Chlorobenzene*	F	P	F	P
Chloroform*	G	P	P	F
Chloronaphthalene	F	P	F	F
Chromic acid (50%)	F	P	F	F
Citric acid (10%)	VG	VG	VG	VG
Cyclohexanol	G	F	G	VG
Dibutyl phthalate*	G	P	G	G
Diesel fuel	G	P	P	VG
Diisobutyl ketone	P	F	G	P
Dimethylformamide	F	F	G	G
Dioctyl phthalate	G	P	F	VG
Dioxane	VG	G	G	G
Epoxy resins, dry	VG	VG	VG	VG
Ethyl acetate*	G	F	G	F

Chemical	Neoprene	Latex/ Rubber	Butyl	Nitrile
Ethyl alcohol	VG	VG	VG	VG
Ethyl ether*	VG	G	VG	G
Ethylene dichloride*	F	P	F	P
Ethylene glycol	VG	VG	VG	VG
Formaldehyde	VG	VG	VG	VG
Formic acid	VG	VG	VG	VG
Freon 11	G	P	F	G
Freon 12	G	P	F	G
Freon 21	G	P	F	G
Freon 22	G	P	F	G
Furfural*	G	G	G	G
Gasoline, leaded	G	P	F	VG
Gasoline, unleaded	G	P	F	VG
Glycerin	VG	VG	VG	VG
Hexane	F	P	P	G
Hydrazine (65%)	F	G	G	G
Hydrochloric acid	VG	G	G	G
Hydrofluoric acid (48%)	VG	G	G	G
Hydrogen peroxide (30%)	G	G	G	G
Hydroquinone	G	G	G	F
Isooctane	F	P	P	VG
Kerosene	VG	F	F	VG
Ketones	G	VG	VG	P
Lacquer thinners	G	F	F	P
Lactic acid (85%)	VG	VG	VG	VG
Lauric acid (36%)	VG	F	VG	VG
Lineolic acid	VG	P	F	G

Chemical	Neoprene	Latex/ Rubber	Butyl	Nitrile
Linseed oil	VG	P	F	VG
Maleic acid	VG	VG	VG	VG
Methyl alcohol	VG	VG	VG	VG
Methylamine	F	F	G	G
Methyl bromide	G	F	G	F
Methyl chloride*	P	P	P	P
Methyl ethyl ketone*	G	G	VG	P
Methyl isobutyl ketone*	F	F	VG	P
Methyl methacrylate	G	G	VG	F
Monoethanolamine	VG	G	VG	VG
Morpholine	VG	VG	VG	G
Naphthalene	G	F	F	G
Napthas, aliphatic	VG	F	F	VG
Napthas, aromatic	G	P	P	G
Nitric acid*	G	F	F	F
Nitric acid, red and white fuming	P	P	P	P
Nitromethane (95.5%)*	F	P	F	F
Nitropropane (95.5%)	F	P	F	F
Octyl alcohol	VG	VG	VG	VG
Oleic acid	VG	F	G	VG
Oxalic acid	VG	VG	VG	VG
Palmitic acid	VG	VG	VG	VG
Perchloric acid (60%)	VG	F	G	G
Perchloroethylene	F	P	P	G
Petroleum distillates (naphtha)	G	P	P	VG
Phenol	VG	F	G	F

Chemical	Neoprene	Latex/ Rubber	Butyl	Nitrile
Phosphoric acid	VG	G	VG	VG
Potassium hydroxide	VG	VG	VG	VG
Propyl acetate	G	F	G	F
Propyl alcohol	VG	VG	VG	VG
Propyl alcohol (iso)	VG	VG	VG	VG
Sodium hydroxide	VG	VG	VG	VG
Styrene	P	P	P	F
Styrene (100%)	P	P	P	F
Sulfuric acid	G	G	G	G
Tannic acid (65)	VG	VG	VG	VG
Tetrahydrofuran	P	F	F	F
Toluene*	F	P	P	F
Toluene diisocyanate (TDI)	F	G	G	F
Trichloroethylene*	F	F	P	G
Triethanolamine (85%)	VG	G	G	VG
Tung oil	VG	P	F	VG
Turpentine	G	F	F	VG
Xylene*	P	P	P	F

CARE OF PROTECTIVE GLOVES

Protective gloves should be inspected before each use to ensure that they are not torn, punctured or made ineffective in any way. A visual inspection will help detect cuts or tears but a more thorough inspection by filling the gloves with water and tightly rolling the cuff towards the fingers will help reveal any pinhole leaks. Gloves that are discolored or stiff may also indicate deficiencies caused by excessive use or degradation from chemical exposure.

Any gloves with impaired protective ability should be discarded and replaced. Reuse of chemical-resistant gloves should be evaluated carefully, taking into consideration the absorptive qualities of the gloves. A decision to reuse chemically-exposed gloves should take into consideration the toxicity of the chemicals involved and factors such as duration of exposure, storage and temperature.

1.6 Respiratory Protection

Respiratory Protection

The information in this section will provide basic information to workers and employers who may find themselves using respiratory protection for the first time. The guidance provides information on what respirators are, how they work, and what is needed for a respirator to provide protection. For additional information see:

OSHA Bulletin: General Respiratory Protection Guidance for Employers and Workers

WHAT IS A RESPIRATOR?

A respirator is a device that protects you from inhaling dangerous substances, such as chemicals and infectious particles. Respirators are among the most important pieces of protective equipment for working in hazardous environments. Selecting the right respirator requires an assessment of all the workplace operations, processes or environments that may create a respiratory hazard. The identity of the hazard and its airborne concentrations need to be determined before choosing a respirator. This assessment should be done by experienced safety personnel or by an industrial hygienist. There are several different types of respirators, as described below.



Dust Mask by Rita Wheeler is licensed under CC BY 4.0

HOW DO RESPIRATORS WORK?

Respirators work by either filtering particles from the air, chemically cleaning (purifying) the air, or supplying clean air from an outside source.

Particulate Respirators

Particulate respirators are the simplest, least expensive, and least protective of the respirator types available. These respirators only protect against particles (e.g., dust). They do not protect against chemicals, gases, or vapors, and are intended only for low hazard levels. The commonly known “N-95” filtering facepiece respirator or “dust mask” is one type of particulate respirator, often used in

hospitals to protect against infectious agents. Particulate respirators are “airpurifying respirators” because they clean particles out of the air as you breathe.

Particulate respirators:

- Filter out dusts, fumes and mists.
- Are usually disposable dust masks or respirators with disposable filters.
- Must be replaced when they become discolored, damaged, or clogged.

Examples: filtering facepiece or elastomeric respirator.

Chemical Cartridge/Gas Mask Respirator





Gas masks are also known as “air-purifying respirators” because they filter or clean chemical gases out of the air as you breathe. This respirator includes a facepiece or mask, and a cartridge or canister. Straps secure the facepiece to the head. The cartridge may also have a filter to remove particles.





Gas masks are effective only if used with the correct replaceable cartridge or filter (these terms are often used interchangeably) for a particular biological or chemical substance. Selecting the proper filter can be a complicated process, but is aided through color-coding based on the substance being filtered. There are cartridges available that protect against more than one hazard, but there is no “all-in-one” cartridge that protects against all substances. You may even require more than one cartridge to protect against multiple hazards. It is important to know what hazards you will face in order to be certain you are choosing the right filters/cartridges.



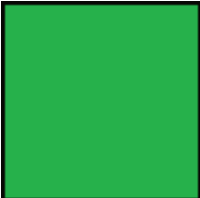

There are nine classes of particulate filters which are broken down into three series: N, R, and P. Each series (N, R, and P) is available at three efficiency levels: 95%, 99%, and 99.97%. The N series filter

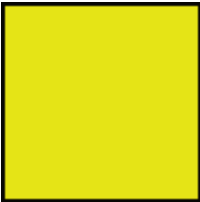
is used in environments free of oil mists. The R series filters can be exposed to oil mists, but should only be worn for one work shift. The P filter can be exposed to oil mists for longer than one work shift.

Color coding for gas mask cartridges/canisters

Contaminant	Color	Description
Acid gases		White
Hydrocyanic acid gas		White with 1/2 inch green stripe completely around the canister near the bottom
Chlorine gas		White with 1/2 inch yellow stripe completely around the canister near the bottom
Organic Vapors		Black
Ammonia gas		Green

Contaminant	Color	Description
Acid gases and ammonia gas		Green with 1/2 inch white stripe completely around the canister near the bottom
Carbon monoxide		Blue
Acid gases & organic vapors		Yellow
Hydrocyanic acid gas and chloropicrin vapor		Yellow with 1/2 inch blue stripe completely around the canister near the bottom
Acid gases, organic vapors, and ammonia gases		Brown

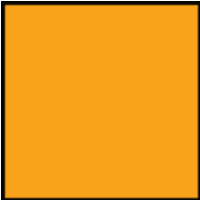
Contaminant	Color	Description
Radioactive materials, except tritium & noble gases		Magenta
Pesticides		Organic vapor canister plus a particulate filter
Multi-Contaminant and CBRN agent		Olive
Any particulates - P100		Purple
Any particulates - P95, P99, R95, R99, R100		Orange

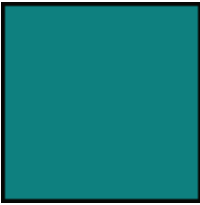
Contaminant	Color	Description
Any particulates free of oil - N95, N99, or N100		Teal

Color Blocks by Jonathan Kevan is licensed under CC BY 4.0

Powered Air-Purifying Respirator (PAPR)

Powered air-purifying respirators use a fan to draw air through the filter to the user. They are easier to breathe through; however, they need a fully charged battery to work properly. They use the same type of filters/cartridges as other air-purifying respirators. It is important to know what the hazard is, and how much of it is in the air, in order to select the proper filters/cartridges.

Self-Contained Breathing Apparatus

Self-Contained Breathing Apparatus (SCBA) is the respirator commonly used by firefighters. These use their own air tank to supply clean air, so you don't need to worry about filters. They also protect against higher concentrations of dangerous chemicals. However, they are very heavy (30 pounds or more), and require very special training on how to use and to maintain them. Also, the air tanks typically last an hour or less depending upon their rating and your breathing rate (how hard you are breathing).

Provide clean air from a portable air tank when the air around you is simply too dangerous to breathe.

All of these respirators (except for the "dust masks" or filtering face pieces) are available in either half-mask or full-face pieces.

FREQUENTLY ASKED QUESTIONS (RESPIRATORS)



An interactive or media element has been excluded from this version of the text. You can view it online here:
<http://pressbooks.oer.hawaii.edu/buildingmaint/?p=37>

RESPIRATOR CONSIDERATIONS:

Questions to consider regarding any respirator you are considering purchasing:

- What protection (which chemicals and particles, and at what levels) does the respirator provide?
- Is there more than one size?
- Which size should I use?
- How do I know if the gas mask or respirator will fit?
- What type of training do I need?
- Are there any special maintenance or storage conditions?
- Will I be able to talk while wearing the respirator?
- Does the hood restrict vision or head movement in any way?
- Can I carry the device in the trunk of my automobile?
- Is a training respirator available?

ADDITIONAL INFORMATION

For more information on OSHA's rules and requirements related to respiratory protection, visit OSHA's website at www.osha.gov/SLTC/respiratoryprotection/index.html.

This is one in a series of informational fact sheets highlighting

OSHA programs, policies or standards. It does not impose any new compliance requirements. For a comprehensive list of compliance requirements of OSHA standards or regulation, refer to Title 29 of the Code of Federal Regulations. This information will be made available to sensory-impaired individuals upon request. The voice phone is (202) 693-1999; teletypewriter (TTY) number: (877) 889-5627.

For more complete information:

OSHA

Occupational Safety and Health Administration

U.S. Department of Labor

www.osha.gov

(800) 321-OSHA

1.7 Foot Protection

Footwear

Employees who face possible foot or leg injuries from falling or rolling objects or from crushing or penetrating materials should wear protective footwear. Also, employees whose work involves exposure to hot substances or corrosive or poisonous materials must have protective gear to cover exposed body parts, including legs and feet. If an employee's feet may be exposed to electrical hazards, non-conductive footwear should be worn. On the other hand, workplace exposure to static electricity may necessitate the use of conductive footwear.



An interactive or media element has been excluded from this version of the text. You can view it online here:
<http://pressbooks.oer.hawaii.edu/buildingmaint/?p=39>

Examples of situations in which an employee should wear foot and/or leg protection include:

- When heavy objects such as barrels or tools might roll onto or fall on the employee's feet;
- Working with sharp objects such as nails or spikes that could pierce the soles or uppers of ordinary shoes;
- Exposure to molten metal that might splash on feet or legs;
- Working on or around hot, wet or slippery surfaces; and

- Working when electrical hazards are present.

Safety footwear must meet ANSI minimum compression and impact performance standards in ANSI Z41-1991 (American National Standard for Personal Protection-Protective Footwear) or provide equivalent protection. Footwear purchased before July 5, 1994, must meet or provide equivalent protection to the earlier ANSI Standard (ANSI Z41.1-1967). All ANSI approved footwear has a protective toe and offers impact and compression protection. But the type and amount of protection is not always the same. Different footwear protects in different ways. Check the product's labeling or consult the manufacturer to make sure the footwear will protect the user from the hazards they face.

Foot and leg protection choices include the following:

- Leggings protect the lower legs and feet from heat hazards such as molten metal or welding sparks. Safety snaps allow leggings to be removed quickly.
- Metatarsal guards protect the instep area from impact and compression. Made of aluminum, steel, fiber or plastic, these guards may be strapped to the outside of shoes.
- Toe guards fit over the toes of regular shoes to protect the toes from impact and compression hazards. They may be made of steel, aluminum or plastic.
- Combination foot and shin guards protect the lower legs and feet, and may be used in combination with toe guards when greater protection is needed.
- Safety shoes have impact-resistant toes and heat-resistant soles that protect the feet against hot work surfaces common in roofing, paving and hot metal industries. The metal insoles of some safety shoes protect against puncture wounds. Safety shoes may also be designed to be electrically conductive to prevent the buildup of static electricity in areas with the

potential for explosive atmospheres or nonconductive to protect employees from workplace electrical hazards.

SPECIAL PURPOSE SHOES

Electrically conductive shoes provide protection against the buildup of static electricity. Employees working in explosive and hazardous locations such as explosives manufacturing facilities or grain elevators must wear conductive shoes to reduce the risk of static electricity buildup on the body that could produce a spark and cause an explosion or fire. Foot powder should not be used in conjunction with protective conductive footwear because it provides insulation, reducing the conductive ability of the shoes. Silk, wool and nylon socks can produce static electricity and should not be worn with conductive footwear. Conductive shoes must be removed when the task requiring their use is completed.

Note: Employees exposed to electrical hazards must never wear conductive shoes.

Electrical hazard, safety-toe shoes are nonconductive and will prevent the wearers' feet from completing an electrical circuit to the ground. These shoes can protect against open circuits of up to 600 volts in dry conditions and should be used in conjunction with other insulating equipment and additional precautions to reduce the risk of an employee becoming a path for hazardous electrical energy. The insulating protection of electrical hazard, safety-toe shoes may be compromised if the shoes become wet, the soles are worn through, metal particles become embedded in the sole or heel, or employees touch conductive, grounded items.

Note: Nonconductive footwear must not be used in explosive or hazardous locations.

CARE OF PROTECTIVE FOOTWEAR

As with all protective equipment, safety footwear should be inspected prior to each use. Shoes and leggings should be checked for wear and tear at reasonable intervals. This includes looking for cracks or holes, separation of materials, broken buckles or laces. The soles of shoes should be checked for pieces of metal or other embedded items that could present electrical or tripping hazards. Employees should follow the manufacturers' recommendations for cleaning and maintenance of protective footwear.

I.8 Tool & Shop Safety

Tools are such a common part of our lives that it is difficult to remember that they may pose hazards. Tragically, a serious incident can occur before steps are taken to identify and avoid or eliminate tool-related hazards.

Five basic safety rules can help prevent hazards associated with the use of hand and power tools:

- Keep all tools in good condition with regular maintenance.
- Use the right tool for the job.
- Examine each tool for damage before use and do not use damaged tools.
- Operate tools according to the manufacturers' instructions.
- Provide and properly use appropriate personal protective equipment.

Tool Safety Video



An interactive or media element has been excluded from this version of the text. You can view it online here:

<http://pressbooks.oer.hawaii.edu/buildingmaint/?p=42>

Hand Tool Safety

Hand tools are tools that are powered manually and include anything from axes to wrenches. The greatest hazards posed by hand tools result from misuse and improper maintenance.

Some examples include the following:

- If a chisel is used as a screwdriver, the tip of the chisel may break and fly off, hitting the user or other employees.
- If a wooden handle on a tool, such as a hammer or an axe, is loose, splintered, or cracked, the head of the tool may fly off and strike the user or other employees.
- If the jaws of a wrench are sprung, the wrench might slip.
- If impact tools such as chisels, wedges, or drift pins have mushroomed heads, the heads might shatter on impact, sending sharp fragments flying toward the user or other employees.

Guidance on hand tool use:

- Wear safety glasses when striking objects with tools or the potential for breakage, chips, dust or any other hazard exists.
- Tap fasteners such as nails to start.
- Remove free hand to avoid impact to hand and fingers before striking fastener with force.
- Do not cut towards yourself with sharp tools.
- Avoid storing sharp tools with sensitive tools and equipment.
- Be cautious of wrenches and tools slipping from fasteners to avoid hand injuries and loss of balance.
- Use insulated tools when working with energized circuits.
- Do not operate power tools with cut or frayed power cords, or inoperable or missing safety guards or devices.
- Never carry sharp tools in your pockets.

Power Tool Safety

Employees using electric tools must be aware of several dangers. Among the most serious hazards are electrical burns and shocks.

Electrical shocks, which can lead to injuries such as heart failure and burns, are among the major hazards associated with electric-powered tools. Under certain conditions, even a small amount of electric current can result in fibrillation of the heart and death. An electric shock also can cause the user to fall off a ladder or other elevated work surface and be injured due to the fall.

To protect the user from shock and burns, electric tools must have a three-wire cord with a ground and be plugged into a grounded receptacle, be double insulated, or be powered by a low-voltage isolation transformer. Three-wire cords contain two current-carrying conductors and a grounding conductor. Any time an adapter is used to accommodate a two-hole receptacle, the adapter wire must be attached to a known ground. The third prong must never be removed from the plug.

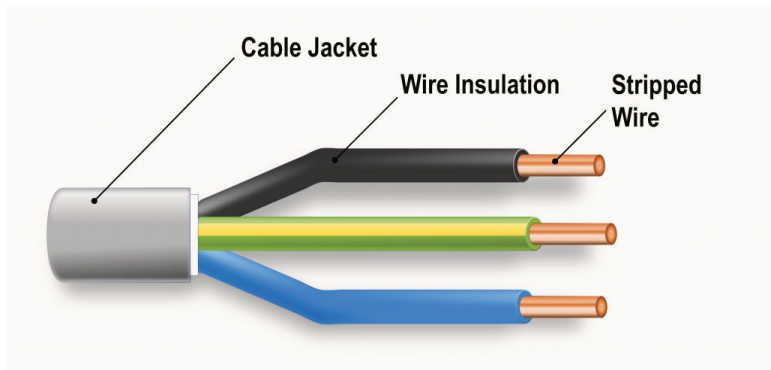

Electrical cable diagram by Marekich is licensed under CC BY-SA 3.0

Double-insulated tools are available that provide protection against electrical shock without third-wire grounding. On double-insulated tools, an internal layer of protective insulation completely isolates the external housing of the tool.

The following general practices should be followed when using electric tools:

- Wear appropriate eye and hearing protection.
- Read manual and operate electric tools within their design limitations.
- Ensure tool is in the off position prior to connecting to outlet.
- Use gloves and appropriate safety footwear when using electric tools.
- Always use a GFCI protected device for outside and damp location power tool use.
- Do not use electric tools in damp or wet locations unless they are approved for that purpose.
- Do not use portable power tools which have cords that are cut, frayed, or separated from the tool housing. Such cords should be repaired before continued use.
- Keep work areas well lighted when operating electric tools.
- Ensure that cords from electric tools do not present a tripping hazard.
- Never place power cords over shoulders or around neck.
- Secure long hair and loose clothing prior to power tool use.
- Allow the tool to do the work. Never force or apply excessive pressure to the tool.
- Maintain sure footing and well balanced stance.

Additional practices for storage, transportation and maintenance:

- Unplug or remove batteries from power tools before changing accessories.
- Keep tools and equipment well maintained, i.e. blades sharp, cords well maintained, guards in good working order, etc. Store electric tools in a dry place when not in use.
- Do not carry tools by the power cord.
- Make sure that long extension cords are sufficiently large in size to carry the current (amps) necessary for the tools being used. Sufficiently large wire size in cords will help avoid large voltage drop and tool burn-out.



An interactive or media element has been excluded from this version of the text. You can view it online here:
<http://pressbooks.oer.hawaii.edu/buildingmaint/?p=42>

Content augmented with material by: <https://www.osha.gov/Publications/osha3080.html>

Refer to *Tool Choices and Application* for safety related to specific hand and power tools.

1.9 Ladder Safety & Fall Protection

Ladder Safety



Ladder Safe Step by Violen Multerer is licensed under CC BY 4.0

Falls from portable ladders (step, straight, combination and extension) are one of the leading causes of occupational fatalities and injuries. According to the Department of Labor's (DOL) Occupational Safety and Health Administration (OSHA) ladder safety guidelines, following these safety rules can keep you from becoming a statistic:

- Read and follow all labels/markings on the ladder.
- Avoid electrical hazards! – Look for overhead power lines before handling a ladder. Avoid using a metal ladder near power lines or exposed energized electrical equipment.
- Always inspect the ladder prior to using it. If the ladder is damaged, it must be removed from service and tagged until repaired or discarded.
- Always maintain a 3-point (two hands and a foot, or two feet and a hand) contact on the ladder when climbing. Keep your body near the middle of the step and always face the ladder while climbing (see diagram below).
- Only use ladders and appropriate accessories (ladder levelers, jacks or hooks) for their designed purposes.
- Ladders must be free of any slippery material on the rungs, steps or feet.
- Do not use a self-supporting ladder (e.g., step ladder) as a single ladder or in a partially closed position.
- Do not use the top step/rung of a ladder as a step/rung unless it was designed for that purpose.
- Use a ladder only on a stable and level surface, unless it has been secured (top or bottom) to prevent displacement.
- Do not place a ladder on boxes, barrels or other unstable bases to obtain additional height.
- Do not move or shift a ladder while a person or equipment is on the ladder.

- An extension or straight ladder used to access an elevated surface must extend at least 3 feet above the point of support (see diagram below). Do not stand on the three top rungs of a straight, single or extension ladder.
- The proper angle for setting up a ladder is to place its base a quarter of the working length of the ladder from the wall or other vertical surface (see diagram below).
- A ladder placed in any location where it can be displaced by other work activities must be secured to prevent displacement or a barricade must be erected to keep traffic away from the ladder.
- Be sure that all locks on an extension ladder are properly engaged.
- Do not exceed the maximum load rating of a ladder. Be aware of the ladder's load rating and of the weight it is supporting, including the weight of any tools or equipment.

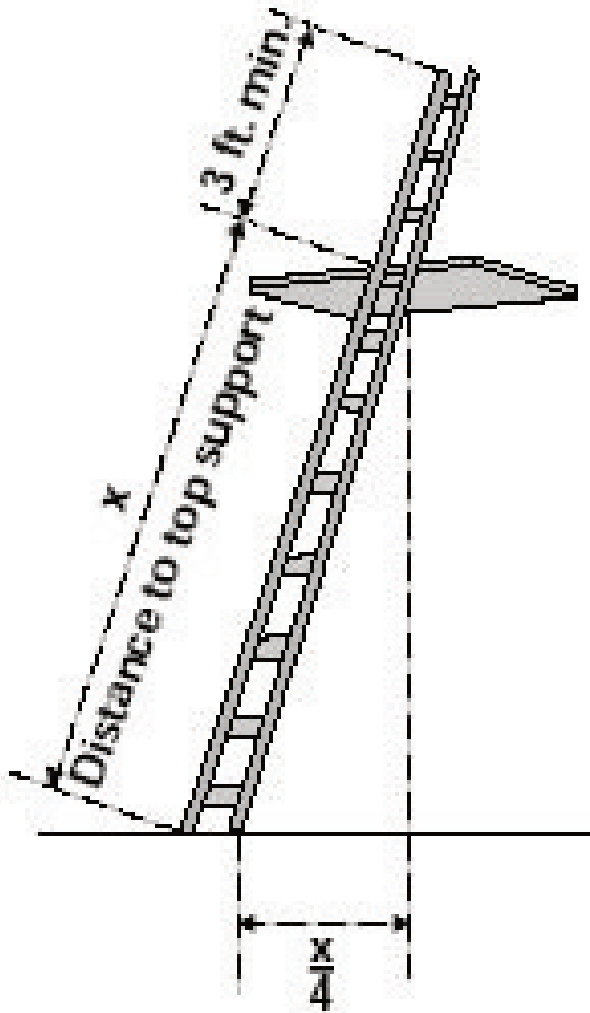



Portable Ladder Safety by OSHA is licensed under Public Domain

Safety Harness

Individuals performing tasks at elevations of six (6) feet or higher should be protected by and specifically trained in the use of an appropriate fall arrest system. Employers are responsible to ensure training for employees that are required by OSHA regulations to use these lifesaving systems. For detailed fall protection requirements and safety guidelines, refer to the OSHA Technical Manual, Section V: Chapter 4 Fall Protection in Construction.



An interactive or media element has been excluded from this version of the text. You can view it online here:
<http://pressbooks.oer.hawaii.edu/buildingmaint/?p=47>

PART 2: HAND & POWER TOOLS

2.1 Tool Choices and Applications

Although there are numerous advantages to choosing tools based on many factors, safety should be the first factor to be considered.

Always choose the right tool for the job- Remember that tools have specific functions.

- Screwdrivers are not impact resistant and should never be used as a chisel or pry bar.
- Accessories used in cordless impact drivers must be rated for impact use.

Determine the scope of work- Consider where you will be working:

- Small or large project?
- What tasks will you be performing?
- How much space do you have to safely perform your tasks?
- What are the tools best suited to the tasks?
- What PPE is required for each task?



Construction Technology Program C3T Image 8366 is licensed under **CC BY 4.0**

Material type and size- Choice of tools and accessories should be based on the type and size of material being used.

Examples:

- Specially designed masonry drill bits, saw blades, and grinding wheels are used for masonry, concrete, brick and tile.
- Anchor bolts are rated by the amount of weight they will safely support, with many styles available for application with specific materials.
- A circular saw may be better suited for the task than a table or miter saw for small jobs.
- Do the material and tools to be used require an additional person to assist in the safe completion of the task due to the weight or physical size of the material?



*UHMC Construction Technology Program, C3T Image 8252 is licensed under **CC BY 4.0***

2.2 Measuring, Marking, Leveling & Layout Tools

Measuring, Marking, Leveling & Layout Tools

Measuring and marking tools are common to multiple trades and ensure accuracy and quality craftsmanship in the building and construction process. Measuring devices are available in fractional and metric, with classic western construction practices adopting the fractional inch configuration. While some measuring tools have the actual fractions printed ($1/2''$, $1/4''$, and $1/8''$) next to each corresponding mark on the scale, many do not and the ability to read the scale without the printed fractions may take time to develop. This is one of many reasons for the adage: “Measure twice, cut once”, which is a good habit to develop and will help to avoid costly mistakes such as over cutting and wasting material or under cutting, resulting in having to remeasure and cut the material again.



Fractional Marked & Unmarked Tape Measures by Gwen Arkin is licensed under CC BY 4.0

While many of the following tools may be considered “carpentry” tools, the majority are regularly used in most all trades. Apparent common items to all trades include measuring devices like tape measures, rulers, and basic estimation tools; plumbers and electricians will use spirit levels, builders levels, and angle finders to ensure that piping is at an appropriate grade or conduit, fixtures, and other items are installed to meet industry codes.

The original version of this chapter contained H5P content. This content is not supported in cloned books. You may want to remove or replace this section. The original version of this chapter contained H5P content. This content is not supported in cloned books. You may want to remove or replace this section.

Levels are used to check for **level (horizontal)** and **plumb (vertical)**.

Trades persons will often use a combination of various levels and squares to complete a project.



An interactive or media element has been excluded from this version of the text. You can view it online here:
<http://pressbooks.oer.hawaii.edu/buildingmaint/?p=55>

Squares are used for layout work to mark square (90°/right angle) and other angles commonly used in building and construction trades indicated on specific types of squares. They are also used to check for squareness and other angles during assembly. Squares can be made of inexpensive molded plastic, lightweight aluminum or durable steel.



An interactive or media element has been excluded from this version of the text. You can view it online here:
<http://pressbooks.oer.hawaii.edu/buildingmaint/?p=55>

2.3 Nails, Hammers & Pneumatic Nailers

Nails

Nails of all sizes are commonly used to assemble wood products when glue and adhesives are not of sufficient strength for a project. They are known by number size, the lesser the number, the smaller the length and diameter. The number is followed by the letter “d”. The d is the symbol for penny, which can be traced back as far as the Ancient Roman Empire. There are various theories as to how the measurement term came to be, but what is confirmed is that the d stands for the Roman coin denarius, or in English, the penny. The denarius was the coin which many people used in the Roman empire at the time when Rome occupied what is now England, so that’s why it’s called a penny but uses a “d” as the symbol.

Some styles of nails have larger heads for greater holding power while others have smaller or no head so that it can be set flush with or lower than material surfaces for cosmetic applications. When “headless” finish or casing nails are used, it is best to drive them to just slightly above the surface while being careful not to leave hammer marks on the material’s being nailed surface and then use a “nail set” tool to embed the nail.

Size	Length (inches)	Diameter (inches)	Standard Wire Gauge	Number Per Pound
2d	1	0.072	15	900
3d	1.25	0.080	14	615
4d	1.5	0.090	12	322
5d	1.75	0.098	12	254
6d	2	0.113	11	200
7d	2.25	0.113	11	154
8d	2.5	0.131	10	106
9d	2.75	0.131	10	85
10d	3	0.148	9	74
12d	3.25	0.148	9	57
16d	3.5	0.162	8	46
20d	4	0.192	6	29
30d	4.5	0.207	5	23
40d	5	0.225	4	17
50d	5.5	0.244	3	14
60d	6	0.262	2	11

Common Nails for Building & Construction Projects



An interactive or media element has been excluded from this version of the text. You can

view it online here:

<http://pressbooks.oer.hawaii.edu/buildingmaint/?p=62>

Hammers

Hammers are used to strike or cause impact and are available in traditional designs and in a variety of models, sizes, and weights to perform specific tasks. Selecting the proper hammer for a particular task can be the determining factor for being able to complete the task or be the difference between quality and sub-par craftsmanship. The following list describes the most common types of hammers and some of the types of tasks they are often used for.



An interactive or media element has been excluded from this version of the text. You can view it online here:

<http://pressbooks.oer.hawaii.edu/buildingmaint/?p=62>

General Hammer Use

No matter which type of hammer is used, employing proper techniques will help prevent injury.

- Wear safety glasses when striking any object with any type of hammer or tool.
- For hardwood, before nailing with hammer, drill pilot hole in material to prevent splitting.
- Choose a hammer weight that is comfortable.
- “Set” the nail by tapping in the point, remove the free hand before driving the nail.
- Using the center of the hammer face, drive the nail with smooth, firm blows.
- Striking face should always be parallel with the surface being hit.
- Avoid sideways or glancing blows.
- Always strike with the hammer face.
- Avoid impact with handle or shaft of hammer.

Nail Gun Safety

The following information is compiled from OSHA safety literature. Please go to https://www.osha.gov/Publications/NailgunFinal_508_02_optimized.pdf if you wish to view the brochure in its entirety.

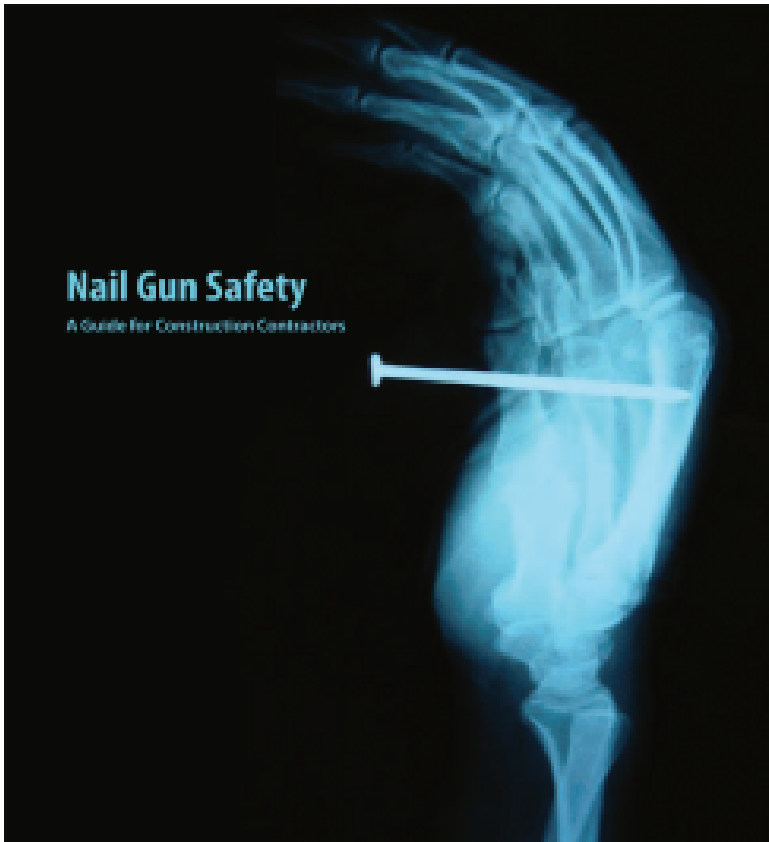

Department of Health and Human Services: Centers for Disease Control and Prevention, National Institute for Occupational Safety and Health

Department of Labor: Occupational Safety and Health Administration

This guidance document is not a standard or regulation, and it

creates no new legal obligations. It contains recommendations as well as descriptions of mandatory safety and health standards [and other regulatory requirements]. The recommendations are advisory in nature, informational in content, and are intended to assist employers in providing a safe and healthful workplace. The Occupational Safety and Health Act requires employers to comply with safety and health standards and regulations promulgated by OSHA or by a state with an OSHA-approved state plan. In addition, the Act's General Duty Clause, Section 5(a)(1), requires employers to provide their employees with a workplace free from recognized hazards likely to cause death or serious physical harm.

Nail guns are used every day on many construction jobs—especially in residential construction. They boost productivity but also cause tens of thousands of painful injuries each year. Nail gun injuries are common—one study found that 2 out of 5 residential carpenter apprentices experienced a nail gun injury over a four-year period. When they do occur, these injuries are often not reported or given any medical treatment. Research has identified the risk factors that make nail gun injuries more likely to occur. The type of trigger system and the extent of training are important factors. The risk of a nail gun injury is twice as high when using a multi-shot contact trigger as when using a single-shot sequential trigger nailer.

The guidance is for residential home builders and construction contractors, subcontractors, and supervisors. NIOSH and OSHA developed this publication to give construction employers the information they need to prevent nail gun injuries. Types of triggers and key terms are described. The guidance highlights what is known about nail gun injuries, including the parts of the body most often injured and the types of severe injuries that have been reported. Common causes of nail gun injuries are discussed and six practical steps that

contractors can take to prevent these injuries are described. These are:

- 1) Use full sequential trigger nail guns;
- 2) Provide training;
- 3) Establish nail gun work procedures;
- 4) Provide personal protective equipment (PPE);
- 5) Encourage reporting and discussion of injuries and close calls; and
- 6) Provide first aid and medical treatment.

The guidance includes actual workplace cases along with a short section on other types of nail gun hazards and sources of additional information.

Introduction to Nail Gun Safety

How likely are nail gun injuries?

Nail guns are powerful, easy to operate, and boost productivity for nailing tasks. They are also responsible for an estimated 37,000 emergency room visits each year. Severe nail gun injuries have led to construction worker deaths.

Nail gun injuries are common in residential construction. About two-thirds of these injuries occur in framing and sheathing work. Injuries also often occur in roofing and exterior siding and finishing.

A study of apprentice carpenters found that:

- 2 out of 5 were injured using a nail gun during their 4 years of training.
- 1 out of 5 were injured twice.
- 1 out of 10 were injured three or more times.

Worksite Story – A 26-year-old Idaho construction worker died following a nail gun accident in April 2007. He was

framing a house when he slipped and fell. His finger was on the contact trigger of the nail gun he was using. The nosepiece hit his head as he fell, driving a 3-inch nail into his skull. The nail injured his brain stem, causing his death. The safety controls on the nail gun were found to be intact. Death and serious injury can occur using nail guns—even when they are working properly.

More than half of reported nail gun injuries are to the hand and fingers. One quarter of these hand injuries involve structural damage to tendons, joints, nerves, and bones. After hands, the next most often injured are the leg, knee, thigh, foot, and toes. Less common are injuries to the forearm or wrist, head and neck, and trunk. Serious nail gun injuries to the spinal cord, head, neck, eye, internal organs, and bones have been reported. Injuries have resulted in paralysis, blindness, brain damage, bone fractures, and death.

Nail guns present a number of hazards and risks. NIOSH and OSHA prepared this publication to provide builders and contractors with the latest information on nail gun hazards and practical advice on the steps they should take to prevent nail gun injuries on their construction jobs.

This guide covers nail guns (also called nailers) used for fastening wood, shingles, and siding materials. The guide refers specifically to pneumatic tools but also applies to nail guns that use gas, electric, or hybrid power sources. It does NOT cover powder actuated tools used for fastening material to metal or concrete. The guide assumes that contractors are generally familiar with how nail guns work and the various types of specialized nail guns (for example, framing, roofing, flooring)

This guide is applicable to all nail guns. The emphasis is on framing (“stick” and “coil”) nail guns because they fire the largest nails, are the most powerful, and are considered to be the most dangerous to use.

Know Your Triggers

Nail gun safety starts with understanding the various trigger mechanisms. Here is what you need to know:

How Triggers Differ

All nailers rely on two basic controls: a finger trigger and a contact safety tip located on the nose of the gun. Trigger mechanisms can vary based on: 1) the order in which the controls are activated, and 2) whether the trigger can be held in the squeezed position to discharge multiple nails OR if it must be released and then squeezed again for each individual nail. Combining these variations gives four kinds of triggers. Some nail guns have a selective trigger switch which allows the user to choose among two or more trigger systems. Each trigger type is described below along with a summary of how the controls are activated.



An interactive or media element has been excluded from this version of the text. You can view it online here:
<http://pressbooks.oer.hawaii.edu/buildingmaint/?p=62>

The bottom line: contractors should check the tool label and manual for manufacturer-specific trigger names and operating information.

Worksite Story – Two framers were working together to lay down and nail a subfloor. One framer was waiting and holding the nail gun with his finger on the contact trigger. The other framer was walking backwards toward him and dragging a sheet of plywood. The framer handling the plywood backed

into the tip of the nail gun and was shot in the back. The nail nicked his kidney, but fortunately he recovered. As a result of this incident, the contractor switched to using only sequential triggers on framing nail guns. Co-workers can get injured if they bump into your contact trigger nail gun. You can prevent this by using a full sequential trigger.

How do Nail Gun Injuries Happen?

Useful Terms

- **Recoil** is the rapid rebound or kickback after the nailer is fired.
- A **double fire** occurs when a second nail unintentionally fires because the nailer re-contacted the work piece after recoil. It can also occur if the safety contact slips while the user is positioning the nail gun. Several tool manufacturers offer “anti-double fire” features for their nail guns.

There are seven major risk factors that can lead to a nail gun injury. Understanding them will help you to prevent injuries on your jobsites.

1. Unintended nail discharge from double fire. Occurs with CONTACT triggers.

The Consumer Product Safety Commission (CPSC) found that contact trigger nailers are susceptible to double firing, especially when trying to accurately place the nailer against the work piece. They found that a second unintended firing can happen faster than the user is able to react and release the trigger. Unintended nails can cause injuries.

Double fire can be a particular problem for new workers who may push hard on the tool to compensate for recoil. It can also occur

when the user is working in an awkward position, such as in tight spaces where the gun doesn't have enough space to recoil. The recoil of the gun itself can even cause a non-nail injury in tight spaces if the nail gun hits the user's head or face.

2. Unintended nail discharge from knocking the safety contact with the trigger squeezed. Occurs with CONTACT and SINGLE ACTUATION triggers.

Nail guns with contact and single actuation triggers will fire if the trigger is being held squeezed and the safety contact tip gets knocked or pushed into an object or person by mistake. For example, a framer might knock his leg going down a ladder or bump into a co-worker passing through a doorway. Contact trigger nailers can release multiple nails and single actuation trigger nailers can release a single nail to cause injury.

Holding or carrying contact trigger or single actuation trigger nail guns with the trigger squeezed increases the risk of unintended nail discharge. Construction workers tend to keep a finger on the trigger because it is more natural to hold and carry an 8-pound nail gun using a full, four-finger grip. Tool manufacturers, however, do warn against it.



Common nail gun grip by OSHA is licensed under Public Domain

3. Nail penetration through lumber work piece. Occurs with ALL trigger types.

Nails can pass through a work piece and either hit the worker's hand or fly of as a projectile (airborne) nail. A blow-out nail is one example. Blow-outs can occur when a nail is placed near a knot in the wood. Knots involve a change in wood grain, which creates both weak spots and hard spots that can make the nail change direction and exit the work piece. Nail penetration is especially a concern for placement work where a piece of lumber needs to be held in place by hand. If the nail misses or breaks through the lumber it can injure the non-dominant hand holding it.

4. Nail ricochet after striking a hard surface or metal feature.

Occurs with ALL trigger types.

When a nail hits a hard surface, it has to change direction and it can bounce off the surface, becoming a projectile. Wood knots and metal framing hardware are common causes of ricochets. Problems have also been noted with ricochets when nailing into dense laminated beams. Ricochet nails can strike the worker or a co-worker to cause an injury.

5. Missing the work piece. Occurs with ALL trigger types.

Injuries may occur when the tip of the nail gun does not make full contact with the work piece and the discharged nail becomes airborne. This can occur when nailing near the edge of a work piece, such as a plate. Positioning the safety contact is more difficult in these situations and sometimes the fired nail completely misses the lumber. Injuries have also occurred when a nail shot through plywood or oriented strand board sheeting missed a stud and became airborne.



Nail penetration through the lumber is a special concern where the piece is held in place by hand. Nail gun by OSHA is licensed under Public Domain

6. Awkward position nailing. Occurs with ALL trigger types. Unintended discharges are a concern in awkward position work with CONTACT and SINGLE ACTUATION triggers.

Nailing in awkward positions where the tool and its recoil are more difficult to control may increase the risk of injury. These include toe-nailing, nailing above shoulder height, nailing in tight quarters, holding the nail gun with the non-dominant hand, nailing while on a ladder, or nailing when the user's body is in the line of fire (nailing towards yourself). Toe-nailing is awkward because the gun cannot be held flush against the work piece. Nailing from a ladder makes it difficult to position the nail gun accurately. Nailing beyond a comfortable reach distance from a ladder, elevated work platform, or leading edge also places the user at risk for a fall.



Toe-nailing by OSHA is licensed under Public Domain

7. Bypassing safety mechanisms. Occurs with ALL trigger types.

Bypassing or disabling certain features of either the trigger or safety contact tip is an important risk of injury. For example, removing the spring from the safety contact tip makes an unintended discharge even more likely. Modifying tools can lead to safety problems for anyone who uses the nail gun. Nail gun manufacturers strongly recommend against bypassing safety features, and voluntary standards prohibit modifications or tampering. OSHA's Construction standard at 29 CFR 1926.300(a) requires that all hand and power tools and similar equipment, whether furnished by the employer or the employee shall be maintained in a safe condition.

About 1 in 10 nail gun injuries happen to co-workers. This is from either airborne (projectile) nails or bumping into a co-worker while carrying a contact trigger nail gun with the trigger squeezed.

You Should Know – Studies of residential carpenters found that the overall risk of nail gun injury is twice as high when using contact trigger nail guns compared to using sequential trigger nail guns.

**Note that the studies could not quantify injury risks associated with specific tasks; it is likely that some nailing tasks are more dangerous than others.*

A voluntary ANSI standard 10 calls for all large pneumatic framing nailers manufactured after 2003 to be shipped with a sequential trigger. However, these may not always be FULL SEQUENTIAL triggers. Contractors may need to contact manufacturers or suppliers to purchase a FULL SEQUENTIAL trigger kit.

Worksite Story – A carpenter apprentice on his first day ever using a nail gun injured his right leg. He was working on a step ladder and was in the process of lowering the nail gun to his side when the gun struck his leg and fired a nail into it. He had

no training prior to using the nail gun. New worker training is important and should include hands-on skills.

Six Steps to Nail Gun Safety

1. Use the full sequential trigger

The full sequential trigger is always the safest trigger mechanism for the job. It reduces the risk of unintentional nail discharge and double fires—including injuries from bumping into co-workers.

- At a minimum, provide full sequential trigger nailers for placement work where the lumber needs to be held in place by hand. Examples include building walls and nailing blocking, fastening studs to plates and blocks to studs, and installing trusses.
 - Unintended nail discharge is more likely to lead to a hand or arm injury for placement work compared to flat work, where the lumber does not need to be held in place by hand. Examples of flat work include roofing, sheathing, and subflooring.
- Consider restricting inexperienced employees to full sequential trigger nail guns starting out. Some contractors using more than one type of trigger on their jobs color-code the nail guns so that the type of trigger can be readily identified by workers and supervisors.
- Some contractors have been reluctant to use full sequential triggers fearing a loss of productivity. How do the different types of triggers compare?

- The one available study had 10 experienced framers stick-build two identical small (8 f x 10 ft. wood structures—one using a sequential trigger nail gun and one using a contact trigger nail gun. Small structures were built in this study so that there would be time for each carpenter to complete two sheds.
- Average nailing time using the contact trigger was 10% faster, which accounted for less than 1% of the total building time when cutting and layout was included. However, in this study the trigger type was less important to overall productivity than who was using the tool; this suggests productivity concerns should focus on the skill of the carpenter rather than on the trigger.
- Although the study did not evaluate framing a residence or light commercial building, it shows that productivity is not just about the trigger. The wood structures built for the study did include common types of nailing tasks (flat nailing, through nailing, toe-nailing) and allowed comparisons for both total average nailing time and overall project time. The study did not compare productivity differences for each type of nailing task used to build the sheds.

2. Provide training

Both new and experienced workers can benefit from safety training to learn about the causes of nail gun injuries and specific steps to reduce them. Be sure that training is provided in a manner that employees can understand. Here is a list of topics for training:

- How nail guns work and how triggers differ.
- Main causes of injuries – especially differences among types of triggers.
- Instructions provided in manufacturer tool manuals and where

the manual is kept.

Hands-on training with the actual nailers to be used on the job. This gives each employee an opportunity to handle the nailer and to get feedback on topics such as:

- How to load the nail gun
- How to operate the air compressor
- How to tie the nail gun
- How to hold lumber during placement work
- How to recognize and approach ricochet-prone work surfaces
- How to handle awkward position work (e.g., toe-nailing and work on ladders)
- How best to handle special risks associated with contact and single actuation triggers such as nail gun recoil and double fires. For example, coach new employees on how to minimize double fires by allowing the nail gun to recoil rather than continuing to push against the gun after it fires.
- What to do when a nail gun malfunctions.

**Training should also cover items covered in the following sections of the guidance, such as company nail gun work procedures, personal protective equipment, injury reporting, and first aid and medical treatment.*

You Should Know

- Training is important: Untrained workers are more likely to experience a nail gun injury than a trained worker.
- Training does not trump triggers: Trained workers using contact triggers still have twice the overall risk of injury as trained workers using sequential triggers.

3. Establish nail gun work procedures

Contractors should develop their own nail gun work rules and procedures to address risk factors and make the work as safe as possible. Examples of topics for contractor work procedures include but are not limited to the following Do's & Don'ts:

DO's

- Make sure that tool manuals for the nailers used on the job are always available on the jobsite.
- Make sure that manufacturers' tool labels and instructions are understood and followed.
- Check tools and power sources before operating to make sure that they are in proper working order.
- Take broken or malfunctioning nail guns out of service immediately.
- Set up operations so that workers are not in the line of fire from nail guns being operated by co-workers.
- Check lumber surfaces before nailing. Look for knots, nails, straps, hangers, etc. that could cause recoil or ricochet.
- Use a hammer or positive placement nailer when nailing metal joinery or irregular lumber.
- For placement work, keep hands at least 12 inches away from the nailing point at all times. Consider using clamps to brace instead of your hands.
- Always shoot nail guns away from your body and away from co-workers.
- Always disconnect the compressed air when:
 - Leaving a nailer unattended
 - Travelling up and down a ladder or stairs

- Passing the nail gun to a co-worker
- Clearing jammed nails
- Performing any other maintenance on the nail gun
- Recognize the dangers of awkward position work and provide extra time and precautions:
 - Use a hammer if you cannot reach the work while holding the nailer with your dominant hand.
 - Use a hammer or reposition for work at face or head height. Recoil is more difficult to control and could be dangerous.
 - Use a hammer or full sequential trigger nailer when working in a tight space. Recoil is more difficult to control and double fires could occur with contact triggers.
 - Take extra care with toe-nailing.
 - Nail guns can slip before or during firing because the gun cannot be held flush against the work piece.
 - Use a nail gun with teeth on the safety contact to bite into the work piece to keep the gun from slipping during the shot.
 - Use the trigger to fire only after the safety contact piece is positioned.
- Recognize the dangers of nail gun work at height and provide extra time and precautions:
 - Set up jobs to minimize the need for nailing at height
 - Consider using scaffolds instead of ladders
 - If work must be done on ladders, use full sequential trigger nailers to prevent nail gun injuries which could occur from bumping a leg while climbing up or down a ladder.
 - Position ladders so you don't have to reach too far. Your belt buckle should stay between the side rails when reaching to

the side.

- Maintain three points of contact with the ladder at all times to prevent a fall—this means that clamps may need to be used for placement work. Holding a nailer in one hand and the work piece with the other provides only two points of contact (your feet). Reaching and recoil can make you lose your balance and fall. Falls, especially with contact trigger nailers, can result in nail gun injuries.

Don'ts

- Never bypass or disable nail gun safety features. This is strictly prohibited.
 - Tampering includes removing the spring from the safety-contact tip and/or tying down, taping or otherwise securing the trigger so it does not need to be pressed. Tampering increases the chance that the nail gun will fire unintentionally both for the current user and anyone else who may use the nail gun. Nail gun manufacturers strongly recommend against tampering and OSHA requires that tools be maintained in a safe condition.
 - There is **NO** legitimate reason to modify or disable a nail gun safety device.
- Encourage workers to keep their fingers off the trigger when holding or carrying a nail gun.
If this is not natural, workers should use a full sequential nail gun or set down the nailer until they begin to nail again.
- Never lower the nail gun from above or drag the tool by the hose.

- If the nail-gun hose gets caught on something, don't pull on the hose. Go find the problem and release the hose.
- Never use the nailer with the non-dominant hand.

4. Provide Personal Protective Equipment (PPE)



Worker using recommended PPE when working with nail guns: hard hat, safety glasses, and hearing protection. Worker by OSHA is licensed under Public Domain

Safety shoes, which help protect workers' toes from nail gun injuries, are typically required by OSHA on residential construction sites. In addition, employers should provide, at no cost to employees, the following protective equipment for workers using nail guns:

- Hard hats
- High Impact eye protection – safety glasses or goggles marked ANSI Z87.1
- Hearing protection – either earplugs or earmuff

5. Encourage reporting and discussion of injuries and close calls

Studies show that many nail gun injuries go unreported. Employers should ensure that their policies and practices encourage reporting of nail gun injuries. Reporting helps ensure that employees get medical attention. It also helps contractors to identify unrecognized job site risks that could lead to additional injuries if not addressed. Injuries and close calls provide teachable moments that can help improve crew safety.

If you have a safety incentive program, be sure that it does not discourage workers from reporting injuries. Employers that intentionally under report work-related injuries will be in violation of OSHA's injury and illness recordkeeping regulation.

6. Provide first aid and medical treatment

Employers and workers should seek medical attention immediately after nail gun injuries, even for hand injuries that appear to be minimal. Studies suggest that 1 out of 4 nail gun hand injuries can involve some type of structural damage such as bone fracture. Materials such as nail strip glue or plastic or even clothing can get embedded in the injury and lead to infection. Barbs on the nail can cause secondary injury if the nail is removed incorrectly. These complications can be avoided by having workers seek immediate medical care.

Worksite Story – A construction worker accidentally drove a 16 penny framing nail into his thigh. It didn't bleed much and he didn't seek medical care. He removed the nail himself. Three days later he felt a snap in his leg and severe pain. In the emergency room, doctors removed a sheared piece of nail and found that his thigh bone had fractured. Not all injuries are immediately visible. Failure to seek medical care can result in complications and more serious injuries.

Other Hazards

Air Pressure

Pneumatic tools and compressor use are regulated under OSHA's Construction standard at 29 CFR 1926.302(b). The provisions in this standard that are relevant for nail guns are provided below:

1) Pneumatic power tools shall be secured to the hose or whip by some positive means to prevent the tool from becoming accidentally disconnected.

Note: An OSHA letter of interpretation allows the use of a quick disconnect with a pull-down sleeve to meet this requirement. It is composed of a male fitting (connector) and female fitting (coupling) that has a sleeve which must be pulled away from the end of the hose to separate the two fittings to prevent the tool from becoming accidentally disconnected.

3) All pneumatically driven nailers, staplers, and other similar equipment provided with automatic fastener feed, which operate at more than 100 p.s.i. pressure at the tool shall have a safety device on the muzzle to prevent the tool from ejecting fasteners, unless the muzzle is in contact with the work surface.

5) The manufacturer's safe operating pressure for hoses, pipes, valves, filters, and other fittings shall not be exceeded.

6) The use of hoses for hoisting or lowering tools shall not be permitted.

Noise

Pneumatic nail guns produce short (less than a tenth of a second in duration) but loud "impulse" noise peaks: one from driving the nail and one from exhausting the air. Most nail gun manufacturers recommend that users wear hearing protection when operating a nailer.

Available information indicates that nail gun noise can vary

depending on the gun, the work piece, air pressure, and the work setting. The type of trigger system does not appear to affect the noise level. Peak noise emission levels for several nailers ranged from 109 to 136 dBA.^{15,16} These loud short bursts can contribute to hearing loss. Employers should provide hearing protection in the form of earplugs or muff and ensure that they are worn correctly. Employers should also ask about noise levels when buying nail guns—studies have identified ways to reduce nail gun noise and some manufacturers may incorporate noise reduction features.

Note: OSHA's standard for exposure to continuous noise levels (29 CFR 1926.52) addresses both the noise level and the duration of exposure. In this standard, workers exposed for 15 minutes at 115 A-weighted decibels (dBA) have the same exposure as workers exposed for 8 hours at 90 dBA.

The NIOSH and OSHA limit for impulse noise is 140 decibels: above this level a single exposure can cause instant damage to the ear.

NIOSH recommends that an 8-hour exposure should not exceed 85 dBA and a one-second exposure should not exceed 130 dBA without using hearing protection. hearing protection.

Musculoskeletal disorders

Framing nail guns can weigh up to 8 pounds and many framing jobs require workers to hold and use these guns for long periods of time in awkward hand/arm postures. Holding an 8-pound weight for long periods of time can lead to musculoskeletal symptoms such as soreness or tenderness in the fingers, wrist, or forearm tendons or muscles. These symptoms can progress to pain, or in the most severe cases, inability to work. No studies have shown that one trigger type is any more or less likely to cause musculoskeletal problems from long periods of nail gun use. If use of a nail gun is causing musculoskeletal pain or symptoms of musculoskeletal disorders, medical care should be sought.

Conclusion

Nail gun injuries are painful. Some cause severe injuries or death. Nail gun injuries have been on the rise along with the increased popularity of these powerful tools. These injuries can be prevented, and more and more contractors are making changes to improve nail gun safety. Take a look at your practices and use this guide to improve safety on your job sites. Working together with tool gun manufacturers, safety and health professionals, and other organizations, we can reduce nail gun injuries.

2.4 Threaded Fasteners, Drivers, Pliers & Wrenches

Threaded Fasteners

Selecting the appropriate fastener for a particular application involves considering many factors to include: functionality, strength and durability, exposure to natural elements, and aesthetics. While most bolts and many screws are designed for the head to press firmly against flat surfaces of materials and parts, screws with tapered or bugle style heads are manufactured to be countersunk even with or below material surfaces. Screws, bolts and other threaded fastener accessories are normally made of brass; or mild, hardened or stainless steel; or plastics in some designed for lighter and cosmetic applications. In many cases, threaded fasteners are treated with processes such as galvanization, electroplated phosphate, or chemical primers such as zinc oxide.

Screws are taper tipped and threaded in a manner that helps wood, or other materials, draw together as the screw is inserted. They are used in place of nails when stronger joining power is needed. A screw makes its own thread pattern in the material. Screw head shapes (slotted, pan, hex, oval, flat) vary according to the application. Also the slots or drive types of screws are available in a wide variety (slotted, Phillips, Robertson, square, Pozidrive®, etc.).



An interactive or media element has been excluded from this version of the text. You can view it online here:
<http://pressbooks.oer.hawaii.edu/buildingmaint/?p=66>

Bolts are male threaded fasteners that require a female threaded counterpart (a “**nut**” or a threaded hole in a material) in order to secure themselves. Nuts and bolts allow for future disassembly and when used with flat and locking style washers, provide strong mechanical bonds and stability. These threaded fasteners are available in coarse and fine thread configurations which are recognized by the amount of threads per inch (**tpi**) in SAE fasteners and by pitch in metric fasteners. Cap head and stove type bolts are also rated by their hardness or shear strength. Various cast or embossed markings can be found on the head of these kinds of bolts, with each type of marking symbolizing a bolt’s capacity.



SAE Bolt Sizes by Clifford Rutherford is licensed under CC BY 4.0



Metric Bolt Sizes by Clifford Rutherford is licensed under CC BY 4.0

Specialty Anchors

Specialty anchors such as eye hooks, J-hooks for drywall, masonry, tile, wood, and other materials are available in both screw and bolt designs.

Tap and Die sets can be used to thread materials to accept another fastener. **Taps** are tools made to cut female threads while **Dies** are tools designed to cut male threads on round stock materials. It is important that the drilled hole size for tapping, or the diameter of the material to be threaded with a die, be of a specific size and tolerance so that the final threaded product fits properly. Taps and dies are also individually available in each machine fastener diameter and thread count.



An interactive or media element has been excluded from this version of the text. You can view it online here:
<http://pressbooks.oer.hawaii.edu/buildingmaint/?p=66>

All of the fasteners listed above require tool to tighten when assembling projects and loosen them when disassembly is required. Drivers, pliers and wrenches facilitate the assembly of items with threaded objects such as nuts, bolts, screws, plumbing and electrical fittings and pipes. Various styles of pliers can also be used to cut, bend, pull and crimp materials and mechanical fittings. While the proper selection of tools for particular fastener or fitting will result in easier and more rapid assembly and disassembly of projects, improper tool selection may result in material, parts, and tool damage, lost time, and possible injury.

Drivers



An interactive or media element has been excluded from this version of the text. You can view it online here:
<http://pressbooks.oer.hawaii.edu/buildingmaint/?p=66>

Pliers

Pliers are primarily used to grip objects that utilize leverage. Different configurations of the jaw are also used to grip, turn, pull, crimp and sometimes cut a variety of things. Many types are commonly identified by a manufacturer brand or model name and used by workers in multiple construction trades fields (Channellock® is a registered trademark for a manufacturer that makes numerous styles of tools, however tongue and groove pliers are commonly referred to as channel-lock pliers).



An interactive or media element has been excluded from this version of the text. You can view it online here:
<http://pressbooks.oer.hawaii.edu/buildingmaint/?p=66>

Wrenches

Wrenches can be used to turn bolts, nuts, or other hard to turn items. Wrenches provide excellent leverage compared to pliers, and most are designed to fit specific sized fasteners. The choice of an appropriate wrench depends upon the torque or leverage required to perform a function or the design of a fastener. The wrong choice of a wrench for a task can cause slipping of the wrench, damage materials and parts, and result in bodily injury. As nuts, bolts, and fasteners are offered in standardized fractional (SAE (Society of Automotive Engineers) and metric (millimeter or mm.) sizes, most wrenches are

designed to fit hexagonal (six-sided) or hex fasteners and mechanical fittings. Wrenches can be purchased either individually or in sets based on style or combinations of styles.



An interactive or media element has been excluded from this version of the text. You can view it online here:
<http://pressbooks.oer.hawaii.edu/buildingmaint/?p=66>

TOOL TIPS:

- *Only use bits and sockets rated for impact use with impact drivers and impact wrenches. Non-impact tools are made of materials that can crack, break, or shatter when used with impact tools.*
- Apply a penetrating oil according to manufacturer directions to rusted fasteners prior to trying to loosen them.
- “Stuck” or rusted nuts, bolts, and screws can sometimes be freed by striking them sharply on the head with a steel punch.
- Traditional fasteners turn in a clockwise direction to tighten and counter-clockwise to loosen. Fasteners of this design are also known as “right-hand” threaded fasteners.
- Specialty fasteners required for certain mechanical applications turn counter-clockwise to tighten and clockwise to loosen. These are also referred to as “left-hand” threaded fasteners.

2.5 Saws

Choices

Saws should be chosen based on the material type to be cut and the particular task being performed. Each type of saw has its own purpose, may be available in a variety of sizes, and offer safety and convenience features which vary by manufacturer, style, and application. For example: Circular saws are used to cut a wide variety of construction materials with an appropriate blade. They are manufactured in a variety of sizes that can be selected according to the project. Simple projects with 1" x 4" or 1/2" plywood material may only require a 5-3/8" cordless trim saw, whereas beam construction could require a circular beam saw with a 21" course toothed blade, and cement fiber plank siding installation using a 7-1/4" circular saw with the appropriate blade.

While most stationary saw models are primarily used in the carpentry trades, most portable models are also employed in plumbing, electrical, and other construction and facility maintenance trades. As in the case of numerous hand tools and accessories, many of the saws types have become known by industry workers as common trademark, brand, or model names:

- Circular Saw- Skilsaw™ (Skilsaw Inc.)
- Reciprocating Saw- Sawzall® (Milwaukee Electric Tool Company); TigerSaw® (Porter Cable Tool Company)

Saw Blades

Blades come in various sizes and configurations. When choosing a saw for a particular cut, it is important to consider the type of material to be cut and the finish desired. Saw blades are rated in teeth per inch (t.p.i.), The lesser t.p.i., or the lower the revolutions per minute (r.p.m.), the rougher the finish of the cut will be. Always check the r.p.m. rating of both the blade and the saw to ensure they are compatible. Choosing a toothed blade or abrasive cut-off blade that is not rated for the r.p.m. rating of the saw can result in catastrophic blade failure and injury.

The thickness of the saw blade is referred to as the Kerf. This measurement is the width of the path of the cut where material will be removed. For accurate final dimensions, the kerf of the blade should always travel on the waste side of a marked line.



An interactive or media element has been excluded from this version of the text. You can view it online here:
<http://pressbooks.oer.hawaii.edu/buildingmaint/?p=75>

Additional Basic Saw Terminology

- **Rip Cut-** cut follows or goes with the grain of the material.
- **Cross cut-** cut goes across the grain of the material.
- **Push-block/ Push Stick-** A hand-held device designed to push the work piece into and past cutting edges on stationary power

tools.

- **Scroll action-** blade strokes perpendicular to material surface. Common to saber saws, scroll saws, and reciprocating saws.
- **Orbital action-** blade follows arcing path. Available option for saber and reciprocating saws. Aids in cutting pipe and round or circular materials.

Saw Safety

- Never disable manufacturer installed guards or safety devices.
- Always use safety glasses.
- Do not use a saw for any purpose it's features are not intended for.
- Always refer to manufacturer's operating instructions and safety procedures prior to operating any power tool.

*Kickback is caused when the material binds with the blade or fence of a saw resulting in the material being forcefully ejected, often drawing the operator's hand/s toward the moving blade, creating the potential for serious injury or death. Although kickback is regularly associated with table saw use, the same potential hazard exists with circular, reciprocating, saber and any other type of saw. In addition to material being ejected and the operator being drawn toward the blade, kickback can also result in portable saws being ejected from the material toward the operator.

Saw Types and Applications

CIRCULAR SAW- PORTABLE (FRAMING AND TRIM)

Circular saws are used to cut a wide variety of construction materials with an appropriate blade. They are constructed in various sizes that can be selected according to the project. Simple projects with 1" x 4" or 1/2" plywood material may only require a 5-3/8" cordless trim saw, whereas beam construction could require a beam saw with a 21" course toothed blade.

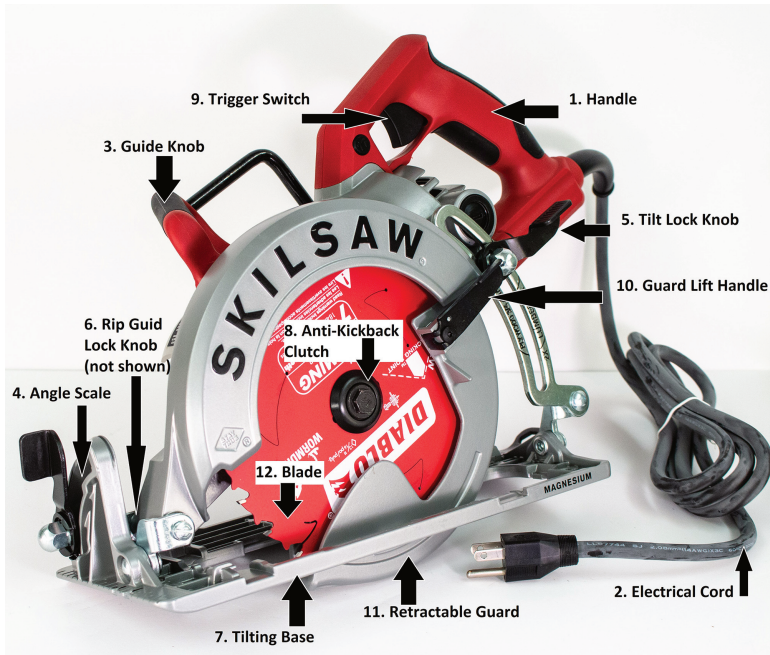

Circular Saw Parts by Gwen Arkin & Clifford Rutherford is licensed under CC BY 4.0



An interactive or media element has been excluded from this version of the text. You can view it online here:
<http://pressbooks.oer.hawaii.edu/buildingmaint/?p=75>

Circular Saw Safety



An interactive or media element has been excluded from this version of the text. You can view it online here:
<http://pressbooks.oer.hawaii.edu/buildingmaint/?p=75>

MITER SAW- CUTS ANGLES, COMPOUND ANGLES & BEVELS

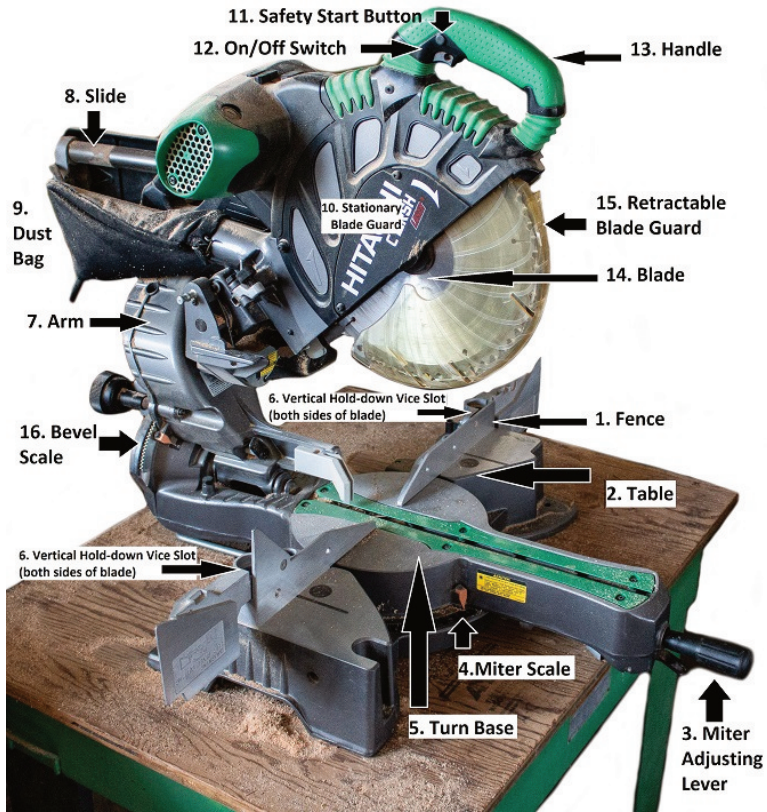

Miter Saw Parts by Gwen Arkin & Clifford Rutherford is licensed under CC BY 4.0



An interactive or media element has been excluded from this version of the text. You can view it online here:
<http://pressbooks.oer.hawaii.edu/buildingmaint/?p=75>

Miter Saw Safety



An interactive or media element has been excluded from this version of the text. You can view it online here:
<http://pressbooks.oer.hawaii.edu/buildingmaint/?p=75>

TABLE SAW- FOR RIP & CROSS CUTS OF SHEET GOODS AND LUMBER STOCK

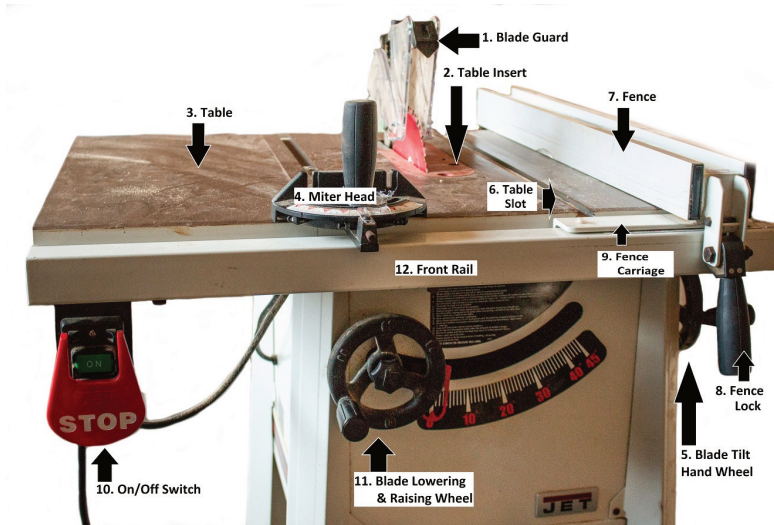

Table Saw Parts by Gwen Arkin & Clifford Rutherford is licensed under CC BY 4.0



An interactive or media element has been excluded from this version of the text. You can view it online here:

<http://pressbooks.oer.hawaii.edu/buildingmaint/?p=75>

Table Saw Safety



An interactive or media element has been excluded from this version of the text. You can view it online here:
<http://pressbooks.oer.hawaii.edu/buildingmaint/?p=75>

SABRE SAWS (JIGSAW) AND SCROLL SAWS- CURVED CUTS, USES U-SHANK AND/OR T-SHANK (BAYONET) BLADES



Jigsaw by Dexter Corpuz is licensed under CC BY 4.0



An interactive or media element has been excluded from this version of the text. You can view it online here:
<http://pressbooks.oer.hawaii.edu/buildingmaint/?p=75>

RECIPROCATING SAW- ROUGH CUTS AND DEMOLITION



Reciprocating Saw by Gwen Arkin is licensed under CC BY 4.0

**Many jigsaws & reciprocating saws can be used in either scrolling or orbital modes*



An interactive or media element has been excluded from this version of the text. You can view it online here:
<http://pressbooks.oer.hawaii.edu/buildingmaint/?p=75>

Other Saws

A variety of saws are available for masonry and mechanical applications and may be specific to a specific trade or task. Examples:

Band Saws – vertical and horizontal models for wood, metal, & other material applications



Band Saw by Gwen Arkin is licensed under CC BY 4.0

Tile Saws – ceramic, porcelain, quarry, clay, and glass

Block Saws – concrete, brick, and glass

Masonry Saws – Blades used for tile, cement, brick, & asphalt are usually diamond coated or abrasive. They can also be used wet or dry.



Tile Saw by Clifford & Rosemary Rutherford is licensed under CC BY 4.0

2.6 Drills & Accessories

Drills

Drills are used to bore holes, tighten and loosen fasteners, and, with some models and accessories, mix paint, mortar, and similar materials, and to chisel and chip mortar, concrete, and other dense or hard materials. The selection of the proper drill for a job requires knowledge of the material being worked, the types and models of drills and their purposes, and the accessories that are appropriate for the task. Tool makers offer all of the types of drills in corded models and the majority of them are also available in variable speed and battery powered models that offer greater portability and reduced tool weight with lighter weight DC brushless motor technology.

BASIC DRILL PARTS IDENTIFICATION



Portable Drill Parts by Gwen Arkin & Clifford Rutherford is licensed under CC BY 4.0

DRILL SAFETY

1. Wear safety glasses when operating with portable electric drill.

2. Disconnect the drill from the electrical supply when installing bits.
3. Clamp stock so it will not move during the drilling operation.
4. Before drilling, turn the drill on to see if the bit is centered and running true.
5. Align the bit with the desired hole location before turning the drill on.
6. Hold the drill firmly with both hands while drilling.
7. When drilling deep holes with a twist drill, move the bit up and down several times while drilling to remove cuttings and reduce overheating in the bit.
8. Do not allow the cord to become wrapped around the drill when working.
9. If the electrical cord becomes frayed or starts to separate from the drill housing, repair it immediately!
10. Remove the bit from the drill as soon as the work is completed.
11. Select the correct bit for the finish and material being drilled. Make sure the bit is securely tightened in the drill chuck.
12. Be extremely careful when using larger portable electric drills (3/8" and 1/2"). If the bit should hang or get caught the drill will twist in the operator's hands causing a sprain or bruised fingers.
13. Always remove the key from the chuck before drilling.
14. To prevent seizing, reduce the feed pressure when the drill bit is about to come through the material.

DRILL OPERATING PROCEDURES

1. Always center punch or make a starting indentation in the material being drilled to get an accurate starting point for the drill bit.
2. Tighten the drill bit by rotating the chuck key to all three holes in the chuck. This will help to keep the drill bit centered.
3. Apply moderate even pressure to the drill during the drilling

operation. If excessive pressure is required to make the bit cut then the bit is dull and needs to be sharpened.

4. Maintain good balance at all times when drilling.
5. Use slow drill speeds for drilling metal and fast speeds for drilling wood.
6. To obtain holes that are placed accurately, drill a small pilot first then drill the final hole.

DRILL TYPES



An interactive or media element has been excluded from this version of the text. You can view it online here:
<http://pressbooks.oer.hawaii.edu/buildingmaint/?p=78>

BITS & ACCESSORIES

Along with using the driver bits for various fasteners discussed in the previous chapter, drills can be accessorized to perform a variety of functions.



An interactive or media element has been excluded from this version of the text. You can view it online here:
<http://pressbooks.oer.hawaii.edu/buildingmaint/?p=78>

2.7 Grinders, Sanders, & Accessories

Grinders

Grinders are normally used to either smooth or cut hard surfaces and materials depending upon the type of accessory and material being used. The basic grinding tool consists of a motor with an abrasive wheel, wire brush or other attachment attached to the arbor (**shaft**) by a female threaded fastener (**arbor nut**). Some manufacturers' arbor nut configuration requires a propitiatory wrench or spanner for removal and installation of their own specially designed style of fastener. Grinders are offered in both portable and stationary models, and some come with a variable speed option. Each style of grinder can be accessorized for specific applications and functions and components differ by manufacturer.

GRINDER SAFETY

When choosing accessories for grinders, it is extremely important to note the the revolutions per minute (**r.p.m.**) rating of the accessory meets or exceeds the r.p.m. of the grinder. An inappropriately sized grinder accessory can shatter or break resulting in injury. Grinders should always be unplugged or the battery should be disconnected from the tool before changing accessories. Portable grinders, like many other rotating power tools, have the potential for kickback and operators should take the same basic precautions as when operating a portable power saw. Bench grinders have tool rests, or tables for stabilizing items being ground. These should be adjusted as close

to the grinding wheel as possible to prevent injury in the event of the wheel grabbing the item and pulling the operators hand/s in the direction of the wheel. Bench grinders are also required to have adjustable, impact resistant, clear lens guards, protective eye wear should always be worn by the operator when using any grinder. Due to the wide variety of grinding tools and applications, be sure to consult manufacturer directions before operating any power tool you are unfamiliar with. Although some of these tools are also offered in special versions that can be used in the presence of water to cool the blade or stone and flush debris from the cut or material surface, most grinders are not suited for wet applications.

TYPES OF GRINDERS



An interactive or media element has been excluded from this version of the text. You can view it online here:
<http://pressbooks.oer.hawaii.edu/buildingmaint/?p=82>

GRINDER ACCESSORIES



An interactive or media element has been excluded from this version of the text. You can view it online here:
<http://pressbooks.oer.hawaii.edu/buildingmaint/?p=82>

Sanding Discs for grinders usually require a hard rubber backing

plate to be attached to the grinder and for the disc to be attached to the backing plate by an adhesive or hook-and-loop fastening system, to create an orbital sander. The disc's sandpaper material composition should be selected according to the material being sanded (see Sandpaper Material Composition).

Buffing Bonnets and Wheels used for buffing metals, plastics, quarry stone and other surfaces can be made of cotton, microfiber, and other materials regularly used in hand polishing items. While bonnets are mounted to backing plates on portable grinders or buffers, buffing wheels are mounted to the arbor of stationary grinders with the arbor nut.

Sanders

Regardless of whether you are sanding by hand or using a power sander, identifying the right sanding tool and sandpaper to be used for a project can be a daunting task if you're unfamiliar with the capability of the sanding tools and the variety of sandpapers available for specific applications. Sanders can be used to form and shape a wide variety of materials and to strip or create fine finishes. When working with electric power sanders, when the tool is fitted with a variable speed option, the speed should be adjusted to a speed that creates the best cutting action in order to realize the full potential of the tool and sandpaper being used based on the material being sanded and the finish desired. As with other power tools, it is important to let the tool do the work. Too much pressure on the tool can slow or dampen the machine's action, creating less cutting action due to excessive friction or not allowing the tool to rotate or vibrate at all. Some sanders rotate in one continuous motion (orbital or track) that can leave sanding lines or swirl marks in materials. Random

orbital and oscillating sanders work in multiple pathways that create fewer lines and finer finishes.

TYPES OF SANDERS



An interactive or media element has been excluded from this version of the text. You can view it online here:
<http://pressbooks.oer.hawaii.edu/buildingmaint/?p=82>

Sand Paper



Styles

Grit is the term used to identify the coarseness (roughness) of the material on the sandpaper. Sandpapers are labeled by a number denoting their coarseness: the lower the number, the coarser the grit of the sandpaper and rougher finish; the higher the number, the finer the grit and smoother finish. The sandpaper's cutting material can consist of aluminum oxide, garnet, or silicon, and can even be used in emery cloth that resists breakdown in wet applications. For sanding items that require extensive work, it is best to start with a coarse sandpaper, graduating incrementally to finer grits to obtain the desired finish.

Material Composition

- **Garnet** quarry stone is crushed to a specified grain size and used to coat paper or cloth to make sandpaper and sanding belts commonly used for universal applications. Wears out faster than other sandpapers but is capable of creating smoother finishes.
- **Aluminum Oxide** works good for sanding wood and metal. As aluminum oxide particles flake off during use creating new sharp edges, this media lasts longer than garnet sandpaper, but does not create as smooth of a finish.
- **Silicon Carbide** is harder than garnet or aluminum oxide. This media is commonly used for metal, plastics, and fiberglass, but is a poor choice for applications with wood.
- **Emery Cloth** is a cloth material coated with a granular mineral substance normally consisting of corundum mixed with magnetite or hematite. Emery cloth is capable of holding up in

wet applications and is relied upon by plumbers to clean and etch copper pipes and fittings prior to soldering.

Surface & Application		Aluminum Oxide					Garnet				Silicon Carbide				Emery Cloth		
		40 Extra Coarse	60 Coarse	100 Medium	150 Fine	220 Extra Fine	60	100	150	220	240 Very Fine	320 Extra Fine	400 Super Fine	600 Ultra Fine	Coarse	Medium	Fine
STRIPPING	Extra Heavy	X															
	Heavy		X														
	Moderate			X													
	Light				X												
SOFT WOODS	Heavy		X				X										
	Moderate		X	X			X	X									
	Light				X	X			X								
	Finish				X	X			X								
HARD WOODS	Heavy	X	X					X									
	Moderate			X				X									
	Light				X				X								
	Finish				X	X		X	X								
FINISHES	Before Sealing				X	X		X	X								
	After Sealing				X	X		X	X			X					
	Between Coats					X		X	X			X					
	After Final Coat											X	X				
METALS	Heavy Rust Removal	X	X											X			
	Light Rust Removal		X	X											X		
	Final Sanding				X					X	X						X
	Prep for Priming									X							X
	After Priming									X	X	X	X				X
	Fine Polishing									X	X	X	X				X
WOOD SHAPING	Moderate Sanding	X	X														
	Light Sanding		X														
	Final Sanding					X				X							
PLASTICS	Heavy Material Removal	X	X														
	Light Material Removal	X	X	X	X					X							
	Finishing					X					X	X	X				

Sandpaper Selection Chart by Clifford Rutherford is licensed under CC BY 4.0



An interactive or media element has been excluded from this version of the text. You can view it online here:

<http://pressbooks.oer.hawaii.edu/buildingmaint/?p=82>

PART 3: MATHEMATICS FOR MAINTENANCE TECHS

3.1 Required Math Concepts

Numeral System and Notation

It is often said that mathematics is the language of science. If this is true, then an essential part of the language of mathematics is numbers. The earliest use of numbers occurred 100 centuries ago in the Middle East to count, or enumerate items. Farmers, cattlemen, and tradesmen used tokens, stones, or markers to signify a single quantity—a sheaf of grain, a head of livestock, or a fixed length of cloth, for example. Doing so made commerce possible, leading to improved communications and the spread of civilization.

Three to four thousand years ago, Egyptians introduced fractions. They first used them to show reciprocals. Later, they used them to represent the amount when a quantity was divided into equal parts.

But what if there were no cattle to trade or an entire crop of grain was lost in a flood? How could someone indicate the existence of nothing? From earliest times, people had thought of a “base state” while counting and used various symbols to represent this null condition. However, it was not until about the fifth century A.D. in India that zero was added to the number system and used as a numeral in calculations.

Clearly, there was also a need for numbers to represent loss or debt. In India, in the seventh century A.D., negative numbers were used as solutions to mathematical equations and commercial debts. The opposites of the counting numbers expanded the number system even further.

Because of the evolution of the number system, we can now perform complex calculations using these and other categories of real numbers. In this section, we will explore sets of numbers,

calculations with different kinds of numbers, and the use of numbers in expressions.

NUMBERS

Natural numbers

The numbers we use for counting, or enumerating items, are the natural numbers: 1, 2, 3, 4, 5, and so on. We describe them in set notation as $\{1,2,3,\dots\}$ where the ellipsis (...) indicates that the numbers continue to infinity. The natural numbers are, of course, also called the counting numbers. Any time we enumerate the members of a team, count the coins in a collection, or tally the trees in a grove, we are using the set of natural numbers.

Whole numbers

If we add zero to the counting numbers, we get the set of whole numbers.

- Counting Numbers: 1, 2, 3, ...
- Whole Numbers: 0, 1, 2, 3, ...

Integers

A set of integers adds the opposites of the natural numbers to the set of whole numbers: $\{\dots,-3,-2,-1,0,1,2,3,\dots\}$. It is useful to note that the set of integers is made up of three distinct subsets: negative integers, zero, and positive integers. In this sense, the positive integers are just the natural numbers. Another way to think about it is that the natural numbers are a subset of the integers.

negative integers	zero	positive integers
$\dots, -3, -2, -1,$	$0,$	$1, 2, 3, \dots$

FRACTIONS

Often in life, whole amounts are not exactly what we need. A baker must use a little more than a cup of milk or part of a teaspoon of sugar. Similarly a carpenter might need less than a foot of wood and a painter might use part of a gallon of paint. These people need to use numbers which are part of a whole. These numbers are very useful both in algebra and in everyday life and they are called fractions. Hence, **Fractions** are a way to represent parts of a whole. It is written $\frac{a}{b}$, where a and b are integers and $b \neq 0$. In a fraction, a is called the numerator and b is called the denominator. The denominator b represents the number of equal parts the whole has been divided into, and the numerator a represents how many parts are included. The denominator, b , cannot equal zero because division by zero is undefined.

In (Figure), the circle has been divided into three parts of equal size. Each part represents $\frac{1}{3}$ of the circle. This type of model is called a fraction circle. Other shapes, such as rectangles, can also be used to model fractions.

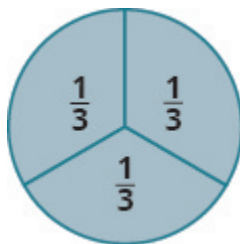

Doing the Manipulative Mathematics activity Model Fractions will help you develop a better understanding of fractions, their numerators and denominators.

What does the fraction $\frac{2}{3}$ represent? The fraction $\frac{2}{3}$ means two of three equal parts.



An interactive or media element has been excluded from this version of the text. You can view it online here: <http://pressbooks.oer.hawaii.edu/buildingmaint/?p=142>

Improper and Proper Fractions

In an improper fraction, the numerator is greater than or equal to the denominator, so its value is greater than or equal to one. Fractions such as $\frac{5}{4}$, $\frac{3}{2}$, $\frac{5}{5}$, and $\frac{7}{3}$ are called improper fractions.

When a fraction has a numerator that is smaller than the denominator, it is called a proper fraction, and its value is less than one. Fractions such as $\frac{1}{2}$, $\frac{3}{7}$, and $\frac{11}{18}$ are proper fractions.

Equivalent Fractions

Equivalent fractions are fractions that have the same value. For example, the fractions $\frac{6}{6}$ and $\frac{8}{8}$ have the same value, 1. Figure shows two images: a single pizza on the left, cut into two equal pieces, and a second pizza of the same size, cut into eight pieces on the right. This

is a way to show that $\frac{1}{2}$ is equivalent to $\frac{4}{8}$. In other words, they are equivalent fractions.

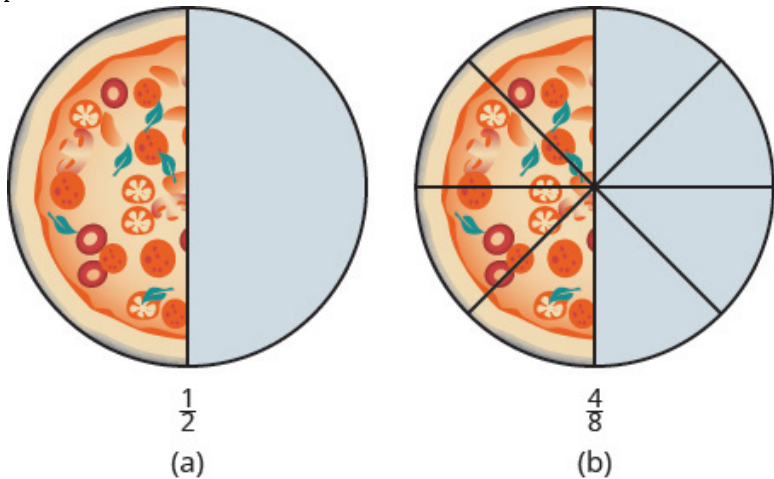

Figure #. Since the same amount of each pizza is shaded, we see that $\frac{1}{2}$ is equivalent to $\frac{4}{8}$.

Add or Subtract Fractions

To add or subtract fractions, they must have a common denominator. If the fractions have the same denominator, we just add the numerators and place the sum over the common denominator. If the fractions have different denominators, what do we need to do?

First, we will use fraction tiles to model finding the common denominator of $\frac{1}{2}$ and $\frac{1}{3}$.

We'll start with one $\frac{1}{2}$ tile and $\frac{1}{3}$ tile. We want to find a common fraction tile that we can use to match *both* $\frac{1}{2}$ and $\frac{1}{3}$ exactly.

If we try the $\frac{1}{4}$ pieces, 2 of them exactly match the $\frac{1}{2}$ piece, but they do not exactly match the $\frac{1}{3}$ piece.



If we try the $\frac{1}{5}$ pieces, they do not exactly cover the $\frac{1}{2}$ piece or the $\frac{1}{3}$ piece.

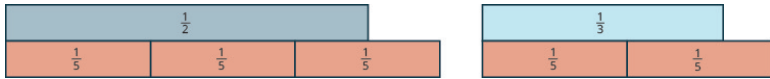

If we try the $\frac{1}{6}$ pieces, we see that exactly 3 of them cover the $\frac{1}{2}$ piece, and exactly 2 of them cover the $\frac{1}{3}$ piece.

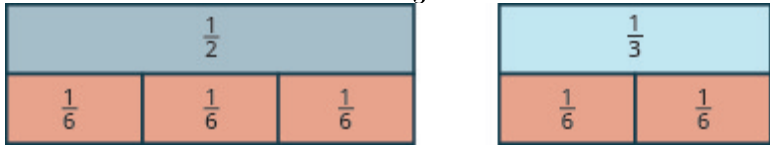

If we were to try the $\frac{1}{12}$ pieces, they would also work.

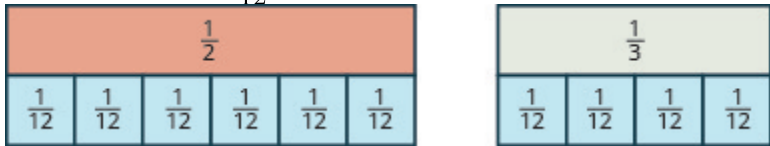

Even smaller tiles, such as $\frac{1}{24}$ and $\frac{1}{48}$, would also exactly cover the $\frac{1}{2}$ piece and the $\frac{1}{3}$ piece.

The denominator of the largest piece that covers both fractions is the least common denominator (LCD) of the two fractions. So, the least common denominator of $\frac{1}{2}$ and $\frac{1}{3}$ is 6.

Notice that all of the tiles that cover $\frac{1}{2}$ and $\frac{1}{3}$ have something in common: Their denominators are common multiples of 2 and 3, the denominators of $\frac{1}{2}$ and $\frac{1}{3}$. The least common multiple (LCM) of the denominators is 6, and so we say that 6 is the least common denominator (LCD) of the fractions $\frac{1}{2}$ and $\frac{1}{3}$. Therefore, the least common denominator (LCD) of two fractions is the least common multiple (LCM) of their denominators.

To find the LCD of two fractions, we will find the LCM of their denominators. We follow the procedure we used earlier to find the LCM of two numbers. We only use the denominators of the fractions, not the numerators, when finding the LCD.

Find the LCD for the fractions $\frac{7}{12}$ and $\frac{5}{18}$.

Solution

Factor each denominator into its primes.

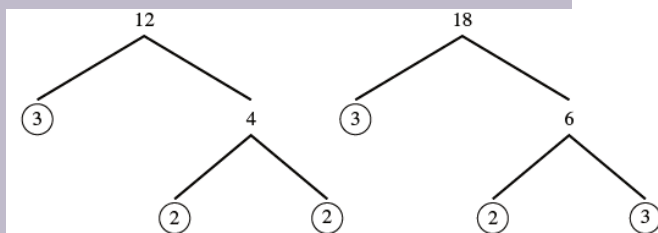

List the primes of 12 and the primes of 18 lining them up in columns when possible.

$$\begin{array}{l} 12 = 2 \cdot 2 \cdot 3 \\ 18 = 2 \cdot 3 \cdot 3 \end{array}$$

Bring down the columns.

$$\begin{array}{l} 12 = 2 \cdot 2 \cdot 3 \\ 18 = 2 \cdot 3 \cdot 3 \\ \hline \text{LCM} = 2 \cdot 2 \cdot 3 \cdot 3 \end{array}$$

Multiply the factors. The product is the LCM.

$$\text{LCM} = 36$$

The LCM of 12 and 18 is 36, so the LCD of $\frac{7}{12}$ and $\frac{5}{18}$ is 36.

LCD of $\frac{7}{12}$ and $\frac{5}{18}$ is 36.

Fractions addition and subtraction trick – do them the fast way!



An interactive or media element has been excluded from this version of the text. You can view it online here:
<http://pressbooks.oer.hawaii.edu/buildingmaint/?p=142>

Multiply Fractions

When we multiplied fractions, we just multiplied the numerators and multiplied the denominators right straight across.

A model may help you understand multiplication of fractions. We will use fraction tiles to model $\frac{1}{2} \cdot \frac{3}{4}$. To multiply $\frac{1}{2}$ and $\frac{3}{4}$, think $\frac{1}{2}$ of $\frac{3}{4}$.

Start with fraction tiles for three-fourths. To find one-half of three-fourths, we need to divide them into two equal groups. Since we cannot divide the three $\frac{1}{4}$ tiles evenly into two parts, we exchange them for smaller tiles.

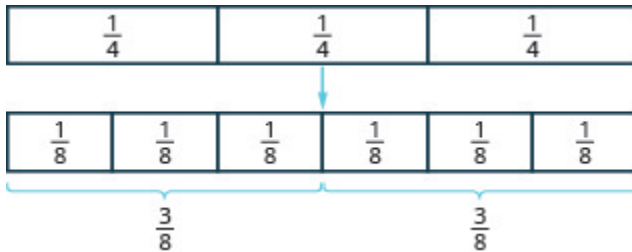

We see $\frac{6}{8}$ is equivalent to $\frac{3}{4}$. Taking half of the six $\frac{1}{8}$ tiles gives us three $\frac{1}{8}$ tiles, which is $\frac{3}{8}$.

$$\text{Therefore, } \frac{1}{2} \cdot \frac{3}{4} = \frac{3}{8}$$

When multiplying fractions, the properties of positive and negative numbers still apply. It is a good idea to determine the sign of the

product as the first step. In Example 4.26 we will multiply two negatives, so the product will be positive.

Multiply, and write the answer in simplified form:
 $-\frac{5}{8} \left(-\frac{2}{3}\right)$.

Solution

	$-\frac{5}{8} \left(-\frac{2}{3}\right)$
The signs are the same, so the product is positive. Multiply the numerators, multiply the denominators.	$\frac{5 \cdot 2}{8 \cdot 3}$
Simplify.	$\frac{10}{24}$
Look for common factors in the numerator and denominator. Rewrite showing common factors.	$\frac{5 \cdot \cancel{2}}{12 \cdot \cancel{2}}$
Remove common factors.	$\frac{5}{12}$

Another way to find this product involves removing common factors earlier.

	$-\frac{5}{8} \left(-\frac{2}{3}\right)$
Determine the sign of the product. Multiply.	$\frac{5 \cdot 2}{8 \cdot 3}$
Show common factors and then remove them.	$\frac{5 \cdot \cancel{2}}{4 \cdot \cancel{2} \cdot 3}$
Multiply remaining factors.	$\frac{5}{12}$

We get the same result.

Multiplying two fractions: Example



An interactive or media element has been excluded from this version of the text. You can view it online here:
<http://pressbooks.oer.hawaii.edu/buildingmaint/?p=142>

Divide Fractions

Now that we know how to multiply fractions, we are almost ready to divide. Before we can do that, that we need some vocabulary.

The reciprocal of a fraction is found by inverting the fraction, placing the numerator in the denominator and the denominator in the numerator. The reciprocal of $\frac{2}{3}$ is $\frac{3}{2}$.

Notice that $\frac{2}{3} \cdot \frac{3}{2} = 1$. A number and its reciprocal multiply to 1.

To get a product of positive 1 when multiplying two numbers, the numbers must have the same sign. So reciprocals must have the same sign.

The reciprocal of $-\frac{10}{7}$ is $-\frac{7}{10}$, since $-\frac{10}{7} \left(\frac{7}{10}\right) = 1$.

Dividing Fractions: Example



An interactive or media element has been excluded from this version of the text. You can

view it online here:

<http://pressbooks.oer.hawaii.edu/buildingmaint/?p=142>

DECIMALS

You probably already know quite a bit about decimals based on your experience with money. Suppose you buy a sandwich and a bottle of water for lunch. If the sandwich costs 3.45 , the bottle of water costs 1.25 , and the total sales tax is 0.33 , what is the total cost of your lunch?

\$3.45	Sandwich
\$1.25	Water
+ \$0.33	Tax
<hr/>	
\$5.03	Total

The total is 5.03 . Suppose you pay with a 5 bill and 3 pennies. Should you wait for change? No, 5 and 3 pennies is the same as 5.03 .

Because 100 pennies = 1, each penny is worth $\frac{1}{100}$ of a dollar. We write the value of one penny as 0.01 , since $0.01 = \frac{1}{100}$.

Decimals are in fact another way of writing fractions whose denominators are powers of 10.

Just as the counting numbers are based on powers of ten, decimals are based on powers of ten. (Figure) shows the counting numbers.

Counting number	Name
1	One
$10 = 10$	Ten
$1010 = 100$	One hundred
$101010 = 1000$	One thousand
$10101010 = 10,000$	Ten thousand

How are decimals related to fractions? (Figure) shows the relation.

Decimal	Fraction	Name
0.1	$\frac{1}{10}$	One tenth
0.01	$\frac{1}{100}$	One hundredth
0.001	$\frac{1}{1,000}$	One thousandth
0.0001	$\frac{1}{10,000}$	One ten-thousandth

Add and Subtract Decimals

Let's take one more look at the lunch order from the start of Decimals, this time noticing how the numbers were added together.

\$3.45	Sandwich
\$1.25	Water
+ \$0.33	Tax
<hr/>	
\$5.03	Total

All three items (sandwich, water, tax) were priced in dollars and cents, so we lined up the dollars under the dollars and the cents under the cents, with the decimal points lined up between them. Then we just added each column, as if we were adding whole

numbers. By lining up decimals this way, we can add or subtract the corresponding place values just as we did with whole numbers.

Add or subtract decimals.

1. Write the numbers vertically so the decimal points line up.
2. Use zeros as place holders, as needed.
3. Add or subtract the numbers as if they were whole numbers.
Then place the decimal in the answer under the decimal points in the given numbers.

Multiply Decimals

Multiplying decimals is very much like multiplying whole numbers—we just have to determine where to place the decimal point. The procedure for multiplying decimals will make sense if we first review multiplying fractions.

Do you remember how to multiply fractions? To multiply fractions, you multiply the numerators and then multiply the denominators.

So let's see what we would get as the product of decimals by converting them to fractions first. We will do two examples side-by-side in (Figure). Look for a pattern.

	A	B
	$(0.3)(0.7)$	$(0.2)(0.46)$
Convert to fractions.	$\left(\frac{3}{10}\right)\left(\frac{7}{10}\right)$	$\left(\frac{2}{10}\right)\left(\frac{46}{100}\right)$
Multiply.	$\frac{21}{100}$	$\frac{92}{1000}$
Convert back to decimals.	0.21	0.092

There is a pattern that we can use. In A, we multiplied two numbers that each had one decimal place, and the product had two decimal places. In B, we multiplied a number with one decimal place by a

number with two decimal places, and the product had three decimal places.

How many decimal places would you expect for the product of $(0.01)(0.004)$? If you said “five”, you recognized the pattern. When we multiply two numbers with decimals, we count all the decimal places in the factors—in this case two plus three—to get the number of decimal places in the product—in this case five.

$$\begin{array}{ccc} (0.01) & (0.004) & = 0.00004 \\ \underbrace{\hspace{1.5em}} & \underbrace{\hspace{1.5em}} & \underbrace{\hspace{1.5em}} \\ 2 \text{ places} & 3 \text{ places} & 5 \text{ places} \end{array}$$

$$\left(\frac{1}{100}\right)\left(\frac{4}{1000}\right) = \frac{4}{100,000}$$

Once we know how to determine the number of digits after the decimal point, we can multiply decimal numbers without converting them to fractions first. The number of decimal places in the product is the sum of the number of decimal places in the factors.

The rules for multiplying positive and negative numbers apply to decimals, too, of course.

When multiplying two numbers,

- if their signs are the same, the product is positive.
- if their signs are different, the product is negative.

When you multiply signed decimals, first determine the sign of the product and then multiply as if the numbers were both positive. Finally, write the product with the appropriate sign.

Multiply decimal numbers

1. Determine the sign of the product.

- Write the numbers in vertical format, lining up the numbers on the right.
- Multiply the numbers as if they were whole numbers, temporarily ignoring the decimal points.
- Place the decimal point. The number of decimal places in the product is the sum of the number of decimal places in the factors. If needed, use zeros as placeholders.
- Write the product with the appropriate sign.

Multiplying Decimals: Example



An interactive or media element has been excluded from this version of the text. You can view it online here:
<http://pressbooks.oer.hawaii.edu/buildingmaint/?p=142>

Multiply by Powers of 10

In many fields, especially in the sciences, it is common to multiply decimals by powers of 10. Let's see what happens when we multiply 1.9436 by some powers of 10.

$1.9436(10)$ $\begin{array}{r} 1.9436 \\ \times 10 \\ \hline 19.4360 \end{array}$	$1.9436(100)$ $\begin{array}{r} 1.9436 \\ \times 100 \\ \hline 194.3600 \end{array}$	$1.9436(1000)$ $\begin{array}{r} 1.9436 \\ \times 1000 \\ \hline 1943.6000 \end{array}$
---	--	---

Look at the results without the final zeros. Do you notice a pattern?

$$1.9436 (10) = 19.436$$

$$1.9436 (100) = 194.36$$

$$1.9436 (1000) = 1943.6$$

The number of places that the decimal point moved is the same as the number of zeros in the power of ten. (Figure) summarizes the results.

Multiply by	Number of zeros	Number of places decimal point moves
10	1	1 place to the right
100	2	2 places to the right
1,000	3	3 places to the right
10,000	4	4 places to the right

We can use this pattern as a shortcut to multiply by powers of ten instead of multiplying using the vertical format. We can count the zeros in the power of 10 and then move the decimal point that same of places to the right.

So, for example, to multiply 45.86 by 100, move the decimal point 2 places to the right.

$$45.86 \times 100 = 4586.$$



Sometimes when we need to move the decimal point, there are not enough decimal places. In that case, we use zeros as placeholders. For example, let's multiply 2.4 by 100. We need to move the decimal point 2 places to the right. Since there is only one digit to the right of the decimal point, we must write a 0 in the hundredths place.

$$2.4 \times 100 = 240.$$



Multiply a decimal by a power of 10.

1. Move the decimal point to the right the same number of places as the number of zeros in the power of 10.
2. Write zeros at the end of the number as placeholders if needed.

Divide Decimals

Just as with multiplication, division of decimals is very much like dividing whole numbers. We just have to figure out where the decimal point must be placed.

To understand decimal division, let's consider the multiplication problem

$$(0.2)(4) = 0.8$$

Remember, a multiplication problem can be rephrased as a division problem. So we can write

$$0.84 = 0.2$$

We can think of this as "If we divide 8 tenths into four groups, how many are in each group?" (Figure) shows that there are four groups of two-tenths in eight-tenths. So $0.84 = 0.2$.

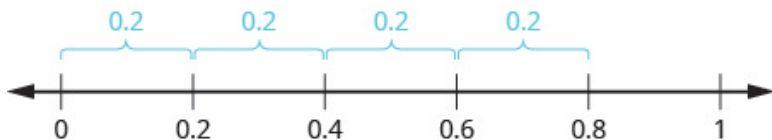

Using long division notation, we would write

$$\begin{array}{r} 0.2 \\ 4 \overline{)0.8} \end{array}$$

Notice that the decimal point in the quotient is directly above the decimal point in the dividend.

To divide a decimal by a whole number, we place the decimal point

in the quotient above the decimal point in the dividend and then divide as usual. Sometimes we need to use extra zeros at the end of the dividend to keep dividing until there is no remainder.

Divide a decimal by a whole number.

1. Write as long division, placing the decimal point in the quotient above the decimal point in the dividend.
2. Divide as usual.

Divide a Decimal by Another Decimal

So far, we have divided a decimal by a whole number. What happens when we divide a decimal by another decimal? Let's look at the same multiplication problem we looked at earlier, but in a different way.

$$(0.2)(4) = 0.8$$

Remember, again, that a multiplication problem can be rephrased as a division problem. This time we ask, "How many times does 0.2 go into 0.8?" Because $(0.2)(4) = 0.8$, we can say that 0.2 goes into 0.8 four times. This means that 0.8 divided by 0.2 is 4.

$$0.8 \div 0.2 = 4$$

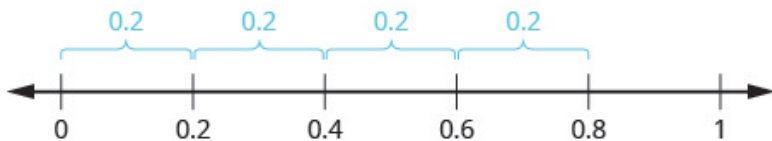

We would get the same answer, 4, if we divide 8 by 2, both whole numbers. Why is this so? Let's think about the division problem as a fraction.

$$\frac{0.8}{0.2}$$

$$\frac{(0.8)10}{(0.2)10}$$

$$\frac{8}{2}$$

$$4$$

We multiplied the numerator and denominator by 10 and ended up just dividing 8 by 4. To divide decimals, we multiply both the numerator and denominator by the same power of 10 to make the denominator a whole number. Because of the Equivalent Fractions Property, we haven't changed the value of the fraction. The effect is to move the decimal points in the numerator and denominator the same number of places to the right.

We use the rules for dividing positive and negative numbers with decimals, too. When dividing signed decimals, first determine the sign of the quotient and then divide as if the numbers were both positive. Finally, write the quotient with the appropriate sign.

It may help to review the vocabulary for division:

$$\begin{array}{ccccccc} a & \div & b & & \frac{a \text{ dividend}}{b \text{ divisor}} & & \begin{array}{r} b \\ \overline{) a} \end{array} \\ \text{dividend} & & \text{divisor} & & & & \text{divisor} \quad \text{dividend} \end{array}$$

Divide decimal numbers.

1. Determine the sign of the quotient.
2. Make the divisor a whole number by moving the decimal point all the way to the right. Move the decimal point in the dividend the same number of places to the right, writing zeros as needed.
3. Divide. Place the decimal point in the quotient above the decimal point in the dividend.
4. Write the quotient with the appropriate sign.

Dividing Decimals – Example



An interactive or media element has been excluded from this version of the text. You can view it online here:
<http://pressbooks.oer.hawaii.edu/buildingmaint/?p=142>

EXPONENTS

An exponent indicates repeated multiplication of the same quantity. For example, 2^4 means to multiply four factors of 2, so 2^4 means $2 \cdot 2 \cdot 2 \cdot 2$. This format is known as exponential notation.

Exponential Notation

a^m means multiply m factors of a

$$a^m = \underbrace{a \cdot a \cdot a \cdot \dots \cdot a}_{m \text{ factors}}$$

This is read a to the m th power.

In the expression a^m , the exponent tells us how many times we use the base a as a factor.

$$7^3$$
$$\underbrace{7 \cdot 7 \cdot 7}_{3 \text{ factors}}$$

$$(-8)^5$$
$$\underbrace{(-8)(-8)(-8)(-8)(-8)}_{5 \text{ factors}}$$

Square

Do you know why we use the word *square*? If we construct a square with three tiles on each side, the total number of tiles would be nine.



This is why we say that the square of three is nine.

$$3^2 = 9$$

What happens when you square a negative number?

$$(-8)^2 = (-8)(-8) = 64$$

When we multiply two negative numbers, the product is always positive. So the square of a negative number is always positive.

Cube

Square Roots

Sometimes we will need to look at the relationship between numbers and their squares in reverse. Because $10^2=100$, we say 100 is the square of 10. We can also say that 10 is a square root of 100.

Square Root of a Number

A number whose square is m is called a square root of m .

If $n^2=m$, then n is a square root of m .

Notice $(-10)^2=100$ also, so -10 is also a square root of 100 . Therefore, both 10 and -10 are square roots of 100 .

So, every positive number has two square roots: one positive and one negative.

What if we only want the positive square root of a positive number? The *radical sign*, $\sqrt{\quad}$, stands for the positive square root. The positive square root is also called the principal square root.

Square Root Notation

\sqrt{m} is read as “the square root of m .”

If $m=n^2$, then $n = \sqrt{m}$ for $n \geq 0$. If $m = n^2$, then $n = -\sqrt{m}$ for $n \leq 0$.



We can also use the radical sign for the square root of zero. Because $0^2=0$, $\sqrt{0}=0$. Notice that zero has only one square root.

$\sqrt{1}$	$\sqrt{4}$	$\sqrt{9}$	$\sqrt{16}$	$\sqrt{25}$	$\sqrt{36}$	$\sqrt{49}$	$\sqrt{64}$	$\sqrt{81}$	$\sqrt{100}$	$\sqrt{121}$	$\sqrt{144}$	$\sqrt{169}$	$\sqrt{196}$	$\sqrt{225}$
1	2	3	4	5	6	7	8	9	10	11	12	13	14	15

Square Root of a Negative Number

Can we simplify $\sqrt{-25}$? Is there a number whose square is -25 ?

$$()^2 = -25?$$

None of the numbers that we have dealt with so far have a square

that is -25 . Why? Any positive number squared is positive, and any negative number squared is also positive. There is no real number equal to -25 . If we are asked to find the square root of any negative number, we say that the solution is not a real number.

Estimate Square Roots (done)

So far we have only worked with square roots of perfect squares. The square roots of other numbers are not whole numbers.

Number	Square root
4	$\sqrt{4} = 2$
5	$\sqrt{5}$
6	$\sqrt{6}$
7	$\sqrt{7}$
8	$\sqrt{8}$
9	$\sqrt{9} = 3$

We might conclude that the square roots of numbers between 4 and 9 will be between 2 and 3, and they will not be whole numbers. Based on the pattern in the table above, we could say that $\sqrt{5}$ is between 2 and 3. Using inequality symbols, we write $2 < \sqrt{5} < 3$

Approximate Square Roots with a Calculator

There are mathematical methods to approximate square roots, but it is much more convenient to use a calculator to find square roots. Find the $\sqrt{\quad}$ or \sqrt{x} key on your calculator. You will to use this key

to approximate square roots. When you use your calculator to find the square root of a number that is not a perfect square, the answer that you see is not the exact number. It is an approximation, to the number of digits shown on your calculator's display. The symbol for an approximation is \approx and it is read *approximately*.

Suppose your calculator has a 10-digit display. Using it to find the square root of 5 will give 2.236067977. This is the approximate square root of 5. When we report the answer, we should use the "approximately equal to" sign instead of an equal sign.

$$\sqrt{5} \approx 2.2360679785$$

You will seldom use this many digits for applications in algebra. So, if you wanted to round $\sqrt{5}$ to two decimal places, you would write

$$\sqrt{5} \approx 2.24$$

How do we know these values are approximations and not the exact values? Look at what happens when we square them.

$$2.236067978^2 = 5.000000002$$

$$2.24^2 = 5.0176$$

The squares are close, but not exactly equal, to 5.

Introduction to Exponents



An interactive or media element has been excluded from this version of the text. You can view it online here:
<http://pressbooks.oer.hawaii.edu/buildingmaint/?p=142>

RATIOS

When you apply for a mortgage, the loan officer will compare your total debt to your total income to decide if you qualify for the loan. This comparison is called the debt-to-income ratio. A ratio compares two quantities that are measured with the same unit. If we compare a and b , the ratio is written as a to b , $\frac{a}{b}$, or $a:b$.

Ratios Involving Decimals

We will often work with ratios of decimals, especially when we have ratios involving money. In these cases, we can eliminate the decimals by using the Equivalent Fractions Property to convert the ratio to a fraction with whole numbers in the numerator and denominator.

For example, consider the ratio 0.8 to 0.05. We can write it as a fraction with decimals and then multiply the numerator and denominator by 100 to eliminate the decimals.

$$\begin{array}{r} \frac{0.8}{0.05} \\ \frac{(0.8)100}{(0.05)100} \\ \frac{80}{5} \end{array}$$

Do you see a shortcut to find the equivalent fraction? Notice that $0.8 = \frac{8}{10}$ and $0.05 = \frac{5}{100}$. The least common denominator of $\frac{8}{10}$ and $\frac{5}{100}$ is 100. By multiplying the numerator and denominator of $\frac{0.8}{0.05}$ by 100, we 'moved' the decimal two places to the right to get the equivalent fraction with no decimals. Now that we understand

the math behind the process, we can find the fraction with no decimals like this:

$$\begin{array}{r} 0.80 \\ \downarrow \downarrow \\ \hline 0.05 \\ \downarrow \downarrow \end{array}$$

“Move” the decimal 2 places. $\frac{80}{5}$

Simplify. $\frac{16}{1}$

You do not have to write out every step when you multiply the numerator and denominator by powers of ten. As long as you move both decimal places the same number of places, the ratio will remain the same.



An interactive or media element has been excluded from this version of the text. You can view it online here:
<http://pressbooks.oer.hawaii.edu/buildingmaint/?p=142>

Perimeter, Area, and Volume

PERIMETER AND AREA

The **perimeter** is a measure of the distance around a figure. The **area** is a measure of the surface covered by a figure.



An interactive or media element has been excluded from this version of the text. You can view it online here:
<http://pressbooks.oer.hawaii.edu/buildingmaint/?p=142>

Square

(Figure) shows a square tile that is 1 inch on each side. If an ant walked around the edge of the tile, it would walk 4 inches. This distance is the perimeter of the tile. Since the tile is a square that is 1 inch on each side, its area is one square inch. The area of a shape is measured by determining how many square units cover the shape.

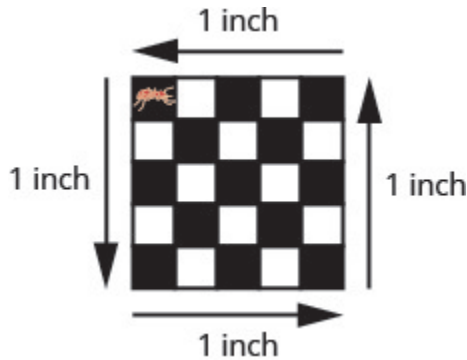

Figure #. Perimeter = 4 inches Area = 1 square inch

When the ant walks completely around the tile on its edge, it is tracing the perimeter of the tile. The area of the tile is 1 square inch.

Rectangle

A rectangle has four sides and four right angles. The opposite sides of a rectangle are the same length. We refer to one side of the rectangle as the length, L , and the adjacent side as the width, W . See (Figure).

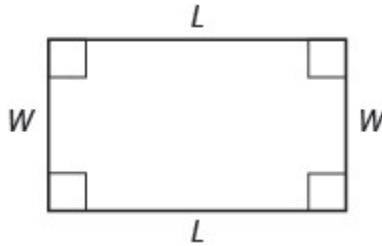

Figure #. A rectangle has four sides, and four right angles. The sides are labeled L for length and W for width.

The perimeter, P , of the rectangle is the distance around the rectangle. If you started at one corner and walked around the rectangle, you would walk $L+W+L+W$ units, or two lengths and two widths. The perimeter then is

$$P=L+W+L+W$$

or

$$P=2L+2W$$

What about the area of a rectangle? Remember the rectangular rug from the beginning of this section. It was 2 feet long by 3 feet wide, and its area was 6 square feet. See (Figure). Since $A=2\cdot 3$, we see that the area, A , is the length, L , times the width, W , so the area of a rectangle is $A=L\cdot W$.

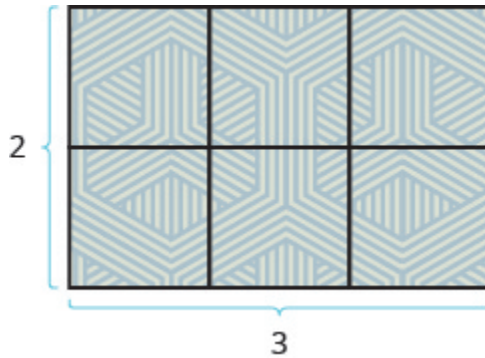

Figure #. The area of this rectangular rug is 6 square feet, its length times its width.

Triangle

We now know how to find the area of a rectangle. We can use this fact to help us visualize the formula for the area of a triangle. In the rectangle in (Figure), we've labeled the length b and the width h , so it's area is bh .

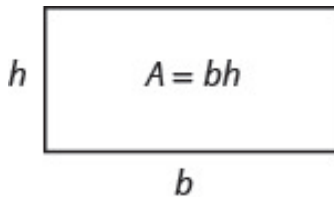

Figure #. The area of a rectangle is the base, b , times the height, h .

We can divide this rectangle into two congruent triangles (Figure). Triangles that are congruent have identical side lengths and angles, and so their areas are equal. The area of each triangle is one-half the area of the rectangle, or $\frac{1}{2}bh$. This example helps us see why the formula for the area of a triangle is $A = \frac{1}{2}bh$.

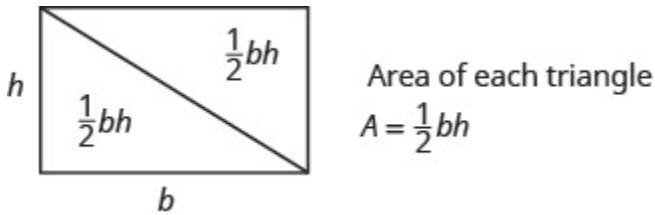

Figure #. A rectangle can be divided into two triangles of equal area. The area of each triangle is one-half the area of the rectangle.

The formula for the area of a triangle is $A = \frac{1}{2}bh$, where b is the base and h is the height.

To find the area of the triangle, you need to know its base and height. The base is the length of one side of the triangle, usually the side at the bottom. The height is the length of the line that connects the base to the opposite vertex, and makes a 90° angle with the base. (Figure) shows three triangles with the base and height of each marked.

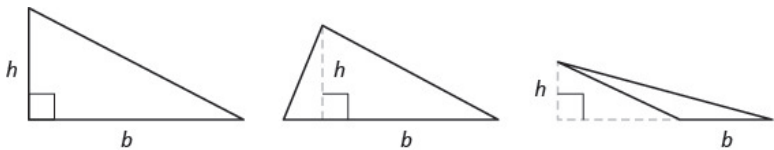

Figure #. The height h of a triangle is the length of a line segment that connects the the base to the opposite vertex and makes a 90° angle with the base.

Isosceles and Equilateral Triangles

Besides the right triangle, some other triangles have special names. A triangle with two sides of equal length is called an isosceles triangle. A triangle that has three sides of equal length is called an equilateral triangle. (Figure) shows both types of triangles.

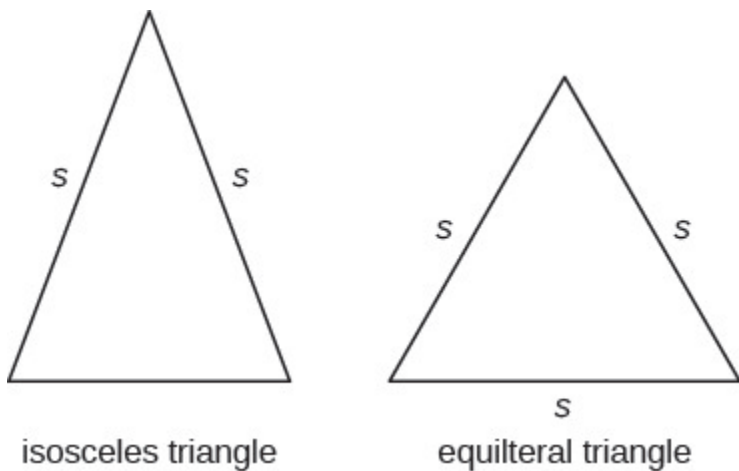

Figure #. In an isosceles triangle, two sides have the same length, and the third side is the base. In an equilateral triangle, all three sides have the same length.

Isosceles and Equilateral Triangles

- An **isosceles** triangle has two sides the same length.
- An **equilateral** triangle has three sides of equal length.

Trapezoid

A trapezoid is four-sided figure, a *quadrilateral*, with two sides that are parallel and two sides that are not. The parallel sides are called the bases. We call the length of the smaller base b , and the length of the bigger base B . The height, h , of a trapezoid is the distance between the two bases as shown in (Figure).

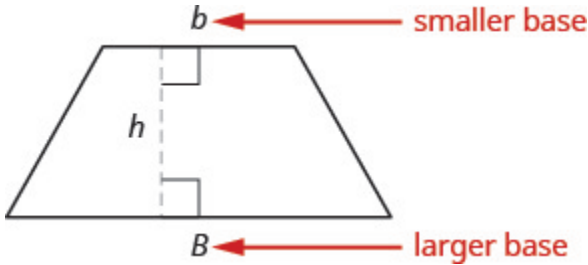

Figure #. A trapezoid has a larger base, B , and a smaller base, b . The height h is the distance between the bases.

The formula for the area of a trapezoid is:

$$\text{Area}_{\text{trapezoid}} = \frac{1}{2}h(b+B)$$

Splitting the trapezoid into two triangles may help us understand the formula. The area of the trapezoid is the sum of the areas of the two triangles. See (Figure).

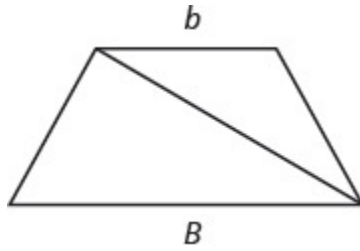
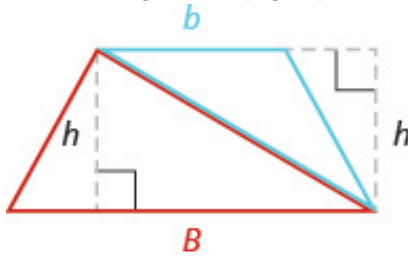

Figure #. Splitting a trapezoid into two triangles may help you understand the formula for its area.

The height of the trapezoid is also the height of each of the two triangles. See (Figure).



The formula for the area of a trapezoid is

$$\text{Area}_{\text{trapezoid}} = \frac{1}{2} h(b + B)$$

If we distribute, we get,

$$\text{Area}_{\text{trapezoid}} = \frac{1}{2}bh + \frac{1}{2}Bh$$

$$\text{Area}_{\text{trapezoid}} = A_{\text{blue}\Delta} + A_{\text{red}\Delta}$$

Circle

The properties of circles have been studied for over 2,000 years. All circles have exactly the same shape, but their sizes are affected by the length of the radius, a line segment from the center to any point on the circle. A line segment that passes through a circle's center connecting two points on the circle is called a diameter. The diameter is twice as long as the radius. See (Figure).

The size of a circle can be measured in two ways. The distance around a circle is called its circumference.

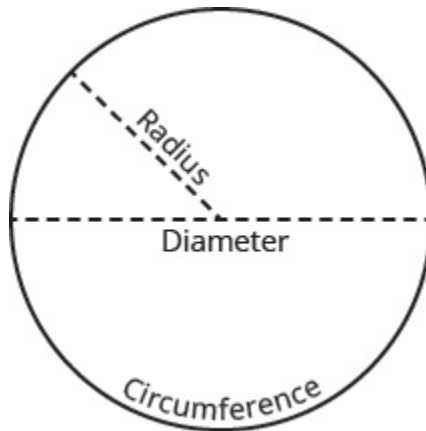

Archimedes discovered that for circles of all different sizes, dividing the circumference by the diameter always gives the same number. The value of this number is pi, symbolized by Greek letter π (pronounced pie). However, the exact value of π cannot be calculated since the decimal never ends or repeats (we will learn more about numbers like this in The Properties of Real Numbers.)

If we want the exact circumference or area of a circle, we leave the symbol π in the answer. We can get an approximate answer by substituting 3.14 as the value of π . We use the symbol \approx to show that the result is approximate, not exact.

Properties of Circles

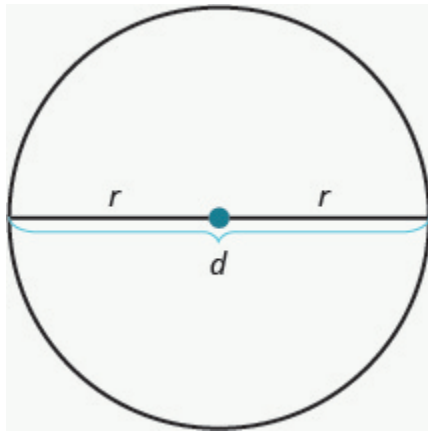

r is the length of the radius.

d is the length of the diameter.

The circumference is $2\pi r$. $C = 2\pi r$

The area is πr^2 . $A = \pi r^2$

Since the diameter is twice the radius, another way to find the circumference is to use the formula $C = \pi d$.

Suppose we want to find the exact area of a circle of radius 10 inches. To calculate the area, we would evaluate the formula for the area when $r = 10$ inches and leave the answer in terms of π .

$$A = r^2$$

$$A = (10^2)$$

$$A = \pi 100$$

We write π after the 100. So the exact value of the area is $A = 100$ square inches.

To approximate the area, we would substitute $\pi \approx 3.14$.

$$A \approx 100$$

$$\approx 1003.14$$

$$\approx 314 \text{ square inches}$$

Remember to use square units, such as square inches, when you calculate the area.

Sphere

A sphere is the shape of a basketball, like a three-dimensional circle. Just like a circle, the size of a sphere is determined by its radius, which is the distance from the center of the sphere to any point on its surface. The formulas for the volume and surface area of a sphere are given below.

Showing where these formulas come from, like we did for a rectangular solid, is beyond the scope of this course. We will approximate π with 3.14.

Volume and Surface Area of a Sphere

For a sphere with radius r :



Cube or Rectangle

A cube is a rectangular solid whose length, width, and height are equal. See Volume and Surface Area of a Cube, below. Substituting, s for the length, width and height into the formulas for volume and surface area of a rectangular solid, we get:

$$V=LWH \quad S=2LH+2LW+2WH$$

$$V=s \cdot s \cdot s \quad S=2s \cdot s+2s \cdot s+2s \cdot s$$

$$V=s^3 \quad S=2s^2+2s^2+2s^2$$

$$S=6s^2$$

So for a cube, the formulas for volume and surface area are $V=s^3$ and $S=6s^2$.

Volume and Surface Area of a Cube

For any cube with sides of length s ,

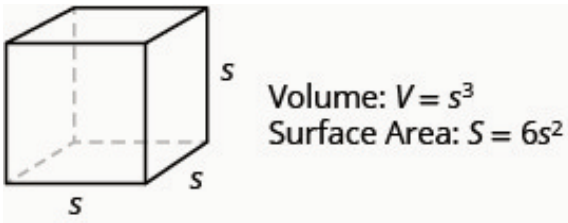

Cylinder

If you have ever seen a can of soda, you know what a cylinder looks like. A cylinder is a solid figure with two parallel circles of the same size at the top and bottom. The top and bottom of a cylinder are called the bases. The height h of a cylinder is the distance between the two bases. For all the cylinders we will work with here, the sides and the height, h , will be perpendicular to the bases.

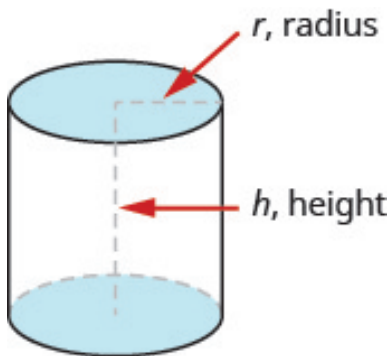

Figure #. A cylinder has two circular bases of equal size. The height is the distance between the bases.

Rectangular solids and cylinders are somewhat similar because they both have two bases and a height. The formula for the volume of a rectangular solid, $V=Bh$, can also be used to find the volume of a cylinder.

For the rectangular solid, the area of the base, B , is the area of the rectangular base, length \times width. For a cylinder, the area of the base, B , is the area of its circular base, πr^2 . (Figure) compares how the formula $V=Bh$ is used for rectangular solids and cylinders.

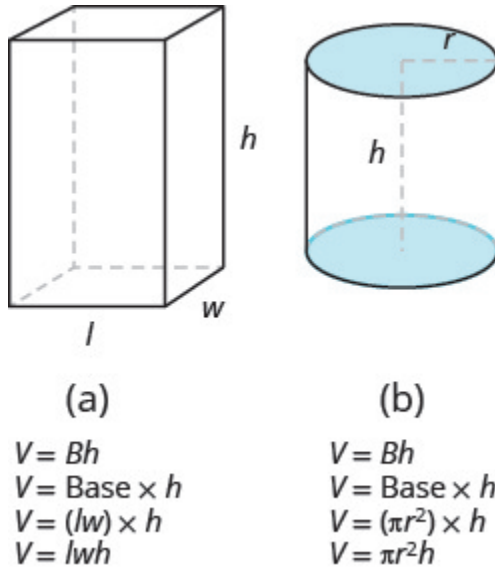

Figure #. Seeing how a cylinder is similar to a rectangular solid may make it easier to understand the formula for the volume of a cylinder.

To understand the formula for the surface area of a cylinder, think of a can of vegetables. It has three surfaces: the top, the bottom, and the piece that forms the sides of the can. If you carefully cut the label off the side of the can and unroll it, you will see that it is a rectangle. See (Figure).

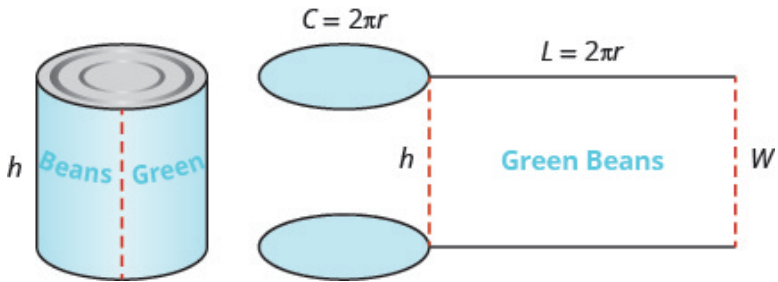

Figure #. By cutting and unrolling the label of a can of vegetables, we can see that the surface of a cylinder is a rectangle. The length of the rectangle is the circumference of the cylinder's base, and the width is the height of the cylinder.

The distance around the edge of the can is the circumference of the cylinder's base it is also the length L of the rectangular label. The height of the cylinder is the width W of the rectangular label. So the area of the label can be represented as

$$A = L \cdot W$$

$$A = 2\pi r \cdot h$$

The diagram shows the substitution of $L = 2\pi r$ and $W = h$ into the area formula. A blue arrow points from L in the first equation to $2\pi r$ in the second, and a red arrow points from W to h .

To find the total surface area of the cylinder, we add the areas of the two circles to the area of the rectangle.



$$S = A_{\text{top circle}} + A_{\text{bottom circle}} + A_{\text{rectangle}}$$

$$S = \underbrace{\pi r^2 + \pi r^2}_{2\pi r^2} + 2\pi r \cdot h$$

$$S = 2 \cdot \pi r^2 + 2\pi r h$$

$$S = 2\pi r^2 + 2\pi r h$$

The surface area of a cylinder with radius r and height h , is $S=2\pi r^2+2\pi r h$

Volume and Surface Area of a Cylinder

For a cylinder with radius r and height h :

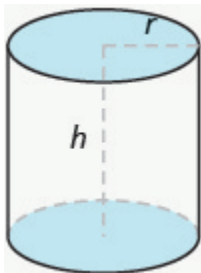

$$\text{Volume: } V = \pi r^2 h \text{ or } V = Bh$$

$$\text{Surface Area: } S = 2\pi r^2 + 2\pi r h$$

Cone

The first image that many of us have when we hear the word 'cone' is

an ice cream cone. There are many other applications of cones (but most are not as tasty as ice cream cones). In this section, we will see how to find the volume of a cone.

In geometry, a cone is a solid figure with one circular base and a vertex. The height of a cone is the distance between its base and the vertex. The cones that we will look at in this section will always have the height perpendicular to the base. See (Figure).

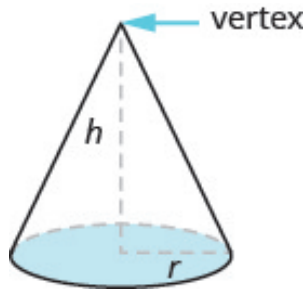

Figure #. The height of a cone is the distance between its base and the vertex.

Earlier in this section, we saw that the volume of a cylinder is $V = \pi r^2 h$. We can think of a cone as part of a cylinder. (Figure) shows a cone placed inside a cylinder with the same height and same base. If we compare the volume of the cone and the cylinder, we can see that the volume of the cone is less than that of the cylinder.

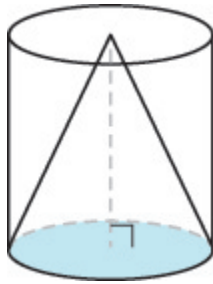

Figure #. The volume of a cone is less than the volume of a cylinder with the same base and height.

In fact, the volume of a cone is exactly one-third of the volume of a cylinder with the same base and height. The volume of a cone is

$$V = \frac{1}{3} Bh$$

Since the base of a cone is a circle, we can substitute the formula of area of a circle, πr^2 , for B to get the formula for volume of a cone.

$$V = \frac{1}{3} \pi r^2 h$$

Volume of a Cone

For a cone with radius r and height h .

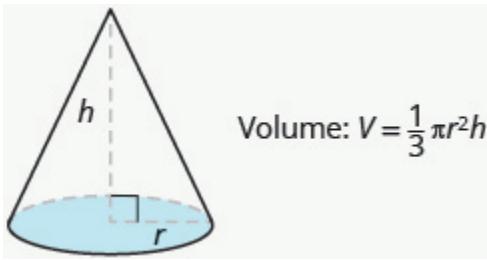

WEIGHTS AND MEASURES CONVERSION TABLES

LIQUID MEASURE

8 ounces = 1 cup

2 cups = 1 pint

16 ounces = 1 pint

4 cups = 1 quart

2 pints = 1 quart

4 quarts = 1 gallon

**3 teaspoons = 1
tablespoon**

**2 tablespoons = 1/8
cup or 1 fluid ounce**

**4 tablespoons = 1/4
cup**

**8 tablespoons = 1/2
cup**

1 teaspoon = 60 drops

Conversion of US Liquid Measures to Metric System

1 fluid ounce= 29.573 milliliters

1 cup= 230 milliliters

1 quart= .94635 liters

.033814 fluid ounce= 1 milliliter

3.3814 fluid ounces= 1 deciliter

33.814 fluid ounces or 1.0567 quarts= 1 liter

DRY MEASURE

2 pints= 1 quart

4 quarts= 1 gallon

8 quarts= 2 gallons or 1 peck

4 pecks= 8 gallons or 1 bushel

16 ounces= 1 pound

2000 pounds= 1 ton

CONVERSION OF US WEIGHT AND MASS TO METRIC SYSTEM

.0353 ounces= 1 gram

1/4 ounce= 7 grams

1 ounce= 28.35 grams

4 ounces= 113.4 grams

8 ounces= 226.8 grams

1 pound= 454 grams

2.2046 pounds= 1 kilogram

1.1023 short tons= 1 metric ton

LINEAR MEASURE

12 inches= 1 foot

3 feet= 1 yard

5.5 yards= 1 rod

40 rods= 1 furlong

8 furlongs (5280 feet)= 1 mile

6080 feet= 1 nautical mile

Conversion of US Linear Measures to Metric System

1 inch= 2.54 centimeters

1 foot= .3048 meters

1 yard= .9144 meters

1 mile= 1609.3 meters or 1.6093 kilometers

.03937 inches= 1 millimeter

.3937 inches= 1 centimeter

3.937 inches= 1 decimeter

39.37 inches= 1 meter

3280.8 feet or .62137 miles= 1 kilometer

TEMPERATURE

To convert Fahrenheit to Centigrade: Subtract 32, Multiply by 5, then Divide by 9

To convert Centigrade to Fahrenheit: Multiply by 9, Divide by 5, then Add 32

3.2 Ohm's Law, Joules Law, and Series/Parallel Formulas

OHM'S LAW

The current that flows through most substances is directly proportional to the voltage V applied to it. The German physicist Georg Simon Ohm (1787–1854) was the first to demonstrate experimentally that the current in a metal wire is *directly proportional to the voltage applied*: $I \propto V$.

This important relationship is known as Ohm's law. It can be viewed as a cause-and-effect relationship, with voltage the cause and current the effect. This is an empirical law like that for friction—an experimentally observed phenomenon. Such a linear relationship doesn't always occur.

Resistance and Simple Circuits

If voltage drives current, what impedes it? The electric property that impedes current (crudely similar to friction and air resistance) is called resistance R . Collisions of moving charges with atoms and molecules in a substance transfer energy to the substance and limit current. Resistance is defined as inversely proportional to current, or $I \propto \frac{1}{R}$.

Thus, for example, current is cut in half if resistance doubles. Combining the relationships of current to voltage and current to resistance gives $I = \frac{V}{R}$.

This relationship is also called Ohm's law. Ohm's law in this form really defines resistance for certain materials. Ohm's law (like Hooke's law) is not universally valid. The many substances for which Ohm's

law holds are called ohmic. These include good conductors like copper and aluminum, and some poor conductors under certain circumstances. Ohmic materials have a resistance R that is independent of voltage V and current I . An object that has simple resistance is called a resistor, even if its resistance is small. The unit for resistance is an ohm and is given the symbol Ω (upper case Greek omega). Rearranging $I = \frac{V}{R}$ gives $R = \frac{V}{I}$, and so the units of resistance are 1 ohm = 1 volt per ampere: $1 \Omega = 1 \frac{V}{A}$.

Figure shows the schematic for a simple circuit. A simple circuit has a single voltage source and a single resistor. The wires connecting the voltage source to the resistor can be assumed to have negligible resistance, or their resistance can be included in R .

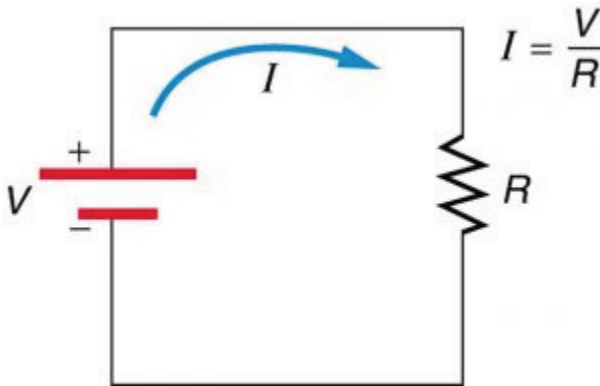

A simple electric circuit in which a closed path for current to flow is supplied by conductors (usually metal wires) connecting a load to the terminals of a battery, represented by the red parallel lines. The zigzag symbol represents the single resistor and includes any resistance in the connections to the voltage source.



An interactive or media element has been excluded from this version of the text. You can view it online here: <http://pressbooks.oer.hawaii.edu/buildingmaint/?p=150>

Making Connections: Real World Connections

Ohm's law ($V=IR$) is a fundamental relationship that could be presented by a linear function with the slope of the line being the resistance. The resistance represents the voltage that needs to be applied to the resistor to create a current of 1 A through the circuit. The graph (in the figure below) shows this representation for two simple circuits with resistors that have different resistances and thus different slopes.

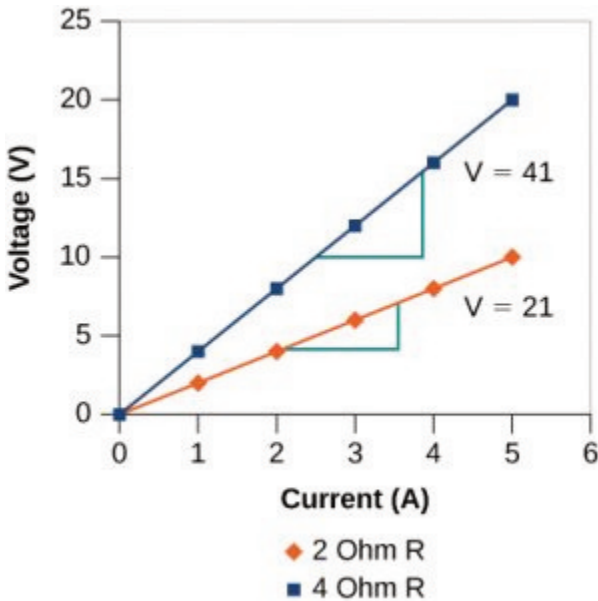

The figure illustrates the relationship between current and voltage for two different resistors. The slope of the graph represents the resistance value, which is 2Ω and 4Ω for the two lines shown.

The materials which follow Ohm's law by having a linear relationship between voltage and current are known as ohmic materials. On the other hand, some materials exhibit a nonlinear voltage-current relationship and hence are known as non-ohmic materials. The figure below shows current voltage relationships for the two types of materials.

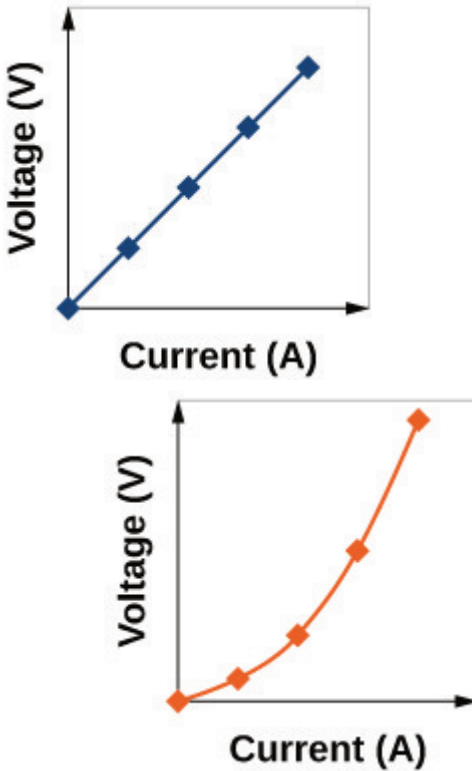

Figure #. The relationship between voltage and current for ohmic and non-ohmic materials are shown.

Clearly the resistance of an ohmic material (shown in (a)) remains constant and can be calculated by finding the slope of the graph but that is not true for a non-ohmic material (shown in (b)).

Resistances range over many orders of magnitude. Some ceramic insulators, such as those used to support power lines, have resistances of $10^{12}\Omega$ or more. A dry person may have a hand-to-foot resistance of $10^5\Omega$, whereas the resistance of the human heart is

about 103Ω . A meter-long piece of large-diameter copper wire may have a resistance of $10\text{--}5\Omega$, and superconductors have no resistance at all (they are non-ohmic). Resistance is related to the shape of an object and the material of which it is composed, as will be seen in Resistance and Resistivity.

Additional insight is gained by solving $I = \frac{V}{R}$ for V , yielding $V = IR$.

This expression for V can be interpreted as the *voltage drop across a resistor produced by the current I* . The phrase *IR drop* is often used for this voltage. For instance, the headlight in Example has an IR drop of 12.0 V . If voltage is measured at various points in a circuit, it will be seen to increase at the voltage source and decrease at the resistor. Voltage is similar to fluid pressure. The voltage source is like a pump, creating a pressure difference, causing current—the flow of charge. The resistor is like a pipe that reduces pressure and limits flow because of its resistance. Conservation of energy has important consequences here. The voltage source supplies energy (causing an electric field and a current), and the resistor converts it to another form (such as thermal energy). In a simple circuit (one with a single simple resistor), the voltage supplied by the source equals the voltage drop across the resistor, since $PE = q\Delta V$, and the same q flows through each. Thus the energy supplied by the voltage source and the energy converted by the resistor are equal. (See Figure.)

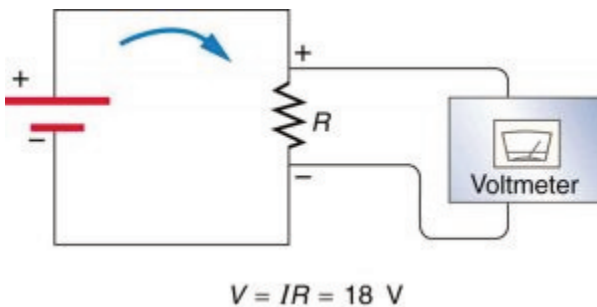

The voltage drop across a resistor in a simple circuit equals the voltage output of the battery.

Making Connections: Conservation of Energy

In a simple electrical circuit, the sole resistor converts energy supplied by the source into another form. Conservation of energy is evidenced here by the fact that all of the energy supplied by the source is converted to another form by the resistor alone. We will find that conservation of energy has other important applications in circuits and is a powerful tool in circuit analysis.



An interactive or media element has been excluded from this version of the text. You can view it online here: <http://pressbooks.oer.hawaii.edu/buildingmaint/?p=150>

RESISTORS IN SERIES AND PARALLEL

Most circuits have more than one component, called a resistor that limits the flow of charge in the circuit. A measure of this limit on charge flow is called resistance. The simplest combinations of resistors are the series and parallel connections illustrated in Figure. The total resistance of a combination of resistors depends on both their individual values and how they are connected.

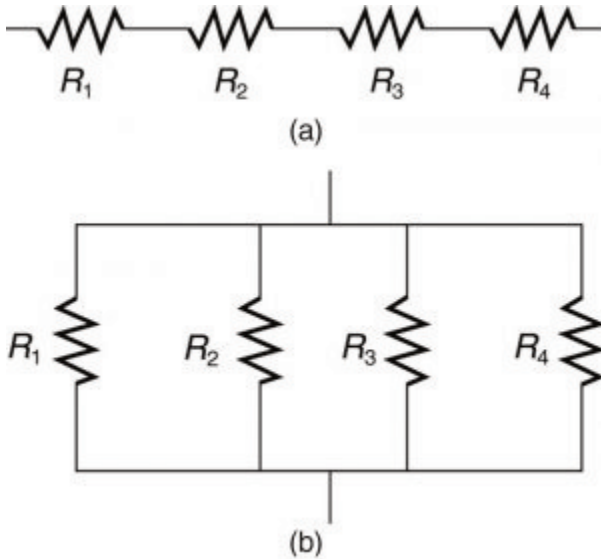

Image shows (a) A series connection of resistors. (b) A parallel connection of resistors.

When resistors are connected in parallel, more current flows from the source than would flow for any of them individually, and so the total resistance is lower.

JOULES LAW

Power is associated by many people with electricity. Knowing that power is the rate of energy use or energy conversion, what is the expression for electric power? Power transmission lines might come to mind. We also think of lightbulbs in terms of their power ratings in watts. Let us compare a 25-W bulb with a 60-W bulb. (See Figure(a).) Since both operate on the same voltage, the 60-W bulb must draw more current to have a greater power rating. Thus the 60-W bulb's

resistance must be lower than that of a 25-W bulb. If we increase voltage, we also increase power. For example, when a 25-W bulb that is designed to operate on 120 V is connected to 240 V, it briefly glows very brightly and then burns out. Precisely how are voltage, current, and resistance related to electric power?

Electric energy depends on both the voltage involved and the charge moved. This is expressed most simply as $PE = qV$, where q is the charge moved and V is the voltage (or more precisely, the potential difference the charge moves through). Power is the rate at which energy is moved, and so electric power is $P = \frac{PE}{t} = \frac{qV}{t}$.

Recognizing that current is $I = \frac{q}{t}$ (note that $\Delta t = t$ here), the expression for power becomes $P = IV$.

Electric power (P) is simply the product of current times voltage. Power has familiar units of watts. Since the SI unit for potential energy (PE) is the joule, power has units of joules per second, or watts. Thus, $1 \text{ A} \cdot \text{V} = 1 \text{ W}$. For example, cars often have one or more auxiliary power outlets with which you can charge a cell phone or other electronic devices. These outlets may be rated at 20 A, so that the circuit can deliver a maximum power $P = IV = (20 \text{ A})(12 \text{ V}) = 240 \text{ W}$. In some applications, electric power may be expressed as volt-amperes or even kilovolt-amperes $1 \text{ kA} \cdot \text{V} = 1 \text{ kW}$.

To see the relationship of power to resistance, we combine Ohm's law with $P = IV$. Substituting $I = V/R$ gives $P = \left(\frac{V}{R}\right)V = V^2/R$. Similarly, substituting $V = IR$ gives $P = I(IR) = I^2R$. Three expressions for electric power are listed together here for convenience:

$$P = IV$$

$$P = V^2/R$$

$$P = I^2R.$$

Note that the first equation is always valid, whereas the other two can be used only for resistors. In a simple circuit, with one voltage source and a single resistor, the power supplied by the voltage source and that dissipated by the resistor are identical. (In more complicated

circuits, P can be the power dissipated by a single device and not the total power in the circuit.)

Different insights can be gained from the three different expressions for electric power. For example, $P = V^2/R$ implies that the lower the resistance connected to a given voltage source, the greater the power delivered. Furthermore, since voltage is squared in $P = V^2/R$, the effect of applying a higher voltage is perhaps greater than expected. Thus, when the voltage is doubled to a 25-W bulb, its power nearly quadruples to about 100 W, burning it out. If the bulb's resistance remained constant, its power would be exactly 100 W, but at the higher temperature its resistance is higher, too.

Joule's Law



An interactive or media element has been excluded from this version of the text. You can view it online here:
<http://pressbooks.oer.hawaii.edu/buildingmaint/?p=150>

PART 4: PLUMBING SYSTEMS

Plumbing Systems

PLUMBER APPRENTICESHIP, EXPERIENCE, AND EDUCATION REQUIREMENTS

A plumber must be qualified, and potentially licensed, to repair certain aspects of a plumbing system. Many plumbing repairs involve working with water, electricity, and gas; special care should be taken during installation and repairs that require working with potential hazards inherent to these things.

MOST STATES AND MUNICIPALITIES REQUIRE PLUMBERS TO BE LICENSED.

HAWAII REQUIREMENTS:

1) Provide verification of the following:

- Journey Worker Plumber (PJ)- 5 years but not less than 10,000 hours of plumbing work in compliance with the Uniform Plumbing Code (UPC).
- Master Plumber (PM)- 2 years experience as a licensed journey worker plumber or equivalent.

2) PASS THE BOARD'S EXAMINATION

(Reference: http://files.hawaii.gov/dcca/pvl/faqs/electrician_plumber_faq.pdf)

LICENSE RENEWAL

Prior to every license renewal, all licensed plumbers must meet continued competency requirements to renew their license:

“The licensee shall submit (1) a copy of a certificate from a University of Hawaii Community College evidencing attendance at an update course of the “UPC” or (2) a copy of a score report from Prometric verifying successful passage of the continued competency exam on the updates to the “UPC”.”

Plumbing Codes

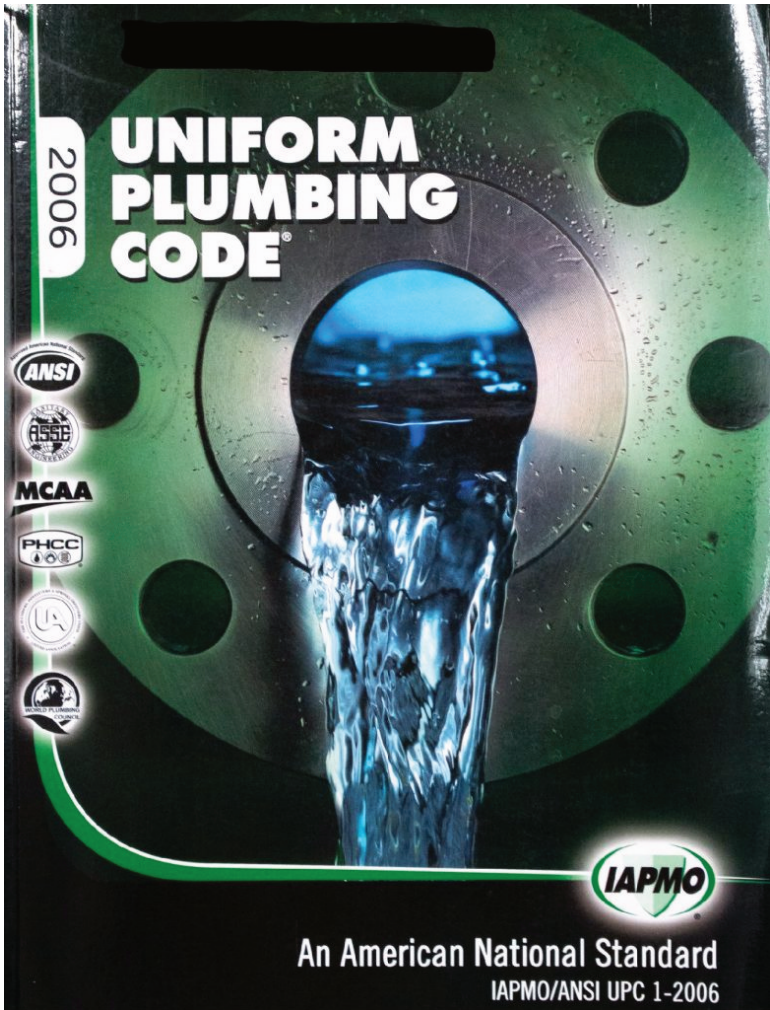

UPC 2006 Code Book by Gwen Arkin is licensed under CC BY 4.0

Uniform Plumbing Code

- Published every 3 years by the International Association of Plumbing and Mechanical Officials (IAMPO)
- Not a federal law
- Regionally adoptable by states and municipalities (Some municipalities have elected to adopt the International Plumbing Code (IPC))
- Adopted in all 50 states
- Most jurisdictions do not immediately adopt new additions.
- As of April 2017, Maui County still uses the 2006 edition of the UPC to enforce safe practices

4.1 Piping & Fittings

Pipes

Installing, maintaining, and troubleshooting plumbing systems requires specific knowledge of industry standardized measurements, construction codes, and specialized components of plumbing systems. While locally adopted plumbing codes apply to these systems and components, manufacturer installation and use instructions should be followed. Many common plumbing parts and materials like pipes and fittings do not come with instructions and should be sized and installed to comply with locally adopted plumbing and building codes.

A pipe or fitting's ability to hold pressure, survive hot or cold temperatures, and endure natural elements is limited by its chemical composition, wall strength, and integrity of the sealing method used to join individual components. Schedule is the term used in referring to "plastic" (PVC, ABS, CPVC) pipe's wall thickness, with lower numbers representing thinner walled pipes. The most common sizes used in residential construction are Schedule 40 (thinner wall used in drain, waste and vent applications) and Schedule 80 (thicker wall used in pressurized water applications). Several material types are approved for use in piping system that serve different purposes in a complete plumbing system to include water supply, and waste, drain and vent (DWV). The following table indicates the type of plumbing system that various types of piping are generally allowed in residential and light commercial construction:

Common Material Types	Supply	Waste	Drain	Vent
Copper	Yes	No	No	No
PEX	Yes	No	No	No
PVC	Yes*	Yes	Yes	Yes
CPVC	Yes**	No	No	No
ABS	No	Yes	Yes	Yes
Cast Iron	No	Yes	Yes	Yes
No-hub	No	Yes	Yes	Yes
Galvanized Pipe	Yes	No	No	No
Black Iron Pipe***	No	No	No	No

Fittings

Fittings are used to join and redirect pipes and components to form complete plumbing systems. Due to the variety of designs of plumbing system components, fittings also facilitate adaptations from one size diameter of pipe or fitting to another. While many styles of fittings are used in most all types of systems, plumbing codes only allow some fittings to be used in particular type of plumbing system (supply or DWV) and have strict requirements as to how they are to be incorporated into the system (ex: compression fittings and unions should never be used inside of walls).

FITTING TERMINOLOGY

National Pipe Thread (NPT)



American standard thread used in plumbing and piping systems. It may also be referred to as MPT or MNPT for male external threads and FPT or FNPT for female internal threads. A thread sealant of some type should always be used to obtain a leak free seal (except for NPTF).

Iron Pipe Size (IPS)



Older pipe sizing system still in use by some industries, including PVC pipe manufacturers.

National Pipe Thread (NPT)



American standard thread used in plumbing and piping systems. It may also be referred to as MPT or MNPT for male external threads and FPT or FNPT for female internal threads. A thread sealant of some type should always be used to obtain a leak free seal (except for NPTF).

Slip fittings



Slip fittings require a male component with a particular outside diameter to be joined with a female component with a similarly sized inside diameter either by solvent, glue, or, when using copper components, soldering.

National Pipe Thread (NPT)



American standard thread used in plumbing and piping systems. It may also be referred to as MPT or MNPT for male external threads and FPT or FNPT for female internal threads. A thread sealant of some type should always be used to obtain a leak free seal (except for NPTF).

Couplings



Couplings are designed to join two pipes of equal diameter. Couplings can be slip-to-slip or female thread to female thread.

National Pipe Thread (NPT)



American standard thread used in plumbing and piping systems. It may also be referred to as MPT or MNPT for male external threads and FPT or FNPT for female internal threads. A thread sealant of some type should always be used to obtain a leak free seal (except for NPTF).

Bushings

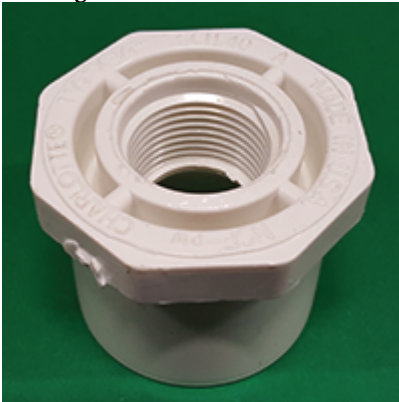

This fitting allows a pipe or fitting to be reduced to a smaller size and are made to be inserted into a pipe, inside slip, or female thread. Bushings outside diameter can be male thread or male slip with the inside diameter, being of the same style (slip or thread) as the outside, dictating the size the piping system is reduced to.

Adapters



Similar to bushings, adapters are used to convert pipes and fittings from one size to another. Unlike bushings, adapters can allow for conversion from slip to thread applications and, in some cases, one piping material type to another.

National Pipe Thread (NPT)



American standard thread used in plumbing and piping systems. It may also be referred to as MPT or MNPT for male external threads and FPT or FNPT for female internal threads. A thread sealant of some type should always be used to obtain a leak free seal (except for NPTF).

Elbows



Elbows normally create a 90° or 45° change in direction of a piping system. 22-1/2° fittings are also available for some piping systems. Depending on the material, elbows come in female slip-to-female slip, female slip-to-female slip, slip-to-female thread, slip-to-male thread. PVC and Copper female slip-to-male slip elbows are referred to as street elbows and they are used for close turns and swivel to fit connections.

National Pipe Thread (NPT)



American standard thread used in plumbing and piping systems. It may also be referred to as MPT or MNPT for male external threads and FPT or FNPT for female internal threads. A thread sealant of some type should always be used to obtain a leak free seal (except for NPTF).

Tees



Tees connect pipes at 90 degree angles divide the flow of a single line into two or more. Tees can also be used to reduce the size of a branch feeding off of a main line. Tees are normally fitted with female threads in each direction.

National Pipe Thread (NPT)



American standard thread used in plumbing and piping systems. It may also be referred to as MPT or MNPT for male external threads and FPT or FNPT for female internal threads. A thread sealant of some type should always be used to obtain a leak free seal (except for NPTF).

Plugs



Plugs are male thread or male slip and designed to seal off unused plumbing system branches or unused component outlets.

National Pipe Thread (NPT)



American standard thread used in plumbing and piping systems. It may also be referred to as MPT or MNPT for male external threads and FPT or FNPT for female internal threads. A thread sealant of some type should always be used to obtain a leak free seal (except for NPTF).

Caps

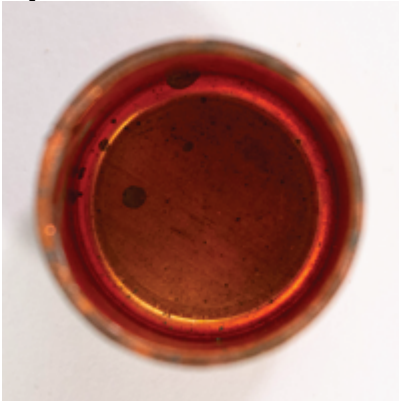

Caps, like plugs, are designed to seal off unused plumbing system branches or unused component outlets, but have female slip fittings or threads.

Unions



Unions facilitate the removal and repair of system components and consist of one fitting having a swivel nut which attaches to the other fitting which has a male threaded adapter with a flange or compression type seal.

National Pipe Thread (NPT)



American standard thread used in plumbing and piping systems. It may also be referred to as MPT or MNPT for male external threads and FPT or FNPT for female internal threads. A thread sealant of some type should always be used to obtain a leak free seal (except for NPTF).

Compression fittings

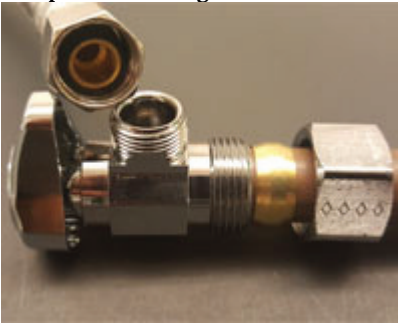

Compression fittings are sometimes used to install plumbing system components and make quick repairs on smooth outside diameter pipes like PVC and copper. Compression fittings require that a soft brass metal sleeve in copper applications, and Teflon or pliable washer in PVC applications, is compressed around the piping material by an adjustment nut to seal the fitting.

National Pipe Thread (NPT)



American standard thread used in plumbing and piping systems. It may also be referred to as MPT or MNPT for male external threads and FPT or FNPT for female internal threads. A thread sealant of some type should always be used to obtain a leak free seal (except for NPTF).

Wyes



Wyes are Y-shaped fittings that allow one pipe to be joined to another at a 45 degree angle. Wyes are not used in water supply systems, but are common in DWV systems where hard turns slow the flow of waste.

National Pipe Thread (NPT)



American standard thread used in plumbing and piping systems. It may also be referred to as MPT or MNPT for male external threads and FPT or FNPT for female internal threads. A thread sealant of some type should always be used to obtain a leak free seal (except for NPTF).

Tee-Wyes



Tee-Wyes are similar to standard wyes but provide an additional 45 degree branch.

National Pipe Thread (NPT)



American standard thread used in plumbing and piping systems. It may also be referred to as MPT or MNPT for male external threads and FPT or FNPT for female internal threads. A thread sealant of some type should always be used to obtain a leak free seal (except for NPTF).

Sanitary Tees



Sanitary Tees should be used when connecting a horizontal run, such as a waste arm to a vent stack or vertical riser. They are only used to go from the horizontal to vertical plane.

National Pipe Thread (NPT)



American standard thread used in plumbing and piping systems. It may also be referred to as MPT or MNPT for male external threads and FPT or FNPT for female internal threads. A thread sealant of some type should always be used to obtain a leak free seal (except for NPTF).

Clean-Outs



Clean-Outs are threaded plugged access points in a DWV system used for clearing clogged lines with augers and inspecting DWV systems with cameras. Plumbing system codes dictate how many clean-outs should be in a waste system by the length of run and the amount of turns in the system.

Fittings by Clifford Rutherford, Rosemary Rutherford & Gwen Arkin is licensed under CC BY 4.0

Fitting	Supply	Waste	Drain	Vent
Coupler	Yes	Yes	Yes	Yes
90 degree elbow or offset	Yes	No	Yes	Yes
90 degree sweep	No	Yes	Yes	Yes
45 degree elbow or offset	Yes	No	Yes	Yes
45 degree sweep	No	Yes	Yes	Yes
Tee	Yes	No	No	Yes
Tee-Wye	No	Yes	Yes	Yes
Sanitary Tee	No	Yes	Yes	Yes
Adapter	Yes	Yes	Yes	Yes
Bushing	Yes	Yes	Yes	Yes
No-hub	No	Yes	Yes	Yes

Nominal Pipe Size	Outside Diameter	Wall Thick. (Sch 40)	Wt. Per Ft. (Sch 40)	Wall Thick. (Sch 80)	Wt. Per Ft. (Sch 80)
1/8	0.405	0.068	0.245	0.095	0.315
1/4	0.540	0.088	0.425	0.119	0.535
3/8	0.675	0.091	0.568	0.126	0.739
1/2	0.840	0.109	0.851	0.147	1.088
3/4	1.050	0.113	1.131	0.154	1.474
1	1.315	0.133	1.679	0.179	2.172
1-1/4	1.660	0.140	2.273	0.191	2.997
1-1/2	1.900	0.145	2.718	0.200	3.631
2	2.375	0.154	3.653	0.218	5.022
2-1/2	2.875	0.203	5.793	0.275	7.661
3	3.500	0.216	7.576	0.300	10.250
3-1/2	4.000	0.226	9.109	0.318	12.510
4	4.500	0.237	10.790	0.337	14.980
5	5.563	0.258	14.620	0.375	20.780
6	6.625	0.280	18.970	0.432	28.570
8	8.625	0.322	28.550	0.500	43.390
10	10.750	0.365	40.480	0.500	54.740
12	12.750	0.375	49.560	0.500	65.420

Solvent Cleaners, Primers, & Cements or Glues



Pipe Glues & Primers by Gwen Arkin is licensed under CC BY 4.0

The use of cleaners, primers, and glues is specific to slip fitting applications and the chemical composition of the “plastic” piping being used. Chemical resistant gloves should be worn when using these chemical process adhesives as prolonged skin contact can result in irritation or chemical burn. Latex and vinyl gloves are not chemically resistant when used with some solvents, primers, and glues.

Always consult manufacture directions for set times of cements and glues before pressurizing any glued plumbing assembly. When assembling fittings and pipes, cleaners, primers and glues should be swabbed over the entire joint surface of both the male and female slip fitting. Although manufacturer directions may vary, in most cases

a cleaner should be used, followed by a primer and then the solvent cement. Additionally, after application of the primer, the solvent cement should be applied immediately before the primer dries. Before the glue begins to set up, the male pipe or fitting is inserted fully into the female socket with a slight twisting motion. It is important to hold the joint firmly together until an initial setting of the glue is achieved, as glued fittings have a tendency to push apart as the chemical heats and expands.

COLOR AND MATERIAL

Most manufacturers of these chemically reactive products have adopted colors in their products that identify the composition of material it is to be used with.

Primers and Cleaners (Clear or Purple)



Formulated to remove contaminates and chemically etch plastic piping. While some cleaners are clear, purple tinted primer stains white PVC enabling the user to ensure that all surfaces requiring glue are properly cleaned and etched.

All Purpose Cement (Clear)



Used with PVC, ABS, and CPVC, but should never be used to join two of the different types together.

Wet-or Dry (Rain-or-Shine™) Cement (Blue)



For PVC in damp applications. However, care should be used to keep fittings as dry as possible as these types of glues do not always set well if assembly is submerged.

Transition Cement (Green)

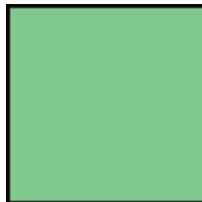

Used to join ABS to PVC. Although not a common practice, some special circumstance and repair applications may require these two materials to be joined.

CPVC Cement (Orange)

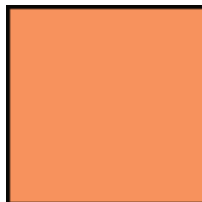

Specially formulated to only be used with CPVC products. CPVC piping and fittings should only be joined to other types of products with threaded fittings.

Primers and Cleaners (Clear or Purple)



Formulated to remove contaminants and chemically etch plastic piping. While some cleaners are clear, purple tinted primer stains white PVC enabling the user to ensure that all surfaces requiring glue are properly cleaned and etched.

ABS Cement (Black)



For ABS piping systems only. Note that primers should NOT be used for ABS pipe and that cleaner should be used in its place.

Color Blocks by Jonathan Kevan is licensed under CC BY 4.0

Difference Between PVC Cement Types & Primer



An interactive or media element has been excluded from this version of the text. You can view it online here:

<http://pressbooks.oer.hawaii.edu/buildingmaint/?p=157>



An interactive or media element has been excluded from this version of the text. You can view it online here:
<http://pressbooks.oer.hawaii.edu/buildingmaint/?p=157>

Threaded Pipe Fitting Assembly

Most pipe threads by themselves are not sufficient to create a complete seal in pressurized piping systems.

THREAD TAPE



Teflon Tapes by Gwen Arkin is licensed under CC BY 4.0

IPS and NPT pipe threads require Polytetrafluoroethylene (PTFE) tape (Teflon™ by Chemours) to be applied to the male threads of fittings in order to obtain a complete seal. PTFE tape is available in widths of 1/2", 3/4" and 1" and different weights or thicknesses (white-standard duty, pink-high density). The standard duty tape should be wrapped completely and evenly across the male threads

approximately three to four times in the direction the threads turn to tighten the fitting. The easiest way to accomplish this is to place the tape roll in the left hand with the tape feeding toward the right from the bottom. While holding the male fitting with the right hand, place the end of the tape across the top of the fitting and turn the fitting clockwise. After securing the first 1 to 1-1/2 wraps, gently stretch the tape, continuing to turn while overlapping layers up and down the threads until 3 to four complete wraps are achieved evenly across the length of the male threads. Pull the tape firmly to break and thread male fitting into female fitting, securing with an appropriate wrench.

Standard or high density PTFE thread pipe cannot, by codes, be used for natural gas and propane applications. A chemically resistant yellow version is used for these flammable gas systems.

PIPE DOPE



Pipe Dope by Gwen Arkin is licensed under CC BY 4.0

As with thread tape, pipe dope comes in PTFE and other compositions designed for water lines and for gas lines. While some people use pipe dope on top of thread tape but many manufactures claim that there is minimal or no benefit to using both products simultaneously. Some pipe dopes cannot be used on plastic piping, be sure to check manufacturer directions prior to use. Pipe dope is applied with a brush to the male threads of a piping joint and then the pipe is tightened into the female fitting and secured with an appropriate wrench.

Copper Pipe Fitting and Soldering

Due to the ever rising cost of copper material, soldering of copper pipes and fittings in residential construction is rapidly becoming obsolete as PEX flexible water supply tubing and similar solderless products, that use crimping system technologies, are being recognized and approved for installation by industry codes. However, plumbers and building maintenance technicians should always be prepared to use soldering techniques to install and repair copper supply lines of all sizes in commercial and older residential systems.

SIMPLE STEPS FOR SOLDERING

1. Clean the pipe well.
2. Clean the fitting well.
3. Apply an even coat of flux.
4. Don't get the fitting too hot.



An interactive or media element has been excluded from this version of the text. You can view it online here:
<http://pressbooks.oer.hawaii.edu/buildingmaint/?p=157>

4.2 Domestic Water Service

Potable Water

Often referred to as drinking water or domestic water, **potable water** is water that is considered to be safe for human consumption. Plumbers and maintenance technicians should always be aware of the potential for contamination of potable water systems and guard against it when installing, opening, and repairing these vulnerable systems.

Plumbing codes are very specific about maintaining the integrity of potable water systems to be free of harmful contaminants to protect the health and well being of individuals that rely on them. If a water service is installed in the same trench as a drain or sewer, the possibility of back-flow could occur. To protect against this, codes regulate the installation of a water service in the same trench with or within a certain distance of waste system piping. Most codes require that a water service installed at the same elevation as a sewer must be separated from the sewer by at least 5' of undisturbed or compacted soil (This code often dictates that a separate trench is to be excavated). Additionally, lead-free regulations now affect how brass, bronze, copper, and other metal fittings and components are made and the solders that are used to assemble some of them.

Specialty Tools

Specialty tools often make tasks easier to perform and there is no

shortage of specialty tools in the plumbing field. Many are specific to a particular manufacturer, while other perform functions that are relative to the plumbing field.



An interactive or media element has been excluded from this version of the text. You can view it online here:
<http://pressbooks.oer.hawaii.edu/buildingmaint/?p=160>

Water Meters

Water meters are used by municipal water systems to monitor and record water usage for billing purposes. Most in-ground water meters are secured in a meter box that requires a specially shaped forged key (available at specialty plumbing supply vendors) to open. Every water meter has a direction of flow and an arrow indicating which side is the incoming or outgoing connection. A municipal shut-off valve located before the meter (inlet side) normally has a rectangular shaped lock-out device that can be turned on or off with a fitted T-handle device or open end wrench. Turning this valve to the off position allows for the water supply to the entire property the meter services to be cut off and for the meter to be removed or serviced. A ball or gate valve should be installed in a valve box located outside of the meter box on the outlet side for customers or service technicians to access in order to shut off water service in the event of an emergency.

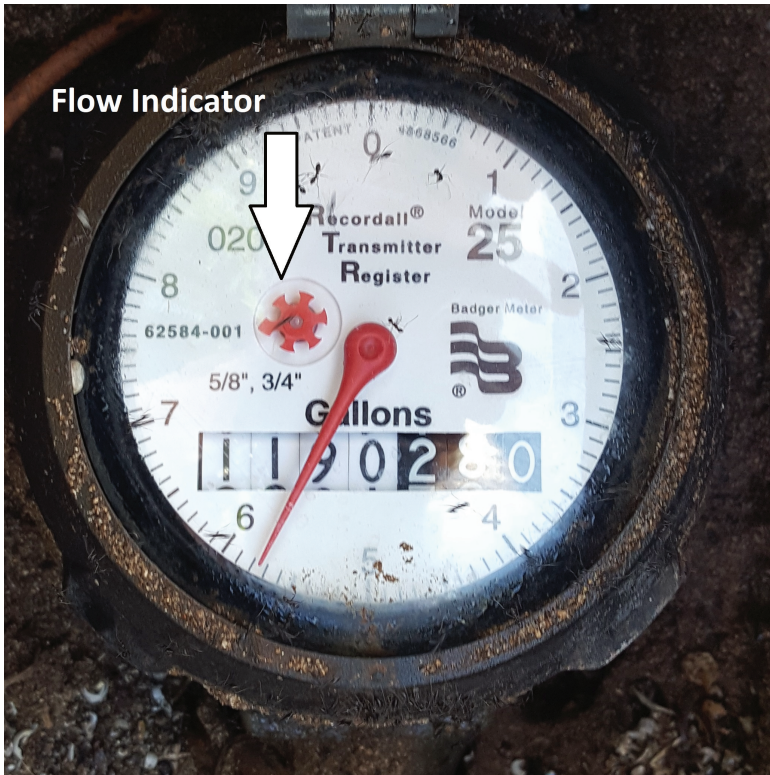

Water Meter by Clifford Rutherford is licensed under CC BY 4.0

CHECKING FOR LEAKS WITH A RESIDENTIAL WATER METER:

Be sure all faucets and hose bibs in the residence are turned off.

Ensure that nobody will be flushing the toilets.

Turn off supply line to refrigerator ice makers and water dispensers.

Watch to see if the small flow indicator dial on the meter is turning.

- If the indicator appears to be stopped, make a temporary marking that indicates the position of the flow indicator dial and wait 5 minutes to see if the indicator moves.
- If the indicator is turning on initial inspection, or has moved within 5 minutes of being marked at a fixed position, and nobody in the residence is using the water:
 - Turn off supply water to any water features one at a time including: spas, swimming pools, and ponds; checking the flow indicator between each one. If the indicator on the meter ceases to turn after turning off a particular water feature, check the supply valve/float valve or filling system of that feature for leaks.
 - Turn off angle stops at toilets one at a time and check the water meter flow indicator to see if it has stopped moving between turning off the supply at each toilet. If the indicator ceases to turn after turning off a particular toilet's angle stop, follow procedures for troubleshooting toilet fill and flush valves in that toilet.

If all of these procedures have been performed and the flow indicator dial continues to turn, it is possible that there is an underground, under-slab, or in-wall leak. As in-wall leaks are usually apparent, it is more likely that leak would be in the ground or under-slab and a professional licensed plumber should be consulted.

Residential Piping

Rough-in water supply piping is usually installed after the completion of the drainage and vent piping because the water piping system

consumes less space in walls and ceilings. The drainage and piping must be installed with specific fittings and in certain positions to allow the water to flow by gravity, and water supply system installation requirements are less rigid than drain, waste, and vent systems.

SYSTEM PIPE SIZE REQUIREMENTS

While the International Plumbing Code (IPC) and the Uniform Plumbing Code (UPC) differ slightly in their pipe sizing allowances, both use similar criteria for the sizing of piping systems. The sizing of an entire system is established based on the quantity and type of fixtures being served, and designed based on the maximum GPM or per flushing cycle of a particular fixture and then calculated as per all the fixtures.

Fixture	UPC Smallest Size	IPC Smallest Size
Bathtub	1/2"	1/2"
Large Capacity Bathtub	Not Identified	1/2"
Bathtub 3/4" Fill Valve	3/4"	Not Identified
Bidet	1/2"	3/8"
Dishwasher	1/2"	1/2"
Hose Faucet	1/2"	1/2"
Kitchen Sink	1/2"	3/8"
Laundry Sink	1/2"	3/8"
Lavatory Sink	1/2"	3/8"
Single Shower Head	1/2"	3/8"
Toilet	1/2"	3/8"

4.3 Drain, Waste, and Vent (DWV)

Drain, Waste and Vent (DWV) systems can be complex and extensive as pipe routes are a result of determining fixture locations, fixture requirements, relative codes, construction obstacles, and company installation standards. Understanding of the basic layout of these systems can be crucial to plumbers and maintenance technicians when diagnosing and clearing blockages, and troubleshooting other drain and sewer abnormalities.

DWV Terminology

Building Sewer

A building sewer is the main pipe used to transport sewage and wastewater from a DWV system to a point of disposal, or termination (ex. a municipal sewer line).

Clean-Outs

The start of a building sewer is typically where a clean-out is installed with its connection to the building drain. Clean-outs are installed in various locations throughout a system and the maximum distances are found in a code books, they typically cannot be more than 100'

apart. All codes dictate that the base of every stack and the transition from a building drain and building sewer must have a clean-out installed. Sizing is based on a clean-out being the same size as the pipe when serving a stack, building drain, and building sewer, but some codes allow exceptions for pipe sizes larger than 4”.



Clean-Out Key by Gwen Arkin is licensed under CC BY 4.0

Building Drain

The building drain is the lowest horizontal portion of a drainage

system and receives discharge from waste stacks and horizontal branches. Many codes state that it must extend at least 2'-6" and a maximum of 10'-0" from the exterior of the building.

Waste Stack

The waste stack is the main vertical pipe that starts with its connection at the building drain and terminates with its connection to the stack vent. It receives discharge from all horizontal branches and must have a clean-out at its base.

Stack Vent

The vent for the waste stack is known as the stack vent and begins at the highest branch connection to the waste stack. It is a dry piping system that typically extends through the roof, but can connect with the vent stack prior to terminating to open air.

Vent Stack

A vent stack is sized based on numerous factors including the total discharge load of a system and the length it travels. The vent stack can transition horizontally without requiring a relief vent. Like all horizontal vents, it must have adequate slope to eliminate moisture from settling and obstructing its airway. A clean-out is most often required to be installed at its base by plumbing and building codes .

Fixture Drain

The fixture drain serves a single fixture trap and is sized based on the particular fixture load. Most codes allow a removable joint of a trap assembly to act as a clean-out for a fixture drain. A floor drain or shower drain with a removable strainer can also serve as a clean-out for a fixture drain. Though a drain cannot be smaller than 1 -1/4" diameter, most codes dictate that the smallest drain size buried below ground is 2" diameter.

Fixture Branch

The fixture branch is a drainpipe that connects more than one fixture drain to a horizontal branch or major segment of a DWV system.

Horizontal Branch

A horizontal branch is a drainpipe that connects horizontally to a major segment of a DWV system. It can either connect to a waste stack or building drain. It connects more than one fixture drain or a fixture branch to a main segment of DWV system.

Individual Vent

Individual vents serve one fixture trap and are a vertical extension

of a drain. They must be at least half the diameter of the drain they serve, but no smaller than 1 -1/4”.

Branch Vent

The branch vent serves as a vent for a horizontal branch and connects to the a vent stack or a stack vent. A branch vent is sized based on the size of the horizontal branch, the drainage load of the horizontal branch, and the distance it travels.

Circuit Vent

A circuit vent, mainly used in commercial applications, is a branch vent that is not typical with other standard branch vent types and has specific code regulations. Single-family residential construction typically does not use “battery” configurations designed for institutional style multiple fixture applications due to the minimal number of fixtures located within one room.

Loop Vent

The loop vent is a circuit vent that is installed on a top floor of a building or highest branch. All sizing and code regulations are the same as those for a circuit vent.

Relief Vent

A relief vent is required when a waste stack transitions from vertical to horizontal. The most common relief vent is one serving a battery of fixtures. A relief vent serving a battery of fixtures is sized based on being half the diameter of the horizontal branch, but as with all other vents, it cannot be less than 1-1/4".

Trap

Every plumbing fixture connected to a drainage system must be protected by a fitting or device that serves as a protective water seal to prevent harmful sewer gas from entering an occupied space. This device is called a trap. A **p-trap** gets its name from its appearance, which resembles the letter P, and is installed receiving the outlet flow of waste water from a fixture. P-traps are available in a variety of styles, which include one-piece and two-piece designs and are designed to serve wall entry connections to the branch drain pipe, whereas **S-traps** are designed to serve floor entry connections to the drain pipe. The joints of a trap and its connections to the drain and fixture it serves are commonly assembled with compression style fittings similar to a union.



P-Trap by Gwen Arkin is licensed under CC BY 4.0

Trap Adapter

A slip-joint p-trap is tubular size and has a smaller outside diameter than the connecting DWV pipe. The fitting for connecting tubular sizes to DWV pipe sizes is referred to as a trap adapter and sometimes also called a desanco. A trap adapter is usually installed during the fixture installation phase of a project. Cast iron, copper, and galvanized piping systems use brass trap adapters.

Drain Cleaning

If you talk to any plumber or maintenance technician that has long-term experience with clearing clogged sewer and drain lines, you'll be amazed with the stories of the unthinkable items they have cleared or retrieved from DWV systems. Food and human waste, jewelry, silverware; toys, mop heads, and tree roots; beach towels, linen, and personal hygiene products; birds' nests, tree waste and fruit dropped by animals into vent systems, and more, They've seen it all!

Chemical drain cleaners, plungers, hooked flexible plastic extraction devices, and other gadgets can clear clogged p-traps and other clogs in drain lines relatively close to fixtures, some clogs require plumbing and maintenance technicians to use a manual or motorized drum auger to clear them.

How To Unclog a Drain Using a BrassCraft Drum Auger



An interactive or media element has been excluded from this version of the text. You can view it online here:
<http://pressbooks.oer.hawaii.edu/buildingmaint/?p=164>

If a hand or drill operated auger does not clear a clog, a heavy-duty motorized auger may need to be run through a clean-out to clear the obstruction. An assortment of auger heads can be attached to the auger cable to cut through obstructions like human and food waste,

tree roots, and other malleable objects, or grab and retrieve objects dropped or flushed down drains.

Easy Rooter Power Drain Cleaner – How To Video



An interactive or media element has been excluded from this version of the text. You can view it online here:
<http://pressbooks.oer.hawaii.edu/buildingmaint/?p=164>

Drain service technicians are sometimes unable to clear obstructions and use a drain and sewer inspection camera to identify what the obstruction is, and with a locator accessory, can pinpoint the location and depth of the obstruction in relation to the piping route including depth.

SeeSnake® MAX rMzoo Camera System



An interactive or media element has been excluded from this version of the text. You can view it online here:
<http://pressbooks.oer.hawaii.edu/buildingmaint/?p=164>

4.4 Valves & Prevention Devices

Many devices and faucets are considered to be valves, and numerous valve designs exist and many have multiple uses. Valves and devices installed for potable water must be approved by plumbing codes. Threaded valves and devices typically have female threads, however soldered connections are used for many valves and devices connecting to copper tube and plastic valves and devices are available with solvent welded connections. Backflow devices are installed to protect a potable water system, but an air gap is the only sure method of backflow prevention.

Isolation Valves

Every residential dwelling is required by code to be provided with at least one isolation valve. The valve must be installed in a easily accessible location, so the homeowner can shut off the water supply in case of an emergency or a repair. Most codes require that the minimum size of a residential water service be 3/4". Actual size is based on the number of plumbing fixtures.

Many codes dictate that the main isolation valve for a house and the isolation valve for a water heater be a full port design. A full port valve has the same inside diameter (ID) as the connecting pipe and does not drastically restrict the volume of water that flows through a valve. Some isolation valves and most devices installed in a piping system have a direction of flow and require an installer to connect the piping system knowing the flow direction of the water or gas.

Types of Isolation Valves & Residential Uses

Ball Valve- Water and Gas: Utilizes an internal ball with a hole in its center that creates a flow passageway through the valve, and isolates flow when the ball is rotated 90° from the flow direction. Some types of ball valves are available with a T-handle, but the most common have a lever handle. The internal ball has a vertical stem protruding from the valve body, to which the lever handle is secured with a tightening nut.



Ball Valve – Full Port vs. Standard by Gwen Arkin is licensed under CC BY 4.0

Gate Valve- Water: Utilizes a metal gate (disc) that slides vertically to open and close the valve. A wheel handle that is fixed to a stem raises and lowers the internal gate when manually turned. The handle

is turned counterclockwise to open the valve and clockwise to close the valve. The two basic self-explanatory types of gate valves are a rising stem type and a non-rising stem type.



Gate Valve by Gwen Arkin is licensed under CC BY 4.0

Stop Valve- Water: A valve design that uses a rubber washer to stop the flow of water; it is a directional flow isolation valve. A stop is a restrictive port valve, which is one reason it is no longer widely used in a piping system. A stop is more popular as an individual fixture isolation valve. Commonly installed as the connection between the water distribution system and the fixture tubing connection. Modern fixture supply stops incorporate a 1/4 turn ball valve design in place of a rubber washer assembly to shut off the flow of water. Angled and straight stops for individual fixture isolation are manufactured with chrome and brass finishes. While stops for modern residential applications usually use compression style fittings, older residential and contemporary commercial buildings often are fitted with threaded stops.



How To Install a BrassCraft Compression Valve



An interactive or media element has been excluded from this version of the text. You can view it online here:
<http://pressbooks.oer.hawaii.edu/buildingmaint/?p=177>

Stop and Waste Valve- Water: A stop and waste valve uses the same design as a stop valve to isolate an entire water distribution system, except that it also has a draining feature. When freezing is a concern or the need to drain a small portion of a piping system is required, a stop and waste valve is installed. A stop and waste valve cannot be installed in locations where water could enter the water distribution system through the drain portion. Backflow of non-potable water could enter the drain port while the water distribution system was not under pressure. Some ball valves are available with a waste valve feature.

Gas Cock- Gas: Used for gas distribution systems, a gas cock is used more as a means of isolating entire systems, and utility providers commonly use it for isolating gas meters.. Many ball valve designs for gas isolation are manufactured with a T-handle design, which differs from the typical WOG (water, oil, and gas) ball valve lever handle. Many designs do not have a manual handle such as a lever or wheel handle, but require a wrench to open and close the gas cock. A ball valve specifically designed for gas systems is not rated for use with other systems.

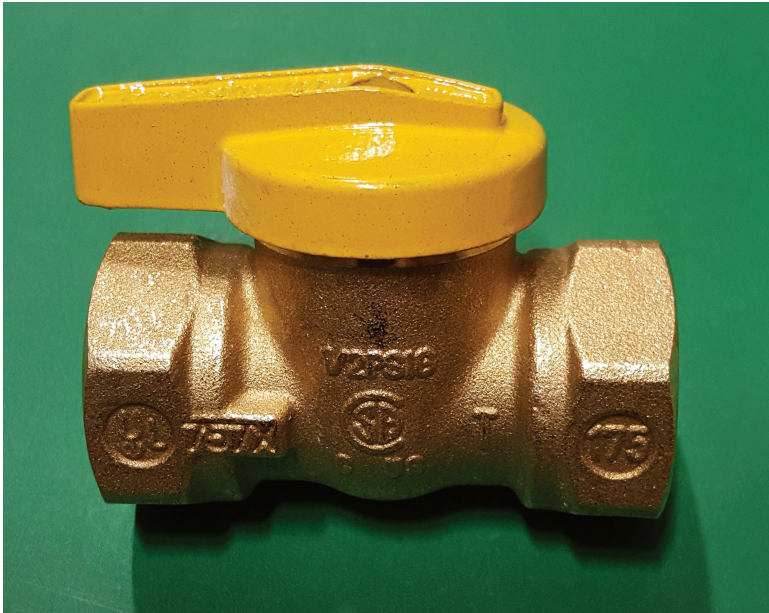

Gas Valve by Rosemary Rutherford is licensed under CC BY 4.0

Hose End Outlets

Various types of hose outlet connections are used in a plumbing piping system to drain equipment and systems and for water usage. The most common hose outlet designs are known as a hose bibb, wall hydrant, and boiler drain. Hose threads are different than pipe threads, and outlets are 3/4" male hose threads. A hose connection to a piping system is a primary point of entry of contaminants that pollute a water distribution system as a result of back siphoning also

known as backflow. Back siphoning can occur if a hose connected to a water supply pipe is placed into a contaminated source and the water system becomes depressurized.

Types of Hose End Outlets

Boiler Drain: A hose outlet connection that is designed to drain water heater storage tanks is known as a boiler drain. Boilers and water heaters are protected with other approved backflow devices, so most codes do not require a boiler drain to incorporate an integral backflow device in the design.



Boiler Drain by Gwen Arkin is licensed under CC BY 4.0

Hose Bibb: Hose bibbs are designed to allow water flow from a pressurized piping system. Some hose bibbs are similar to a boiler drain, and others are a freeze-proof type. Due to their potential to have contaminants enter the potable water system through them, most hose bibbs are required to be protected with a backflow device.



Hose Bib by Rosemary Rutherford is licensed under CC BY 4.0

Protective Valves and Devices

Many valves and devices react automatically to temperature and pressure differences or protect potable water systems from the reversal of flow within a piping system. Protective safety valves and devices can also regulate pressure, discharge high pressure, and discharge high temperature to protect system users and other plumbing system components.

Protective Valves and Devices and Their Uses



Pressure Regulator by Clifford Rutherford is licensed under CC BY 4.0

Pressure-reducing valve (PRV) or Pressure Regulator: Reduces

incoming water pressure. For municipal systems or community systems with a water meter, the incoming water supply pressure to a house depends on the design of the municipal or community system. While the optimal operational pressure for most household water supply systems is 40 to 80 pounds per square inch (psi), many municipal water system supply more than 100 psi or pressure to the residence. Excessive pressure in the water supply to a residence must be regulated to prevent pipes and fittings from bursting, and to protect valve seals and connected household appliances from damage due to high pressure. Codes typically allow the water service piping and hose faucets to exceed 80 psi, but piping that serves fixtures must be reduced to a maximum pressure of 80 psi. Most residential PRV styles have an adjustment range from 25 to 75 psi and are factory set to regulate water pressure to 50 psi and can be adjusted with a bolt/locking nut mechanism that reduces or increases the water pressure to the desired setting. An isolation valve should be installed upstream of PRV devices. PRVs are available in a variety of sizes, but 3/4" is the minimum size for reducing the main piping to a standard residence. To check the actual unregulated water pressure to a building, a simple water pressure gauge can be temporarily fitted with an adapter to an unregulated hose bib or faucet on the exterior of the building. Regulated pressure can be checked by adapting the same gauge to an interior faucet or washing machine supply valve.



Water Pressure Test Gauge by Gwen Arkin is licensed under CC BY 4.0

Relief valve: Relieves excessive pressure or temperature. Protecting a piping system and attached equipment from extreme temperatures and pressures is the responsibility of a relief valve. All relief valves are self-operating and open and close as they react to the various operating conditions of a system. Many dual-use relief valves provide protection against both temperature and pressure. These are known as T&P relief valves. Most codes require that a water heater be equipped with the proper T&P relief valves before being shipped. While valves used for water heaters on conventional and solar water heating incorporate a T&P valve in the tank design of water heaters, valves for pressure relief only are used on solar water heating panels. Pressure only style valves can be differentiated from T&P valves by the absence of a ceramic coated rod that normally protrudes from the T&P inlet.



Pressure Relief Valve by Gwen Arkin is licensed under CC BY 4.0

Check valve: Prevents the reverse flow of water or gas. Although check valves are a form of backflow-prevention devices, a single check valve is not an approved method to protect a potable water system from contamination. Swing and spring style check valves are the two most common installed for residential applications. They are installed to ensure the water, or gas, flows in one direction. The swing check style is more common for most water supply applications. The spring check is used more for gas supply and well pump systems.



Check Valves Swing, Spring & LP by Gwen Arkin is licensed under CC BY 4.0

Vacuum breaker: Prevents back siphoning. When a water distribution system is isolated or loses pressure, a vacuum is created and can allow contaminated water to enter a potable water system. To prevent the possibility of this type of contamination, vacuum breakers are installed throughout a piping system. Vacuum breakers are available in several forms.

Vacuum relief valve: Prevents back siphoning. Vacuum relief valves are type of vacuum breaker installed in the cold water piping that serves a water heater. This form of backflow prevention operates when sensing a loss of water pressure. It opens to create an atmospheric condition or to equalize the piping system with atmospheric pressure (zero gauge pressure).

Reduced pressure zone valve (RPZ): Prevents backflow. A reduced-pressure zone valve (RPZ) is the most reliable device installed in a plumbing system as a prevention method to stop the backflow of contaminated water from entering a potable water supply system. If water attempts to backflow in the system, it is discharged from the RPZ.



Reduced Pressure Zone Backflow Preventer by Gwen Arkin is licensed under CC BY 4.0

4.5 Faucets, Fixtures, & Fixture Drains

Plumbing codes require that every house must have at least one toilet, lavatory sink, bathtub or shower, and a kitchen sink. These, and some other items referred to in this chapter, are known as fixtures. Clearances from finished walls and other fixtures are strictly regulated by code and most fixtures are provided with a manufacturer rough-in sheet and installation instructions. Codes regulate the materials that are used to manufacture plumbing fixtures, which must have smooth, impervious surfaces and be defect free. Fixtures that incorporate porcelain enameled surfaces must be capable of withstanding acid without damaging the fixture.

Pay attention to flow rates, volume, and water usage in selecting fixtures. One key aspect of sustainability in plumbing focuses on water conservation. Lavatory faucets and shower heads are two primary focal points of conserving water. The true water saving aspect of a shower is based on duration of each use. A handheld shower can be equipped with mechanisms to turn off the water flow for certain showering activities, such as lathering.

Faucets

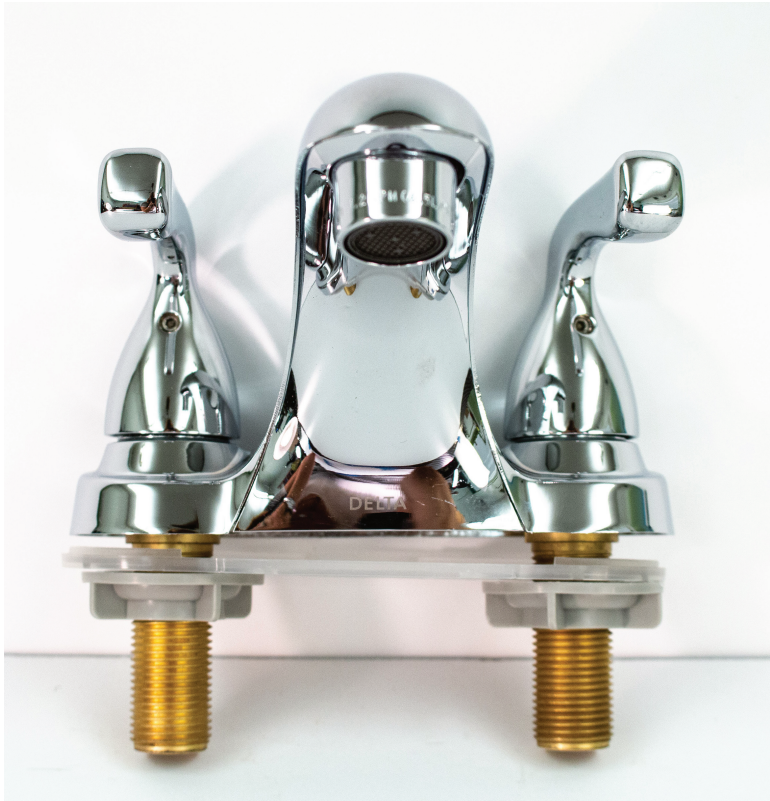

Lavatory with 2 handles by Gwen Arkin is licensed under CC BY 4.0

Selecting which manufacturer's product to install is based on cost, quality, and preferred faucet design which includes aesthetics, and functionality. Most master bathrooms and guest bathrooms have more expensive finishes than other bathrooms in a large house.

Faucet finishes dictate the finishes used for drain assemblies and bathroom accessories which creates a color theme. Faucet accessories are available to create various themes. Water conservation faucets have aerators that reduce the flow of water to allow only 0.5 gallons per minute as opposed to a 1.0 gallons per minute. Single-handle faucets blend the hot and cold water with the use of one handle; two-handle designs require a user to operate both handles to achieve a desired temperature.

Fixture	Single Handle	Two Handle	Three Handle
Kitchen Sink	Yes	Yes	No
Lavatory Sink	Yes	Yes	No
Bathtub	Yes	Yes	No
Large Capacity or Garden Tub	No	Yes	No
Shower	Yes	Yes	No
Tub & Shower	Yes	Yes	*Yes
Laundry Sink	No	Yes	No
Bidet	No	Yes	No

Faucet Installation

A faucet installed on a sink through a countertop or through a tub platform, instead of through the fixture itself, is considered a deck mounted faucet. All faucets must be designed to prevent backflow of wastewater into the water distribution system and plumbing codes require that a faucet have an air gap or be protected with a vacuum breaker or approved check valve. Most faucets use a tightening nut and flat washer to secure the faucet to a fixture. A bathtub and

shower faucet is usually installed during the rough-in phase of construction.

Faucet Water Supply: Connecting a water supply pipe to a faucet varies with the type of faucet and can be accomplished with many common connection methods. Some faucets connect to the water supply with male or female adapters to create a soldered connection, and others use a specially designed 3/8" OD supply tube that connects to the male threads of a faucet.

Fixture	Male Thread	Female Thread	Solder	3/8 Tubing
Kitchen	Yes	No	No	Yes
Lavatory	Yes	No	No	Yes
Bathtub	Yes	Yes	Yes	No
Large Capacity or Whirlpool Tub	Yes	No	No	No
Shower	Yes	Yes	Yes	No
Tub & Shower	Yes	Yes	Yes	No
Laundry	Yes	No	No	No
Bidet	Yes	No	No	Yes

Drain Assemblies

Drain assemblies are purchased based on the specific fixture they serve. Codes dictate the minimum drain size serving a particular fixture, and all fixtures and drain assemblies are manufactured based on minimum code requirements. A trap adapter is installed to connect the stubout pipe to the p-trap outlet. Most codes dictate that the largest size foreign object that can enter a drainage system is 1/2" diameter.

Fixture Types and Assemblies

Toilet

Toilets are also known as water closets. Residential toilets must be self-cleaning during their flushing cycle and have a toilet seat installed. Water conservation fixtures are rated at 1.6 gallons per flush (gpf) and 1.28 gpf. The most common residential toilet bowl design uses a siphon-jet flushing action. A tank handle activates a flushing cycle, and the water flows from the tank and enters the rim of the bowl. Small holes in the rim are angled to allow the water to create the vortex. The vortex (swirl) begins a siphoning action to evacuate waste from the bowl. The jet stream exits the rim and thrusts into the passageway of the toilet providing the initial thrust in the flushing process.

The water supply is located on the left side of all toilets. The stop and escutcheon are installed the same for a toilet as for other fixtures. The water is connected to a toilet using a tank supply. A tank supply is a chrome-plated soft copper tubing having a flat end that connects the stop to the fill valve. More modern supply lines are compression fit, plastic tube, with some having a braided stainless steel sleeve that protects the line from swelling and bursting. The toilet is installed onto the closet (toilet) flange and sealed with a wax ring. Some wax seals have a plastic accessory called a horn molded into the wax.

Toilet ADA Requirements: Handicap fixtures must comply with the Americans with Disabilities Act (ADA). The tank handle of an ADA-compliant toilet must be located on the side of the tank that has the greatest distance from a sidewall. A handle located on the top of a tank typically meets ADA handle location regulations. The height of a toilet bowl from the floor, which includes the seat, is regulated by

code. ADA codes dictate that the minimum height from a floor to a toilet seat is 16-1/2"; the maximum is 19-1/2".

Toilet Piping Locations: The outlet distance of a standard toilet is 12" from the finished wall located behind the toilet (back wall). Lesser used 10" and 14" rough toilets are available in some toilet designs. Typically, one-piece toilets have different water rough-in location requirements than two-piece toilets. When selecting a one-piece toilet, always request the manufacturer's data sheet, known as a roughin sheet, to confirm the water and drain pipes' installation locations.

Toilet Bowl Shapes & Seats: Residential toilets have round style bowls. Elongated bowls installed in many homes are usually considered a fixture upgrade. Codes require that an elongated (oval) bowl design be installed in commercial applications. When selecting an elongated bowl in place of a round bowl, be sure to check your local codes pertaining to the minimum clearance in front of a toilet. Codes require that commercial seats be an open front type and not have a lid.

How To Replace and Install a Toilet



An interactive or media element has been excluded from this version of the text. You can view it online here:
<http://pressbooks.oer.hawaii.edu/buildingmaint/?p=180>



An interactive or media element has been excluded from this version of the text. You can view it online here:
<http://pressbooks.oer.hawaii.edu/buildingmaint/?p=180>

Lavatory sink

Also known as a lavatory, lav, or basin. Many types, shapes, and colors are available. Many homebuilders install cultured marble solid surface countertops with pre-molded sink basins, so the plumber does not install a separate sink. Other models of lavatory sinks include drop-in, under-mount, and vessel (similar to bowl setting on the countertop fed by a separate counter mounted faucet). The stub-out piping serving a lavatory is either 1 - 1/4" or 1 -1/2". Most residential lavatories use a pop-up drain assembly. The overflow drain on a residential lavatory is an integral feature provided by the sink manufacturer.

- **Lavatory ADA Requirements:** Many lavatories are sold specifically for ADA compliance, but they are used more for commercial applications. ADA requirements require specific codes relating to the countertop height from the floor, the knee space under the sink, and the distances from the side and back walls.
- **Lavatory Styles:** Lavatory sinks are ordered based on shape, size, color, and mounting requirements, as well as the number of

faucet holes and the distance between them.

- **One-Piece:** Cultured marble or other approved material, incorporates the countertop and sink being formed as one unit.
 - **Drop-in:** A typical residential home utilizes a drop-in style lavatory that is either round or oval. A drop-in type lavatory sink requires a specific size hole cut into the countertop for the particular sink to be installed into the hole.
 - **Under Counter Mount:** Considered an upgrade, under counter mounted sinks attach to the underside of finish grade holes based on templates of the sink in granite, composite, and other hard countertops. While some of these sinks are secured with retaining clip, many rely on modern adhesive caulks to adhere them to the countertop and support their full weight during use.
 - **Pedestal:** A pedestal sink is a wall-hung sink with a decorative vertical leg known as a pedestal. The bowl is supported with brackets that are anchored to pieces of wood installed in the wall framing. The pedestal is not designed to be the sole support of the basin (bowl), but instead conceals the drain piping below the sink while providing a decorative styling.
- **Lavatory Faucets:** A lavatory faucet installs onto a plumbing fixture with various methods depending on the faucet type and manufacturer's design. They can be installed in either fixture mount style sinks or deck mount (through the countertop) applications. The standard, and most common, lavatory sink has a 4" hole spread between the hot and cold handles. The term spread refers to the distance between the hot and cold faucet inlets. The two most common handle designs are a single-handle and a two-handle faucet. The middle hole of a three-hole

lavatory sink is located in the center in the sink to receive the drainage operating assembly (pop-up) and/or a faucet spout connection.

- **Lavatory Drains:** The drain assembly for a lavatory faucet is known as a pop-up. The pop-up assembly consists of several different operating pieces that function as one unit. The pop-up rod is inserted through the faucet within the spout and connects to a linkage assembly below the sink that operates the pop-up plunger. All lavatory sink pop-up assemblies are 1 -1/4” tubular size. Most lavatories have an overflow port to eliminate water from rising over the rim of the fixture.

How To Install a Bathroom Vanity



An interactive or media element has been excluded from this version of the text. You can view it online here:
<http://pressbooks.oer.hawaii.edu/buildingmaint/?p=180>

Bathtub

Bathtubs are also known simply as tubs. A standard tub in a home is 5-0” in length and averages 30” wide. The depth of water a tub can hold varies with each specific tub design. Some tubs are sold separately, while others are sold with wall kits as a one-piece tub and shower unit or with various whirlpool features. A one-piece tub

and shower unit is a fiberglass tub molded with the walls as a single unit. A tub is typically installed during the rough-in phase of a project. However, some drop-in style tubs, whirlpool tubs, and large-capacity garden tubs, are installed on top of tile or other solid surface are installed after the finished surface is complete.

The drain location is typically on one end of the tub that is known as the head wall. This is usually the same wall where the faucet is located and tubs are selected based on a left-hand or right-hand head wall design. The bottom surface of a tub slopes toward the drain. Every tub has an overflow hole (port) where a waste and overflow is installed.

- **Bathtub Faucets:** A tub faucet is intended to fill a tub. A tub faucet can either be deck-mounted or installed in a wall. Deck-mounted faucets are common for large-capacity tubs and whirlpool tubs. A faucet serving a tub or a shower is commonly referred to as a tub valve. Tub/shower valves can be used for tubs without a shower by installing a plug or cap in the shower riser port.
- **Tub & Shower Faucets:** A tub and shower combination faucet is capable of providing water for bathing or showering with the use of a diverter. Many different designs are available to divert the water flowing through a tub spout to flow through a showerhead. Diversion methods of a single-handle tub and shower faucet use either a diverter style tub spout or a push button diverter usually located directly below the faucet handle. A three-handle Tub and shower faucet design uses the middle handle as the diverter.
- **Bathtub Drains:** A bathtub drain assembly is called a bath waste and overflow (BW&O). A bathtub has an overflow port hole and a drain port that are always connected and installed as a pair (usually aligned with each other). Large capacity whirlpool tubs are more likely to have the holes in varying locations than a

standard bathtub.

Installing a 1-Handle Posi-Temp Shower Valve: Copper to Copper



An interactive or media element has been excluded from this version of the text. You can view it online here:
<http://pressbooks.oer.hawaii.edu/buildingmaint/?p=180>

Installation – Sterling Ensemble Medley



An interactive or media element has been excluded from this version of the text. You can view it online here:
<http://pressbooks.oer.hawaii.edu/buildingmaint/?p=180>

Shower

Not part of a tub and shower combination.

- **Shower ADA Requirements:** ADA-compliant shower bases have a lower or no threshold and a larger square foot area than a typical non-handicap shower base. Many shower designs use a

seat within the shower, and most handicap shower designs must have a seat. If a seat is constructed in a tiled shower on a wood floor, the plumber must provide waterproofing (ex: PVC liner) to the seat as well as the shower base. One-piece shower units that have a seat are typically premolded into the design of the shower.

- **Shower Faucets:** A shower faucet is intended to serve a shower head. Shower faucets and tub valves are interchangeable, however a combination tub/shower valve that does not incorporate an integrated diverter may be used with the tub port plugged or capped.
- **Shower Drains:** A shower base constructed on a wooden, and sometimes concrete, floor prepared to be covered with ceramic tile requires a safety pan. Most safety pans use a polyvinyl chloride (PVC) liner. A three-piece shower drain is required to ensure that water does not seep around the drain. The threaded top portion is adjustable to allow various tile thicknesses. The middle portion receives the top threaded portion and is bolted to the bottom portion. The bottom portion rests flush with the wood floor and connects the piping to the p-trap.

Oatey Shower Pan Liner Installation



An interactive or media element has been excluded from this version of the text. You can view it online here:

<http://pressbooks.oer.hawaii.edu/buildingmaint/?p=180>

Kitchen sink

The most common residential kitchen sinks have either a single bowl or a double bowl. Most kitchen sinks are surface mounted and are installed into a countertop during the trim-out phase of construction. Surface-mounted sinks are also known as self-rimming sinks and typically have holes for installing the faucet directly onto the sink. Solid surface countertops can utilize a sink mounted from under the countertop and incorporate deck mounted faucets. The common types of kitchen sinks used in residential construction are stainless steel and cast iron. The weight of a cast iron sink provides the necessary stability to maintain its permanent position on the countertop and does not require retainer clips when installed with an appropriate adhesive caulk. A plumber applies caulking to the edge of the cutout area of the countertop and places the cast iron sink into the hole. A stainless steel sink requires the sink to be fastened to the countertop using fastening clips provided. A kitchen sink can also serve a garbage disposal and dishwasher

- **Kitchen Faucets:** A kitchen faucet is usually installed before installing a kitchen sink. A kitchen faucet has a swivel spout that allows the water flow to be used in each bowl of a kitchen sink. The most common type of kitchen faucet requires a sink to have three faucet holes that are 4" apart or 8" from the hot and cold water supply connections to the faucet. Most kitchen sinks are offered as a three-hole design, but many popular faucet designs have a pull-out spout that is also the spray unit. If a separate handheld sprayer is used, a four-hole model sink must be selected. Most pull-out spout faucets are manufactured with an integral check valve. The center hole of a three-hole sink is normally aligned with the center of the sink.
- **Kitchen Sink Drains:** The drainage system serving a kitchen

sink is connected to the fixture with a basket strainer. Regardless of the type or style of kitchen sink, the connection of the drainage system is the same, and all have 1 -1/2" drain connections. A rubber gasket is placed over the basket strainer from under the sink. A fiber (cardboard)-type gasket is placed between the tightening nut and rubber gasket.

Delta Faucets-How to Install a Single Handle Kitchen Faucet



An interactive or media element has been excluded from this version of the text. You can view it online here:
<http://pressbooks.oer.hawaii.edu/buildingmaint/?p=180>

Installing a Pfister 2-Handle Kitchen Faucet with a Sidespray – Harbor Collection



An interactive or media element has been excluded from this version of the text. You can view it online here:
<http://pressbooks.oer.hawaii.edu/buildingmaint/?p=180>

How-to Install a Stainless Steel Drop-In Sink | Moen Installation Video



An interactive or media element has been excluded from this version of the text. You can view it online here:
<http://pressbooks.oer.hawaii.edu/buildingmaint/?p=180>

How-to Install a Stainless Steel Undermount Kitchen Sink | Moen Installation



An interactive or media element has been excluded from this version of the text. You can view it online here:
<http://pressbooks.oer.hawaii.edu/buildingmaint/?p=180>

Laundry Sink

Also known as a laundry tray or utility sink. They are typically installed in the same room as a washing machine, or in a garage or workshop. Two most common types of laundry sink designs are wall mounted, which requires a plumber to install wood backing in the wall during the rough-in and a hanger bracket installed during trim-out; or with the four legs secured to the floor which requires a drill to install anchors into the floor.

- **Laundry Sink Faucets:** Laundry tub faucets usually have a 4" spread design and most laundry sink faucets have a swivel spout. Some laundry sink faucets have a hose thread on the outlet portion of a spout to allow a garden hose to be connected. For a hose-end spout to be legally installed, it must have a vacuum breaker to prevent backflow into the potable water supply.
- **Laundry Sink Drains:** The minimum size drain allowed by code to serve a laundry sink is 1 -1/2". Most quality types of laundry sink basket strainers have a removable strainer. Because a laundry sink can receive discharge from a washing machine, a removable strainer should be installed.

How to Install the UTILATUB® Laundry/Utility Tub



An interactive or media element has been excluded from this version of the text. You can view it online here:
<http://pressbooks.oer.hawaii.edu/buildingmaint/?p=180>

Bidet

A bidet is a personal hygiene fixture that is usually matched in style and color with, and placed adjacent to, a toilet. A bidet's faucet and drain assembly are sold based on the fixture design and typically sold as a pair with the toilet. The water supply must be protected against

backflow with a vacuum breaker assembly. The water supply serving a bidet is typically a 3/8" supply tube similar to a lavatory. The base of a bidet, like a toilet, typically has two mounting holes to anchor the bidet to the floor.

- **Bidet Faucets:** A bidet faucet must be compatible with the fixture based on the faucet hole design for installing a particular faucet and a vacuum breaker if required. A vacuum breaker is required by code if the hygiene sprayer is located in the bowl area of a bidet because it is below the flood level rim of the bidet.
- **Bidet Drains:** A bidet's drain assembly is very similar to a lavatory's pop-up assembly. Most bidets that use vacuum breakers have a dedicated hole in the fixture while others are served with the backflow device installed in the piping system.

4.6 Plumbing for Appliances

Appliances are a vital part of a functioning residential dwelling, and some appliances connect to plumbing systems. Some appliances require a plumber to install the piping systems during the rough-in phase of construction, while other appliances are installed by a plumber during the trim-out phase of construction.

PLUMBING CONNECTIONS FOR APPLIANCES

APPLIANCE	COLD WATER	HOT WATER	DRAIN
Garbage Disposal	No	No	No
Dishwasher	No	Yes	Yes
Icemaker	Yes	No	No
Washing Machine	Yes	Yes	Yes

Dishwashers

A plumber normally installs a dishwasher during the trim-out phase of construction, typically at the same time as the sink and garbage disposer. A dishwasher receives hot water from the same water source that serves the kitchen sink. Many codes require that a dishwasher drain hose be routed through an air gap device to prevent wastewater from flowing from the sink into the dishwasher.

The water supply piping to a dishwasher is typically 3/8" OD

tubing, with the hot water supply routed from under the kitchen sink. The drain hose from the dishwasher connects to either a dedicated connection of a garbage disposer or tailpiece. A dishwasher has leveling legs that can be adjusted to accommodate the opening height from the floor to the underside of the dishwasher.

Although dishwashers can connect to a kitchen sink drain with a special “Wye” fitting, most dishwashers discharge through garbage disposals at a designated dishwasher connection located on the side of a disposer. If a hose end is not compatible with the garbage disposer, a boot is used for the connection. A rubber dishwasher boot requires a small piece of copper to be inserted into the boot and the dishwasher hose, and then all connections are sealed with hose clamps.

Whirlpool Dishwasher Removal and Installation



An interactive or media element has been excluded from this version of the text. You can view it online here:
<http://pressbooks.oer.hawaii.edu/buildingmaint/?p=183>

Garbage Disposers

A garbage disposer is a motorized appliance that is activated manually with electrical current. It has an internal rotating flywheel to shred food waste which is discharged into the drainage system. The horsepower of the motor determines the capabilities

of the garbage disposer. The most common HP sizes for residential applications range from 1/3" to 3/4". A garbage disposer is commonly installed in a kitchen sink with a specially designed mounting assembly where a basket strainer would normally be installed. This multi-piece assembly consists of a sink flange that is inserted and sealed into the sink drain outlet where a basket strainer would normally be installed. The rubber gasket creating the seal between the disposer and the mounting assembly also serves as a noise reduction item. A garbage disposer has a designated port to accept the dishwasher drain hose.

Biodegradable products can be added to a septic tank to stimulate the decomposition of food waste within the septic tank. If a homeowner does not add the biodegradable solution, the food waste will settle to the bottom of the tank.

How to Install / Remove a Garbage Disposal – InSinkErator



An interactive or media element has been excluded from this version of the text. You can view it online here:
<http://pressbooks.oer.hawaii.edu/buildingmaint/?p=183>

Garbage Disposal Repair | How to Fix a Garbage Disposal – InSinkErator



An interactive or media element has been

excluded from this version of the text. You can view it online here:

<http://pressbooks.oer.hawaii.edu/buildingmaint/?p=183>

Reset the Overload Protector on InSinkErator Garbage Disposal



An interactive or media element has been excluded from this version of the text. You can view it online here:

<http://pressbooks.oer.hawaii.edu/buildingmaint/?p=183>

Washing Machine Boxes

A washing machine box is used to provide hot water, cold water, and a drain connection in one central location. Most codes also require that the smallest size water supply that can be installed serving a washing machine is 1/2" (5/8"OD). Hose end style valves are integrated into the box's design to provide hot and cold supply water to the washing machine. Traditional stops with rubber washers are common in residential applications, but 1/4 turn ball valve stops are becoming more commonly used by contractors and over time are more reliable. A typical residential washing machine box is manufactured to be recessed in a wall cavity with a hub to receive 2" plastic pipe because

most codes dictate that the minimum size drain that can be installed serving a washing machine is 2”.

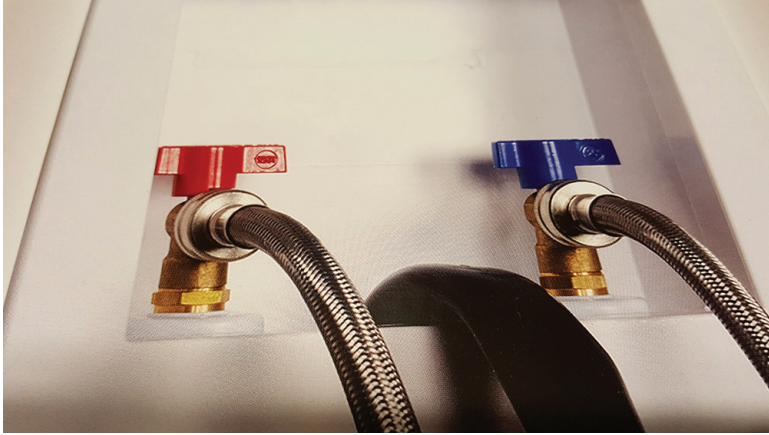

Washer Box by Clifford Rutherford is licensed under CC BY 4.0

Icemaker Boxes

A plumber routes the cold water piping to the refrigerator area and installs an icemaker box as the termination point of the potable water supply. The box is installed between two vertical wood studs and near the floor during the rough-in phase of construction. A plumber installs 1/2” pipe to the icemaker box and connects the piping to the angle valve provided with the box. The outlet of the valve that is purchased with the box has a 1/4” OD compression connection to allow the compatible tubing of the refrigerator to connect with the icemaker valve.

4.7 Water Heating

Conventional Water Heating Systems

The most common residential water heater has a 40 or 50 gallon storage tank capacity. They are available in electric, natural gas, and propane (LPG) models. The height and diameter of a water heater varies with the gallon capacity. When selecting water heaters, it is important to know the measurements of the space the appliance will occupy, and to check the water heater manufacturer specifications and codes for space requirements for ventilation, clearances, and other installation requirements. The shorter versions water heaters are known as a “low-boy”. that can fit in closet spaces or under stairs, or as a “squat” water heater that can fit under countertops. Squat water heaters are generally offered in electric configurations ranging from 5 to 40 gallons, and gas is not used due to ventilation and carbon monoxide concerns.

All water heaters must be installed per local codes and manufacturer instructions:

- An isolation valve must be installed on the cold water piping near the inlet.
- A typical residential water heater has 3/4” male or female threaded water supply connections.
- Most codes dictate that any water heater located above a finished area must be installed in a safety pan.
- Most relief valve connections of a residential water heater are 3/4” female and require a plumber to install a 3/4” male adapter.

Electric Water Heaters

An electric water heater only requires a plumber to connect the hot and cold water piping from the rough-in stub-outs to the designated inlet and outlet connection. They do not require venting or gas piping and are less expensive to purchase. Most codes allow the safety pan for an electric water heater to be plastic due to the lack of heat generated externally from the water heater in comparison to gas fired models.

A standard residential electric water heater is classified as a 240-volt, 4500-watt, non-simultaneous water heater. Models with faster recovery rates may have higher wattage elements. The higher the wattage rating, the faster a water heater can heat water. Although most electric water heaters have two elements, each rated at 4500 watts, a non-simultaneous heating cycle has only one of the elements operating at a time. Each wire providing electricity to a water heater is known as a leg. The two different wires (legs) that connect to the high-limit device are identified as line voltage one and two. One wire eventually provides 120 volts of electricity to one side of a heating element and the second wire eventually completes the circuit by providing an additional 120 volts to the same element. The screws that secure the wire connection to the electrical devices are known as terminations, poles, or posts.

No water heater should ever have the ignited gas or electricity energized before filling the system with water and removing all trapped air from the system.

Electric Water Heater Components and Their Functions

Temperature and Pressure (T & P) Relief Valve- Electric, gas & solar applications, relieves at 150 psig and/or 210° F. (Temperature (only) relief valves are used on the rooftop collector panels of solar water systems).

Mythbusters- water heater



An interactive or media element has been excluded from this version of the text. You can view it online here:
<http://pressbooks.oer.hawaii.edu/buildingmaint/?p=186>

Dip Tube- As heat rises, and the outlet supply of hot water to the fixtures feeds from the hottest point at the top of the water heater, manufacturer install a device known as a dip tube into the cold water connection of a top-fed water heater to route the incoming cold water to the bottom of the heater. If a dip tube were not used, the incoming cold water would mix with the hot water located in the top of the water heater, cooling the exiting water during use.

Drain- Used to flush the water heater's storage tank during maintenance.

Ball valve- Used to shut off the supply water to the tank.

Mixing Valve- Allows cold water to enter hot water stream to temper over-temp water to prevent scalding. Mixing valves are

normally required to be installed on solar water heating systems as temperatures can potentially reach in excess of 160°.

Tank Anode Rod- A residential water heater storage tank is manufactured with carbon steel, with most common residential water heaters incorporating a very thin coat of porcelain enamel called a “glass” lining, designed to fill every internal crevice created by the manufacturing process of the tank, to prevent the carbon steel tank from corroding. However, over time, this lining breaks down and the steel tank begins to corrode. An anode rod is a sacrificial device that dissolves (corrodes) over a period of time. An anode rod is installed by the manufacturer to prevent from rusting and corrosion of the inside of the tank due to glass lining imperfections or minor damage during shipping and handling. Magnesium-based and aluminum rods are more vulnerable to rust and minerals that would normally attack the steel walls of a tank and attract corrosives to attack the anode rod instead of the tank.



New versus Expended Anode Rod by Cory Early is licensed under CC BY 4.0

Top Access Cover- The thermostat and the red button are located in here. The upper heating element is also found here.

Bottom Access Cover- The lower thermostat and heating element are located here.

Upper Thermostat- Limits the temperature that the element will heat the water up to. Both, upper and lower, thermostats are secured in place and held against the surface of the tank with a retainer clip, keeping the thermostat in contact with the external portion of the storage tank. Most safety standards do not allow a plumber to set the temperature above 120 degrees Fahrenheit to prevent scalding. The upper thermostat of a seven-pole design only has three posts. This three-post design combined with the four posts of the high limit switch is how the seven-pole design is recognized. The upper thermostat has a temperature setting feature that is typically either identified alphabetically from A through D, or identified as warm, hot, and very hot.

Replacing Upper Thermostat



An interactive or media element has been excluded from this version of the text. You can view it online here:
<http://pressbooks.oer.hawaii.edu/buildingmaint/?p=186>

Lower Thermostat- The lower thermostat only has two posts and numbered 1 and 2. It also has a temperature setting feature that is the same design as the upper thermostat. Like the upper thermostat,

lower thermostats can be adjustable and have similarly marked adjustment points.

Hi-Limit Device (Red Button Over Temperature Thermostat)-

The high-limit device halts the electrical current to the thermostats and elements if an unsafe water temperature is present. Most high-limit devices have a reset button designed to pop out if the temperature reaches 190°. These devices can be reset once the temperature of the tank cools below the “pop-off” temperature.

Heating Element- Elements convert electrical energy to heat energy and transfer heat to the water in the tank. They are rated in watts and selected for tanks according to tank size and recovery rate. Residential electric water heating elements are usually a screw-in type, but bolt-in types are used for certain water heater models. The elements can vary in length, with 12” being the typical length provided by a manufacturer in most water heaters. The electrical voltage and wattage ratings of the element are indicated by a manufacturer on the element so its identification of replacement parts specifications is available on the exterior.

Lined and Dielectric Pipe Nipples- Many water heaters are manufactured with pipe nipples that are lined with corrosive-resistant material such as PEX. These pipe nipples are manufactured to resist corrosion due to electrolysis from joining dissimilar metals to the iron tank (copper to iron = rust). Brass pipe fittings can also be used between iron pipe fittings and copper to resist electrolysis. A plumber must take precautions when connecting copper tube to a lined nipple as heating the lining of the pipe nipple directly with a torch or by connecting a fitting that has been soldered and not allowed to cool can melt the internal lining of the nipple. Brass to copper unions provide the same benefit in non-concealed applications.

Expansion Tank- Every water heating system must be protected against dangerous occurrences that exist when water is heated. As a heating cycle occurs, water expands and can cause the pressure

relief valve to begin dripping. Expansion tanks are installed, mainly in solar water systems, to absorb the expansion of a system. An expansion tank used for a potable hot water system has an internal rubber membrane known as a bladder. Most codes require that an expansion tank be installed near a water heater to protect the piping system from high pressure caused by the heating cycle.

GAS WATER HEATERS

Natural gas and propane (LPG) are the two types of gas used for water heating. A water heater designed for natural gas cannot be used with propane unless the particular water heater can be converted. The internal gas regulating orifice is different for each type of gas. The venting requirements of a gas water heater are dictated by code. The exhaust fumes from a gas water heater contain carbon monoxide. Carbon monoxide fumes are odorless and can kill occupants of a home or building. Conventional gas water heaters are vented atmospherically, that is, to the exterior of the building. Atmospheric water heater venting must terminate in specific locations through, and heights above a roof. Gas water heaters must have adequate space around the water heater and replacement air to create proper draft conditions that allow the fumes to be exhausted to the exterior of the building. If adequate air is not provided in the room where an atmospheric vented water heater is located, the exhaust fumes could enter the occupied space.

Selecting a gas water heater based on its capabilities requires manufacturer's specifications for the specific appliance and knowledge of the load demand. The recovery rate is the most important aspect of determining if a certain gas water heater is capable of being installed for a specific home or use. Gas water heaters are rated by the gallons of hot water they can produce. One **British Thermal Unit (BTU)** is the amount of heat required

to raise one pound of water by one degree Fahrenheit. One gallon of water weighs 8.33 pounds, and 8.33 btus are required to raise the temperature of one gallon of water by one degree Fahrenheit. **Temperature rise** is the difference between the incoming cold water and the desired temperature expected from a water heater. Temperature rise determines the capabilities of a certain Btu rating of a gas water heater. A length of time is used to clarify the recovery capabilities of a gas water heater, and **gallons per hour (gph)** is the most common method used in rating a hot water heater.

- Codes vary pertaining to the gas supply connections and venting regulations.
- A gas water heater uses a metal safety pan.
- The gas supply configuration is fairly consistent with most residential water heaters: black iron pipe or approved polyurethane tubing, brass fittings, gas-cock, flex supply line, and regulator

Gas Regulators

A gas regulator is an automated device that controls the gas flow to a burner assembly. The gas supply pipe is connected to the gas regulator which regulates the flow of gas to the burner. A thermocouple must sense a pilot flame in order to allow the gas to flow through a gas regulator. The design of a gas regulator is based on safety, and most codes do not allow anyone not certified to repair a gas regulator to disassemble one for repair. Another feature of the regulator is to control the gas flow to a pilot flame. The gas regulator for a residential gas water heater typically has a 1/2" female threaded connection.



An interactive or media element has been excluded from this version of the text. You can view it online here:
<http://pressbooks.oer.hawaii.edu/buildingmaint/?p=186>

Tankless Water Heaters

A tankless heater design can be suitable for many residential applications. Water flow is regulated to ensure that the desired temperature leaves the heater. They are becoming more desirable and are considered environmentally friendly. Tankless models are also known as an instantaneous water heaters.

The two basic types of tankless water heaters are interior or exterior, defining whether the installation location is inside or outside of the building structure. Tankless water heaters are available in electric models for interior applications. Tankless water heaters can be installed inside or outside a building, but units installed outside must be gas. The units are not interchangeable. Interior units require venting of the flue gas and exterior units may require freeze protection in certain climates.

Solar Water Heaters

Although a solar thermal water heating system can save a residence up to a 40% savings on utility bills, the initial investment to install a solar water heating system may deter many homeowners. Federal, and sometimes state, tax credits are available for installing alternate energy systems and utility savings over time are a good return on investment (ROI).

Solar water systems use solar collector panels, usually mounted on the roof to heat the system water. When the temperature of the water in the collector reaches a specific higher temperature than the water in the tank, a pump circulates the cooler water from the tank which pushes the hotter water in the roof panel back into the tank until the temperature of the panel and the temperature in the tank are equal.

The location and angle of the solar panel (orientation and tilt for optimal sun exposure) is crucial to obtaining optimal efficiency of the entire system. Most solar systems are directly connected to gas or a single electric heating element to provide adequate hot water during non-solar heating periods.

Diagnosing Common Water Heater Problems

Water heaters should be flushed annually to remove contaminants and scale from the tank. Anode rod should be inspected every 2 years and replaced approximately every 5 years, or sooner if conditions show significant corrosion of the rod. Troubleshooting gas and electric water heaters must be performed by qualified individuals. Basic electrical knowledge must be known to safely troubleshoot an electric water heater, and a plumber must have an electrical voltage/

amperage meter to diagnose and service an electric water heater. Always remember that a water heater must be always be filled with water before igniting the gas supply or electrically energizing the system and only a certified technician can repair gas regulators.

Electric Water Heater Diagnostics

SYMPTOM	POSSIBLE CAUSE	POSSIBLE SOLUTION
No hot water	No electricity from source	Check breaker
No hot water	Electrical problems with thermostats	Test and replace appropriate thermostat/s
No hot water	Failed heating element(s)	Test and replace appropriate element/s
Little hot water	Dip tube failure	Inspect dip tube and replace if necessary
Little hot water	Lower thermostat or element failure	Replace lower thermostat and/or element
Little hot water	Thermostat/s failure	Test and replace appropriate thermostat/s
Water too hot	Thermostat/s failure	Test and replace appropriate thermostat/s
Reset button tripped	Water too hot	Test and replace appropriate thermostat/s
Rotten egg smell of water	Expended anode rod	Inspect and replace
Popping noise when heating	Scale build-up on element(s)	Replace element(s)



An interactive or media element has been excluded from this version of the text. You can view it online here:
<http://pressbooks.oer.hawaii.edu/buildingmaint/?p=186>

HEATING ELEMENT DIAGNOSTIC PROCEDURE

1. **Switch off the power** to the water heater at the main electrical panel.
2. Locate the electrical access panels, one near the base of the tank and one nearer the top (solar water systems only have one back-up element and thermostat located in the upper access). Beginning with the top element, remove the panel's screws with a screwdriver. Take off the panel and remove insulation behind it to uncover the heating element.
3. Disconnect either of the two electrical wires screwed into the element terminals. It is not necessary to disconnect both wires to test the element.
4. Set the multimeter or Ohmmeter to read Ohms, and set the scale to RX1. Touch one probe to each of the two terminal screws. If the needle moves at all, or if there is any reading besides "infinity" on a digital readout, the element is good. If it doesn't move, or displays "infinity," no electricity is flowing through the element and it should be replaced.
5. Complete replacement or repairs as necessary. Reconnect the wire to the element terminal. Replace the insulation and reinstall the access panel.
6. Repeat the process on the bottom element. Restore power to

the water heater from the main electrical panel.

How to Replace an Electric Water Heater Heating Element



An interactive or media element has been excluded from this version of the text. You can view it online here:
<http://pressbooks.oer.hawaii.edu/buildingmaint/?p=186>

Gas Water Heater Diagnostics

SYMPTOM	POSSIBLE CAUSE	POSSIBLE SOLUTION
No gas to pilot	No gas from meter or gas cock	Turned off at meter or gas cock
No gas to pilot	No gas from regulator	Debris in regulator. Clean or replace defective regulator
No gas to pilot	Faulty regulator	Replace regulator
No gas to pilot	Crimped pilot tube	Repair or replace tube
No gas to pilot	Leak in pilot tube	Replace tube
No pilot flame	No gas flow from regulator	Debris in regulator. Clean or replace defective regulator
No pilot flame	Defective thermocouple	Replace thermocouple
No pilot flame	Air in gas piping	Purge air from piping
No gas to burner	Defective regulator	Replace regulator
No gas to burner	Crimped burner tube	Repair or replace burner tube
No gas to burner	Blockage in burner tube	Remove tube and clean
No gas to burner	Remove and clean	Run water to cool tank
No gas to burner	Defective high-limit device	Replace device or regulator
Temperature and Pressure (T&P) relief valve leaking	Water is too hot	Run water to cool tank
Temperature and Pressure (T&P) relief valve leaking	Defective relief valve	Replace relief valve
Temperature and Pressure (T&P) relief valve leaking	Excessive pressure	Install expansion tank
Temperature and Pressure (T&P) relief valve leaking	Excessive pressure	Check pressure regulator valve to system supply

SYMPTOM	POSSIBLE CAUSE	POSSIBLE SOLUTION
Low water temperature	Thermostat set too low	Adjust temperature setting on thermostat
Low water temperature	Dip tube failure	Inspect and replace if necessary
Low water temperature	Defective thermostat	Test and replace appropriate thermostat/s
Slow recovery time	Sediment in tank	Drain and flush tank
Slow recovery time	Dirty burner assembly	Clean burner assembly
Slow recovery time	Poor flame	Adjust burner air supply
Slow recovery time	Poor flame	Supply more combustion air
Not enough hot water	Insufficient size heater	Calculate demand load and replace with an appropriate sized water heating system
Not enough hot water	See low water temperature and slow recovery symptoms	See low water temperature and slow recovery symptoms
Popping / banging noises	Calcium or sediment build up	Drain and flush tank
Banging noise	Check valve slamming when a faucet or valve is being opened or closed	Install a shock absorbing device
Fume odor	Poor draft on flue system	Examine flue pipe installation and ensure termination location provides sufficient draft
Gas odor	Leak on piping system	Soap test all piping joints and supply lines for leaks and repair as required
Soot build up	Poor draft on flue system	See fume odor, install a draft hood fan
Soot build up	Insufficient combustion air	Install air supply ducts or vents

SYMPTOM	POSSIBLE CAUSE	POSSIBLE SOLUTION
Soot build up	Poor burner flame	Clean and adjust burner
Flame back flash	Negative air pressure	Isolate heater air

PART 5: ELECTRICAL SYSTEMS

Electrical Systems

ELECTRICIAN APPRENTICESHIP, EXPERIENCE, AND EDUCATION REQUIREMENTS

Most states and municipalities require electrical workers to be licensed.

HAWAII REQUIREMENTS:

i) Provide verification of the following:

- Journey Worker Electrician (EJ)- 5 years but not less than 10,000 hours in residential or commercial wiring and satisfactory completion accepted by a University of Hawaii Community College offering an appropriate program of study of 240 hours of electrical academic coursework.
- Supervising Electrician (ES)- 4 years experience as a licensed journey worker electrician or equivalent.
- Journey Worker Industrial Electrician (EJI)- 4 years but not less than 8,000 hours and satisfactory completion accepted by a University of Hawaii
- Community College offering an appropriate program of study of 200 hours of electrical academic coursework.
- Supervising Industrial Electrician (ESI)- 3 years experience as a licensed journey worker industrial electrician or equivalent.
- Journey Worker Specialty Electrician (EJS)- 3 years but not less

than 6,000 hours and satisfactory completion accepted by a University of Hawaii Community College offering an appropriate program of study of 120 hours of electrical academic coursework.

- Supervising Specialty Electrician (ESS)- 2 years experience as a licensed journey worker specialty electrician or equivalent.
- Maintenance Electrician (EM)- 1 year electrical maintenance wiring and satisfactory completion accepted by a University of Hawaii Community College offering an appropriate program of study of 80 hours of electrical academic coursework or 2 years of schooling in the trade with not less than 1,000 hours of hands-on lab exercises.

2) Pass the Board's examination

(Reference: http://files.hawaii.gov/dcca/pvl/faqs/electrician_plumber_faq.pdf)

LICENSE RENEWAL

Prior to every license renewal, all licensed plumbers must meet continued competency requirements to renew their license:

“The licensee shall submit (1) a copy of a certificate from a University of Hawaii Community College evidencing attendance at an update course of the “NEC” or (2) a copy of a score report from Prometric verifying successful passage of the continued competency exam on the updates to the “NEC””

Electrical Codes

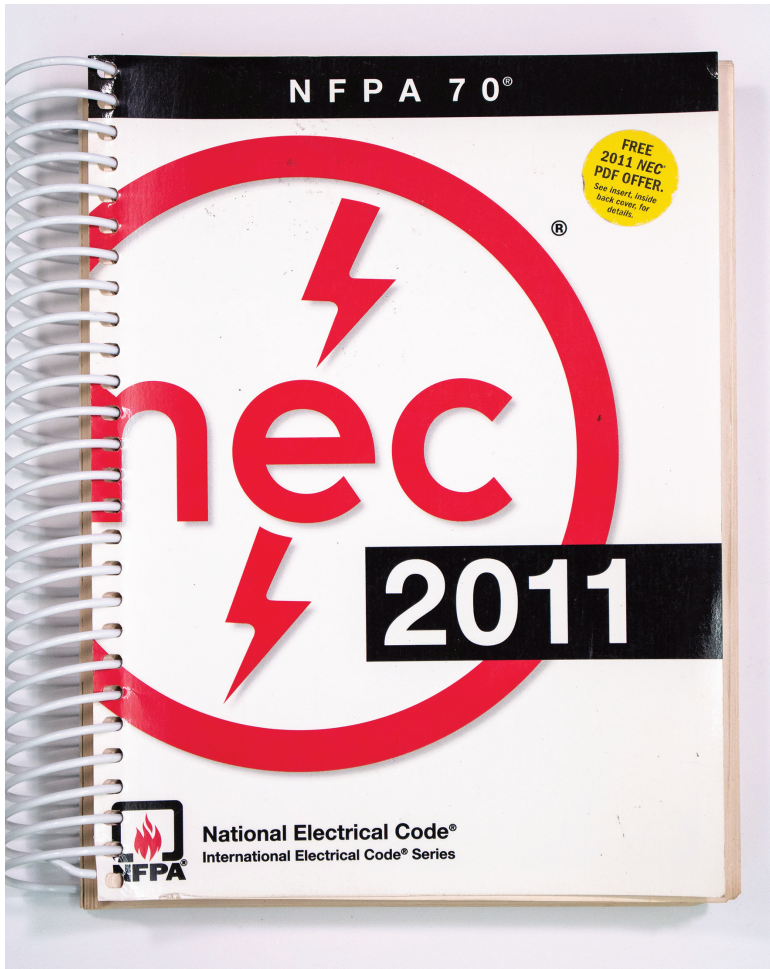

NEC 2011 Code Book by Gwen Arkin is licensed under CC BY 4.0

The National Electric Code (NEC)

- Published every 3 years by the National Fire Protection Association (NFPA)
- Not a federal law
- Regionally adoptable by states and municipalities
- Adopted in all 50 states
- Most jurisdictions do not immediately adopt new additions.
- As of April 2017, Maui County still uses the 2011 edition of the NEC to enforce safe practices

Electrical wiring for residential and commercial applications has specific electrical and building code requirements and should be done only by a licensed professional. The following information is presented for educational purposes only.

5.1 Electrical Safety

Electrical Safety Considerations

Electrical Shock

Electricity flows along a circuit that consists of a power source, a load, and conductors. The human body can become a conductor and a part of the electric circuit which can result in electrical shock. Exposure to electrical energy may result in no injury at all or may result in physical and/or neurological damage or death. An minor electrical shock may cause muscle pain and may trigger mild muscle contractions or startle people, causing a fall. However, high resistance contact may cause dielectric breakdown at the skin, lowering skin resistance, causing surface damage, but more often tissues deeper underneath the skin have been severely damaged. Electric shocks can paralyze the respiratory system or disrupt heart action, causing instant death.

The outcome of an electrical shock depends on several factors that are determined by the relationship between current, voltage, and resistance, also known as Ohm's Law.

Ohm's Law

Voltage or Electrical Force (V)

Amperage or Current Flow (I)

Resistance or Ohms (Ω or R)

CURRENT=ELECTRICAL FORCE/RESISTANCE OR $I=V/R$

Exposure Conditions play an important role in the extent of injuries sustained as a result of electric shock. These factors include:

- **Duration-** The longer a human body remains part of an electrical circuit, more tissue and neurological damage can occur.
- **Pathway-** Electricity is always seeking the path of least resistance to ground. If both hands of a person are part of the pathway, the current has more potential to affect the heart resulting in ventricular fibrillation. If the current chooses another path such as hand-to-foot, tissue and internal organ damage still may occur.
- **Humidity/Saturation-** Electricity can easily flow through water or moisture in the air. Humidity also can effect how much a body sweats, which can lower a persons resistance to electrical current.
- **Skin Condition-** The human body's resistance to current is affected moisture content:
 - Dry Skin- 100,000 to 500,000 ohms of resistance
 - Perspiring (sweaty hands)- 1000 ohms of resistance
 - In Water (completely wet)- 150 ohms of resistance

Amperage Kills

Current	Effect
<1 Milliampere	No sensation
1 Milliampere	Tingling sensation
5 Milliamperes	Slight shock felt
6 to 30 Milliamperes	Definite shock Could cause muscle contraction causing you to hang on
50 to 100 Milliamperes	Painful shock Breathing can stop Severe muscle contractions Possible death
1000 to 4300 Milliamperes	Ventricular fibrillation Respiratory paralysis Possible death
10,000 Milliamperes	Cardiac arrest Severe burns Probable death

Example:

A worker is using a faulty 120 volt tool on a hot and humid day and is sweating heavily. The worker's body resistance is approximately 1,000 ohms.

Using Ohm's law:

- Current = 120 volts / 1,000 ohms.
- Current = 0.12 amps or 120 mA.

According to the above table, this amount of current will cause a painful shock, the workers's breathing may stop, there will be severe muscle contractions, and death is possible.

Arc Flash and Arc Blast

Arc-Flash-Arc- Flash burn can occur when an electrical equipment malfunction causes an extremely high temperature area around the

arc that can reach as high as 35,000 degrees Fahrenheit. Electrical burn can also occur any time an electrical current flows through bone or tissue.

Arc-Blast- When an arc occurs, a blast causes molten metal to be thrown through the air and onto the skin or into the eyes. The speed of the molten metal in an arc-blast is estimated at approximately 700 mph.

Donnie's Accident Story



An interactive or media element has been excluded from this version of the text. You can view it online here:
<http://pressbooks.oer.hawaii.edu/buildingmaint/?p=191>

Lockout-Tagout



Lock Out & Tag Out Code Book by Gwen Arkin is licensed under CC BY 4.0

Lockout-tagout is a safety procedure used in industry settings to ensure that dangerous machines and circuitry are properly shut off and not started up again prior to the completion of maintenance or service work. It requires that hazardous power sources be “isolated and rendered inoperative” before any repair procedure is started. “Lock and tag” works in conjunction with a lock securing the device or the power source with the hasp, and placing it in such a position that no hazardous power sources can be turned on. The procedure

requires that a tag be affixed to the locked device indicating that it should not be turned on.

When two or more subcontractors are working on different parts of a larger overall system, the locked-out device is first secured with a folding scissor-like clamp that has many padlock holes to hold it closed. Each subcontractor secures their own padlock to the clamp. The locked-out device cannot be activated until all workers have signed off on their portion of the project and removed their padlock from the clamp. A lock selected by color, shape or size (e.g. red padlock) is used to designate a standard safety device, locking and securing hazardous energy. No two keys or locks should ever be the same. A person's lock and tag must not be removed by anyone other than the individual who installed the lock and tag unless removal is accomplished under the direction of the employer.

- Identify the energy source(s)
- Isolate the energy source(s)
- Lock and Tag the energy source(s)
- No keys alike
- May only be removed by the installer
- Prove that the equipment isolation is effective

Electrical Systems and Testing Terminology

- **Continuity**- presence of a complete path for current to flow.
- **Resistor**- implements electrical resistance as a circuit element. In electrical circuits, resistors are used to reduce current flow, adjust signal levels, and to divide voltages.
 - Fixed value- have a single value of resistance.
 - Potentiometer- provides variable resistance by adjustment.

- **Open Circuit-** has intended interrupted path.
- **Closed Circuit-** has a complete path.
- **Short Circuit-** unintended path between two conductors.
- **Ground Fault-** unintended path to ground.
- **Arc Fault-** Normal when motor brushes spark and at receptacles when plugging in appliances and equipment that are in the “on” position.
 - Series- conductor is series with load is unintentionally broken.
 - Parallel- caused by short circuit or ground fault.

General Safety Rules for Electrical Maintenance Technicians

- Safety glasses, goggles, or face shields must be worn any time a hazard exists that can cause foreign objects to get in your eyes from the front or the sides.
- Head protection must be worn whenever there is a potential for objects to fall from above, for bumps to your head from objects fastened in place, or for accidental contact with electrical hazards.
- Hand protection must be worn any time your hands are exposed to a potential hazard.
- Do not wear clothing with exposed zippers, buttons, or other metal fasteners.
- Remove rings, wristwatches, and any other metal jewelry before beginning work.
- Make sure that tools used on energized electrical equipment are nonconductive and have the proper voltage rating.
- Install all electrical wiring according to the current NEC®

codes.

- Work with a buddy. Avoid working alone.
- Always turn power off and lock it out before working on any electrical circuits or equipment.
- Never cut off the grounding prong from a three-prong plug on any power extension cord or from a power cord to any piece of equipment.
- Do not defeat the purpose of any safety devices such as fuses or circuit breakers.
- Do not open and close switches under load unless absolutely necessary.
- **Assume all electrical equipment to be “live” and treat it as such.**

Non-Energized Testing

Never test an energized circuit when individual components of the circuit can normally be tested by other means. Most electrical components and pathways of electrical systems can be individually tested for continuity and resistance.

Insulated Tools

Insulated tools are designed for safety and are rated for live use up to 1000 VAC or 1500 VDC. They must be tested at 10 times that value (more than 10,000 V). Insulated tools should be used and stored differently from conventional, non-insulated tools. When being used, they should be kept isolated from other tools, including other insulated tools, to prevent them from getting scraped or nicked. They

should be inspected prior to each use and discarded or tested by a reliable authority if damage is suspected.

- Tool Rating: 1000 VAC or 1500 VDC
- Glove Rating: Tested: 20000VAC/50,000V DC., Max Use:17000VAC/25500V DC

5.2 Electrical Tools & Testing Equipment

While most all of the tools introduced in previous sections of this book can be used to perform many electrical maintenance tasks, other tools, some especially specific to the electrical trades, will be introduced in this section.

Electrical Tools



An interactive or media element has been excluded from this version of the text. You can view it online here:
<http://pressbooks.oer.hawaii.edu/buildingmaint/?p=193>

Electrical Meters and Testers

- **Direct Current (DC)**- DC is an electric current that is uni-directional, so the flow of charge is always in the same direction.
- **Alternating Current (AC)**- Alternating current changes its direction of flow at a specific frequency known as its' Hertz (Hz) rating. In the United States, AC current changes 60 times per

second or a rate of 60 Hz. In Europe the rating for AC current is 50 Hz

- **Continuity**- A complete pathway for current to flow.
- **Polarity**- Refers to the north and south poles of magnetic fields. Direction of flow of the current in DC circuits. Referred to as positive and negative.



An interactive or media element has been excluded from this version of the text. You can view it online here:
<http://pressbooks.oer.hawaii.edu/buildingmaint/?p=193>

Meter Safety

- Make sure the meter you are using has a rating equal to or exceeding the highest value of electrical quantity you are measuring.
- Always wear safety glasses when using test and measurement instruments.
- Wear rubber gloves when testing or measuring “live” electrical circuits or equipment.
- Keep your clothing, hands, and feet as dry as possible when taking measurements.
- Never work on energized circuits unless absolutely necessary.
- Don’t work alone, especially on “live” circuits.
- If you must take measurements on energized circuits, make sure you have been properly trained to work with “live” circuits.
- Recalibration is necessary from time to time to bring a meter

back to its intended level of accuracy.

Meter Care

- Handle all meters with care; they are fragile, sensitive instruments.
- Keep the meters clean and dry.
- Don't store analog meters next to strong magnets; magnets can cause the meters to become inaccurate.
- Don't expose meters to large temperature changes.
- Make sure you know the type of circuit you are testing (AC or DC)
- Never let the value being measured exceed the range of the meter.
- Multimeters and ohmmeters will need to have their batteries changed from time to time.
- Many meters have fuses to protect them from exposure to excessive voltage or current values.
- Re-calibrate measuring instruments once a year.

5.3 Electrical Terminology & Lighting

Terminology

Ground- is a safety conductor with a low impedance path to earth. It is often called the “**ground wire**” or safety ground. It is either bare or has green insulation.

Hot- is any conductor connected that has electric potential relative to electrical ground or neutral. In 110/220 volt systems this conductor is either black or red, and in some instances, blue. The hot conductor terminates on brass colored terminals.

Neutral- is also called the “**grounded conductor**” and is represented by the white insulated conductor. It will terminate on the silver terminal (longer slot on a receptacle face) of receptacles, and at the neutral bus bar in circuit breaker panels.

Leg-, as in “**hot leg**”, refers to one of multiple hot conductors in a circuit. Example: 240 volt circuits feature a neutral and two hot legs, 240 V to each other, and 120 V each to the neutral.

Line- is the “**in**” side of the device where the wires from the panel (or other equipment feeding the device) are connected.

Load- is the “**out**” side of the device where any items that are to be serviced by the device are connected.

Hard-wire- refers to directly wiring to an appliance’s terminal block or by wire nuts in a junction box instead of attaching it by using a receptacle and cord/plug assembly.

Ground Fault Circuit Interrupter (GFCI)- Disconnects a circuit when it detects that the electric current is not balanced between the energized conductor and the return neutral conductor. Could

be caused by current leakage through the body of a person who is grounded and accidentally touching the energized part of the circuit.

Lighting

LUMINAIRE

A luminaire is a complete lighting unit consisting of a lamp or lamps together with the fixture (parts designed to distribute the light, to position and protect the lamps and ballast (where applicable), and to connect the lamps to the power supply). The overall performance of a lighting system is a combination of the quantity and quality of light the lamps produce. Light output is measured in lumens. The amount of energy used by a lamp type is measured in watts. Efficacy is an indicator of performance which is rated in LPW (lumens per watt). The higher LPW, the more efficient the light source is.

LIGHTING FIXTURES

Lighting fixtures are designed to meet a variety of applications and aesthetic requirements. Each fixture comes with specific installation instructions provided by the manufacturer that should be read prior to installing the lighting fixture. Some can be both wall and ceiling mount, while other fixtures may be designed for only one method or the other. Each fixture also comes with labeling listing installation restrictions pertaining to location, mounting requirements, and wiring methods. Always connect fixtures to the electrical system with the proper polarity.

Common information found on a lighting fixture label:

- For wall mount only or ceiling mount only
- Maximum lamp wattage
- Lamp type
- Suitable for operation in an ambient temperature not exceeding _____°F (°C).
- Suitable for use in suspended ceilings, damp locations, and/or wet locations.
- Suitable for mounting on low-density cellulose fiberboard.
- For supply connections, use wire rated at least _____ °F (°C).
- Thermally protected.
- Type *Non-IC or **Type IC (common to recessed ceiling fixtures that are often called “can” fixtures)

*Type NON-IC- Installed so the insulation is no closer than 3” (75 mm) to any part of the fixture.

**Type IC- Designed to be in direct contact with thermal insulation.

LAMP TYPES

Light is the visible portion of the electromagnetic spectrum. Lamp manufacturers are concerned with three factors: color temperature, color rendering, and lamp efficacy.

Color temperature of a light source is a measurement of its color appearance measured in degrees Kelvin (°K). Light at higher-temperature wavelengths (blue and white) is referred to as “cool”, whereas light from lower-temperature wavelengths is referred to as “warm”. These descriptions have nothing to do with temperature, but with the way the colors appear. Warm light sources are commonly used for residential applications because they make colors appear more natural and vibrant.

Incandescent- Relies on the resistance of a tungsten filament to

create light. Least efficient as it produces more heat than light. Standard household incandescent bulbs are being phased out of production.

Florescent-Requires a magnetic or electronic ballast to provide voltage surge required to start the lamp and current control that allows the lamp to operate efficiently. Consists of a tube filled with inert gas like argon or krypton, and small amount of mercury. Electrons emitted from cathodes strike particles of mercury vapor, producing ultraviolet radiation causing a phosphor coating on the inside of the glass tube to glow and produce light energy. More efficient than incandescent lighting.

Compact Florescent- These bulbs were developed to save up to 75% in energy cost and last 10 times longer than incandescent models. CFLs have heavy metal environmental disposal concerns to include lead, zinc, copper and mercury.

Light-Emitting Diode (LED)- LEDs offer energy savings of 80% to 90% over incandescent lamps with a reported operating life of up to 100,000 hours. They are offered in most all bulb sizes and base configurations.

5.4 Conduit, Boxes, & Wiring

Conduit

Raceways are defined as enclosed channels of metal or nonmetallic material designed expressly for holding wires or cables. Branch-circuit installation using a raceway (conduit) wiring method is seldom used in residential wiring. However, some areas of the country require that all wiring in a house be installed in a raceway wiring method. Raceways should be installed as a complete system and be securely fastened in place and supported by an approved retainer.

Use individual conductors when installing a circuit in a raceway wiring method. It is common wiring practice to install a green insulated equipment grounding conductor in every raceway. Electric codes have specific requirements for wiring in different types of conduit that include allowable fill rates that vary depending upon wire size and insulation type.

The following conduits are used primarily in light to heavy commercial application and are listed here for your reference:

Rigid metal conduit (RMC)– RMC is generally made of steel with a protective galvanized coating. It is a threadable raceway designed for the physical protection and routing of conductors and cables and for use as an equipment grounding conductor when installed with appropriate fittings. It can be used in all atmospheric conditions and forms of occupancy. Requires pipe and thread cutting specialty tools.

Intermediate metal conduit (IMC)– IMC is a thinner-walled version of rigid metal conduit and can be used in all locations in a house where rigid metal conduit is permitted to be used. It can be used as an equipment grounding conductor when installed with

associated couplings and appropriate fittings. Requires pipe and thread cutting specialty tools.

Raceways used in residential wiring include:



An interactive or media element has been excluded from this version of the text. You can view it online here:
<http://pressbooks.oer.hawaii.edu/buildingmaint/?p=202>

EMT Conduit Bending

Bending conduit is a skill that improves with practice. The most common electrical conduit installed in houses is EMT and, for this reason, the discussion that follows on conduit bending will focus on EMT. The bending techniques described may also apply to the other types of circular metal raceways.

EMT is bent in the field using either a hand bender, a hydraulic bender, or an electric bender. Bend sizes 1/2" through 1-1/4" are usually formed with a hand bender. A hydraulic or electric power bender is generally used for larger sizes. Since most EMT installed in houses will be 1/2", 3/4", or 1" trade sizes, we will focus on bending with a hand bender.

When making a bend using a hand bender:

- Wear safety glasses and observe all applicable safety rules.
- Bend on a flat surface that is not slippery.
- Mark the locations on the conduit where you wish to make the bends clearly and accurately.
- Apply heavy foot pressure on the foot pedal to keep the conduit tightly in the bender.
- When making multiple bends on the same pipe length, keep all bends in the same plane.

IDEAL Hand Conduit Benders



An interactive or media element has been excluded from this version of the text. You can view it online here:
<http://pressbooks.oer.hawaii.edu/buildingmaint/?p=202>

IDEAL Benders How To Bend a Stub



An interactive or media element has been excluded from this version of the text. You can view it online here:
<http://pressbooks.oer.hawaii.edu/buildingmaint/?p=202>

IDEAL Hand Conduit Bender How to Make a Back to Back Bend



An interactive or media element has been excluded from this version of the text. You can view it online here:
<http://pressbooks.oer.hawaii.edu/buildingmaint/?p=202>

Conduit Bending Basics 3 Bend Saddle



An interactive or media element has been excluded from this version of the text. You can view it online here:
<http://pressbooks.oer.hawaii.edu/buildingmaint/?p=202>

Boxes

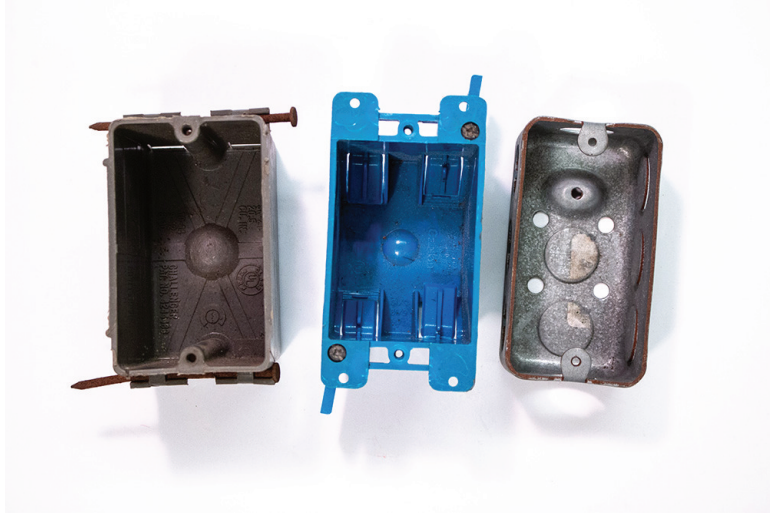

Electrical Boxes by Gwen Arkin is licensed under CC BY 4.0

Electrical boxes have many mounting options that range from configurations designed to be nailed or screwed to framing members or blocking, to models for remodeling (called an “old work” box) that attach to the sheetrock that encloses a wall pocket.

Device Boxes- are used to install receptacles or switches at specific locations on an electrical circuit. Standard box openings are approximately 3” x 2” with a depth that ranges from 1-1/2” to 3-1/2”.

Outlet Boxes- are used when installing lighting fixtures in a ceiling or on a wall and when connecting small or large appliances. They are larger than a device box and provide more room for different wiring

situations. Outlet boxes are offered in round, octagon, or square shapes.

Junction Boxes (J-Box)- These are used when several conductors are spliced together at a point on the wiring system. The NEC® requires junction boxes to be accessible after installation without the finish of a building having to be altered. Junction boxes must always be covered.

Heavy Load Boxes- Specifically designed and tested to support heavier loads. Used for heavier loads such as ceiling suspended paddle fans. Heavy load boxes can be manufactured with metal or nonmetal material.

Metal Boxes

A metal device box often includes the capability of having the sides of the box removed and the boxes ganged together to make a box that can accommodate multiple devices. The most common metal device box size 3" x 2" x 3-1/2". Another type of metallic device box recognized by the NEC® is the "handy" or "utility" box. This type of box is primarily used for surface mounting and can accommodate one device such as a receptacle or switch.

Nonmetallic Device Boxes

Nonmetallic boxes are usually made of PVC, phenolic, or polycarbonate. The specific advantages of using these boxes include that they are lightweight, strong, very easy to install, and inexpensive. Most all nonmetallic boxes are wired using a nonmetallic sheathed cable wiring method. Nonmetallic boxes are

offered in single-gang, two-gang, three-gang device box, and fixture mounting styles.

PVC Conduit Boxes

Although PVC boxes are designed and used for glue-up assembly, some models have female threaded fittings to accommodate a variety of threaded connectors.

Wires (Conductors)

Conductors in residential wiring are usually installed in a cable assembly. They are made of copper, aluminum, and copper-clad aluminum. Copper is preferred because of its great ability to conduct electricity, its strength, and its low instance of problems over the long term.

Conductors are sized according to the American Wire Gauge (AWG). Conductors used in residential wiring typically range in size from 14 AWG to 2/0 copper. The larger the number, the smaller the conductor. The smaller the number, the larger the conductor. Conductor sizes larger than 4/0 are listed in kcmil (1000 circular mils).

Ampacity is the current in amperes that a conductor can carry continuously under the conditions of use without exceeding its temperature rating. A residential electrician or maintenance technician must be able to choose the correct conductor size based on the ampacity needed for each circuit they are working with. The ampacity of a conductor depends not only on the diameter size of

the conductor, but also on the length of the conductor, and what insulation type the conductor has.

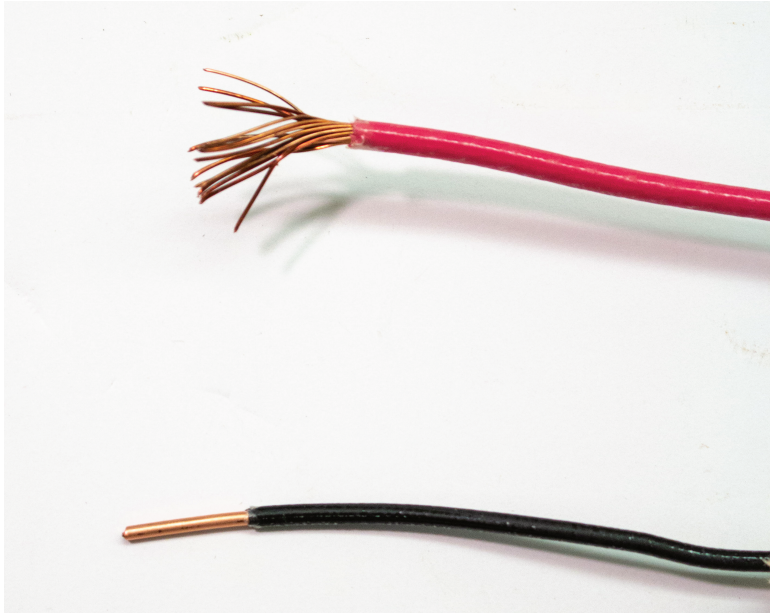

Stranded Wire vs Solid Wire by Gwen Arkin is licensed under CC BY 4.0

THHN and THWN are codes for the two most common types of insulated wire used inside conduit. These types of conductors are often used in conjunction with flexible conduit in unfinished areas, such as basements and garages, and for short exposed runs inside the home, such as wiring connections for garbage disposers and hot water heaters. They are also used in solid material conduit branch circuits. The letters indicate specific properties of the wire insulation:

T: thermoplastic

H: heat-resistant; HH means highly heat-resistant

W: rated for wet locations

N: nylon-coated, for added protection

Solid Core VS. Stranded Wire- While solid wire consists of a single metal core, while a stranded wire is composed of numerous thinner wires twisted together into a cohesive bunch. Both types of wire are appropriate for commercial and residential installation, however each has particular advantages and disadvantages that lead to the choice of one over another for each particular application.

USE	SOLID WIRE	STRANDED WIRE
Where flexibility is important	NO	YES
Protection against corrosion	YES	NO
Outdoor use	YES	NO
Repetitive motion	NO	YES
Price advantage	YES	NO

Wire Color and Use

Color choice for the insulation of the conductors installed in a raceway depends on the type of circuit it serves.

- For a 120-volt branch circuit, use a white insulated wire and a black insulated wire.
- For a straight 240-volt circuit (like an electric water heater), use two black conductors or a black and a red conductor.
- If the circuit is a 120/240-volt circuit (like an electric clothes dryer), run a white insulated wire, a black insulated wire, and a red insulated wire.

The NEC® requires that each conductor be color coded to indicate the function that it performs in a circuit.

Black– Used as an ungrounded or “hot” conductor and carries the current to the load in 120-volt circuits.

Red– Also used as an ungrounded or “hot” conductor and carries current to the load in 120/240-volt circuits like an electric clothes dryer circuit.

White– Used as the grounded circuit conductor

- Returns current from the load back to the source
- Called “neutral” conductor, but only true “neutral” when used with black and red wire in multi-wire circuit

Bare– Used as equipment grounding conductor that bonds all non-current carrying metal parts of a circuit together; never carries current.

Green (can be green with yellow stripes)– Used as an insulated equipment grounding conductor; never carries current.

Conductor Installation

Conductors are usually pulled into the conduit, but in shorter runs between electrical boxes conductors they may be pushed through the raceway. Conductors are taken off spools in a way that results in the conductors coming off the spools easily and not becoming tangled with each other. One of the easiest ways to do this is to use a wire cart that allows several spools of wire to be put on at one time.

If the length of conduit between boxes is fairly long, use a fish tape. If the conduit already contains wires, be sure the circuits that supply them are de-energized. Pull the fish tape out of its reel. Insert it into a raceway and push it through until it comes out at a box location. The fish tape will have a hook on the end of it. Attach the conductors to the fish tape end. While one person pulls the conductors slowly off the spools, another person will pull the fish tape with the attached conductors back through the raceway.



An interactive or media element has been excluded from this version of the text. You can view it online here:
<http://pressbooks.oer.hawaii.edu/buildingmaint/?p=202>

If the length of a conduit run is longer than the length of your longest fish tape, another technique can be used. One technique uses a vacuum/compression device to blow or suck a “mouse” with a string tied to it though the length of conduit. Once the mouse has been blown or sucked through the conduit, the attached string is removed from the mouse and tied to a stronger pulling rope, which is then pulled though the conduit. The pulling rope is then attached to the wires and they are pulled into the conduit.

Terminations



An interactive or media element has been excluded from this version of the text. You can view it online here:
<http://pressbooks.oer.hawaii.edu/buildingmaint/?p=202>

Cable Types

Cable wiring methods are easier to install than raceway wiring methods, and this is the main reason why most houses are wired using as little conduit as possible. Cable wire contains all of the conductors needed for the circuit in a single insulated unit.

When purchasing cable wiring system the cable is referred to by two numbers: the first number specifies the gauge; the second the number of current carrying conductors in the wire. Additionally, there's usually another wire that is used for grounding (green or bare). "12-2" means 12 gauge, two insulated current carrying wires, and a bare ground. 12-2 wire usually has a black, white and bare ground wire. Black, red, and a ground with no white wire is used for 220V circuits without neutral. 12-3 wire usually has a black, red, white and bare ground wire and is used for 220V with neutral or in three-way switch applications as the traveler between the switches where an additional wire is required.

Nonmetallic-Sheathed Cable (Type NM)- Also known as "Romex". Least expensive and most used residential wiring method to purchase and install.

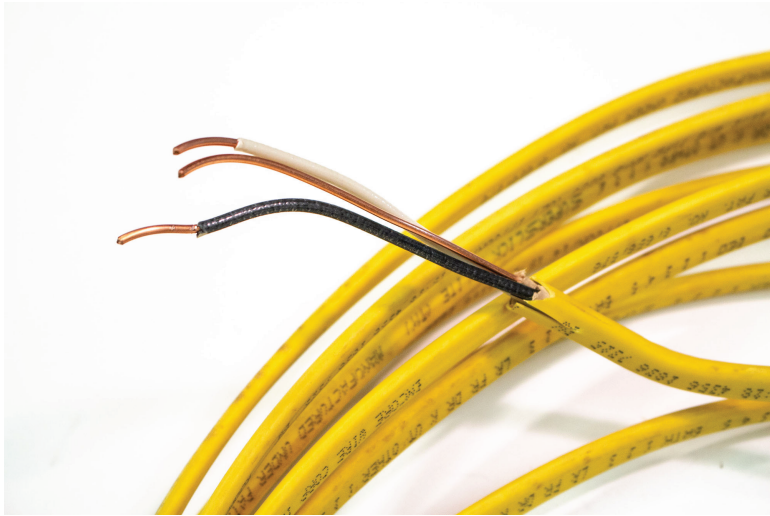

Romex® Cable by Gwen Arkin is licensed under CC BY 4.0

Types of Type NM cable:

- **Type NM-B (white outer jacket)**- Most common type; use in dry locations only. Has a flame-retardant, moisture-resistant, nonmetallic outer jacket.
- **Type NMC-B (yellow outer jacket)**- Not used often in residential work ; use in dry or damp locations. Has a flame retardant, fungus and corrosion resistant, nonmetallic outer jacket.
- **Type NMS-B (orange outer jacket)**- Used in new homes with home automation systems. Contains power conductors, telephone wires, coaxial cable for video, and other data conductors all in the same cable. Has moisture-resistant, flame-retardant, nonmetallic outer jacket.

Underground Feeder Cable (Type UF)- Used for underground

installation of branch circuits and feeder circuits. Also used in interior installations, but must be installed following the installation requirements for Nonmetallic-Sheathed Cable.



Underground Feeder Cable (Type UF) by Clifford Rutherford is licensed under CC BY 4.0

Armored-Clad (Type AC) and Metal-Clad (Type MC) Cable- Certain locations in the United States may not allow

Nonmetallic Sheathed Cable in residential construction. Both have a metal outer sheathing and provide very high levels of physical protection for the conductors in the cable. Electricians sometimes find it hard to tell Type AC (also known as “BX” cable) and Type MC apart. Type AC cable has brown paper covering each conductor and Type MC cable has a clear plastic wrap around all of the conductors.



Metal-Clad (MC) Cable by Gwen Arkin is licensed under CC BY 4.0

5.5 Fuses & Breakers

In residential wiring, overcurrent protection devices consist of fuses or circuit breakers. The NEC® states that overcurrent protection for conductors and equipment is provided to open the circuit if the current reaches a value that will cause an excessive or dangerous temperature in conductors or conductor insulation. Both circuit breakers and fuses are used for this purpose. However, circuit breakers are used in most building electrical systems.

Panelboards and Loadcenters

The following items are used to contain and organize overcurrent devices in residential, commercial, and industrial wiring applications:

Panelboard- A single panel that includes automatic overcurrent devices used for the protection of light, heat, and power circuits.



E.T-N

Bitte bei Leistung über 1000 W
 ein Schutzkleinleistungsschalter (SLS) verwenden.
 Bei Verwendung des SLS
 muss die Leitung mit einem
 Querschnitt von mindestens
 1,5 mm² sein.
 Bei Verwendung des SLS
 muss die Leitung mit einem
 Querschnitt von mindestens
 1,5 mm² sein.

Typ	1000 W	1000 W
Spannung	230 V	230 V
Strom	4,3 A	4,3 A
Leistung	1000 W	1000 W
Lebensdauer	10 Jahre	10 Jahre
Hersteller	ET-N	ET-N

WARNING

Always read the label
 instructions for correct
 installation. Do not use
 the device for any other
 purpose than intended.
 The manufacturer is not
 responsible for damage
 caused by incorrect
 installation or use.
 The manufacturer is not
 responsible for damage
 caused by incorrect
 installation or use.

E.T-N

Bitte bei Leistung über 1000 W
 ein Schutzkleinleistungsschalter (SLS) verwenden.
 Bei Verwendung des SLS
 muss die Leitung mit einem
 Querschnitt von mindestens
 1,5 mm² sein.
 Bei Verwendung des SLS
 muss die Leitung mit einem
 Querschnitt von mindestens
 1,5 mm² sein.

1	2
3	4
5	6
7	8
9	10
11	12
13	14
15	16
17	18
19	20
21	22
23	24
25	26
27	28
29	30
31	32
33	34
35	36
37	38
39	40
41	42

DANGER

Do not touch the
 live parts.
 The device is
 not to be used
 for any other
 purpose than
 intended.

WARNING

Always read the label
 instructions for correct
 installation. Do not use
 the device for any other
 purpose than intended.
 The manufacturer is not
 responsible for damage
 caused by incorrect
 installation or use.

Handwritten notes on a piece of paper taped to the door.

NOTICE

Always read the label
 instructions for correct
 installation. Do not use
 the device for any other
 purpose than intended.
 The manufacturer is not
 responsible for damage
 caused by incorrect
 installation or use.

DANGER

Panelboard by Gwen Arkin is licensed under CC BY 4.0

Loadcenter-A type of panelboard that contains the main disconnecting means for the residential service entrance as well as the fuses or circuit breakers used to protect circuits and equipment like water heaters, ranges, dryers, and lighting.

Safety Switches- A safety switch is used as a disconnecting means for larger electrical equipment. It is typically mounted on the surface of or near the equipment and is operated with an external handle. Safety switches can simply be an On/Off device or can have overload protection devices incorporated in their design. Safety switches can be found in both cartridge fuse or breaker configurations.

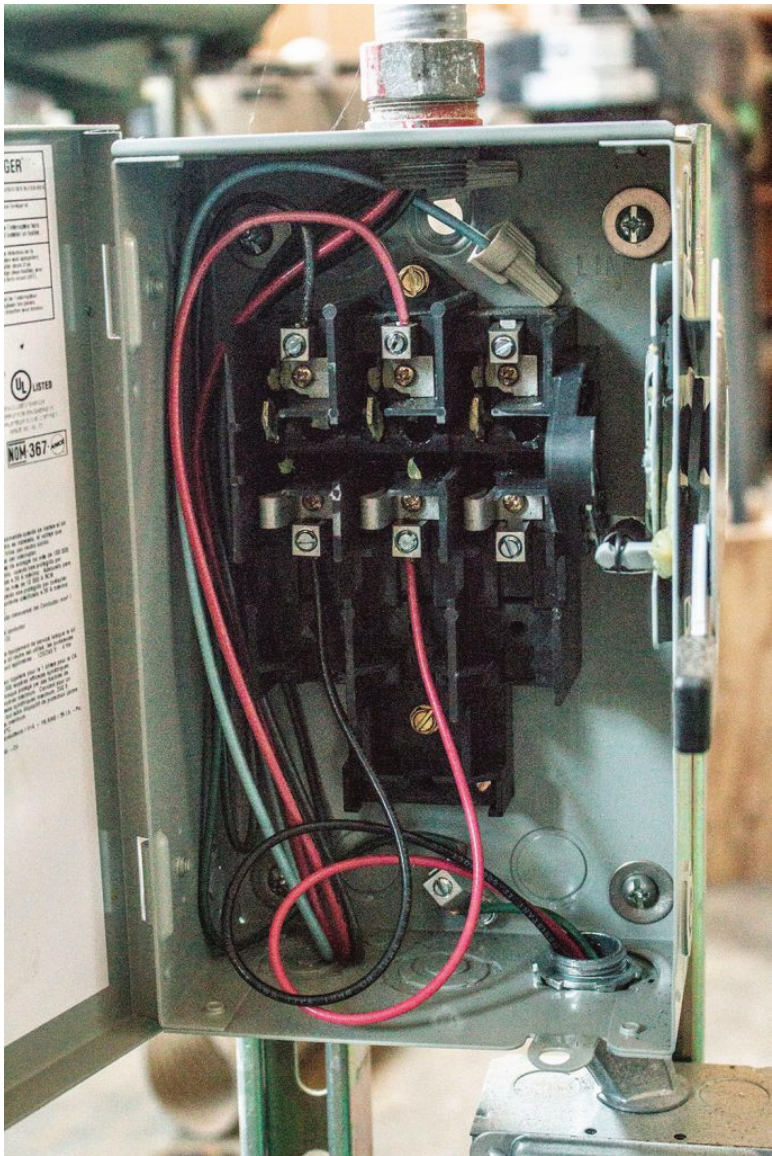

Fuses

A fuse is an overcurrent protection device that opens a circuit when a fusible link is melted away by the extreme heat caused by an over current. Causes can include a short circuit or excessive load. Electricians and maintenance technicians may encounter two styles of fuses protecting circuits:

Plug fuses- These fuses “screw” into a socket device, either an Edison base model or a Type S model. These devices are seldom used as circuit breakers can be reset and are considered more reliable and tamper resistant. Some codes may restrict the use of plug fuses in building electrical systems.



Plug Fuse by Gwen Arkin is licensed under CC BY 4.0

Cartridge fuses- Cartridge fuses are available as a ferrule model or a blade-type model. Fuses must be plainly marked, either by printing on the fuse barrel or by a label attached to the barrel showing the amperage and voltage ratings. Often used in equipment safety switches.



Cartridge Fuse by Mako Shimada is licensed under CC BY 4.0

Circuit Breakers

Circuit breakers- are available as a single-pole device for 120-volt applications and as a two-pole device for 240-volt applications. They also come as a twin or dual device that fits in the space of a regular single-pole breaker. Circuit breakers are designed so that any fault must be cleared before the circuit breaker can be reset. Even if the handle is held in the “ON” position, the circuit breaker will remain tripped as long as there is a trip-rated fault on the circuit. In some cases, time is required for the breaker to cool before it can be reset.

- Most branch circuits are 120-volt circuits. These are wired with 14 AWG or 12 AWG copper conductors and require 15 or 20 amp single-pole circuit breakers. A single-pole circuit breaker takes up one space on a panelboard.
- Many branch circuits serve appliances like electric water heaters, air conditioners, and electric heating units. These loads require 240 volts to operate properly. since it is a 240-volt

circuit, it needs a two-pole circuit breaker. A two-pole circuit breaker takes up two spaces on the panelboard.

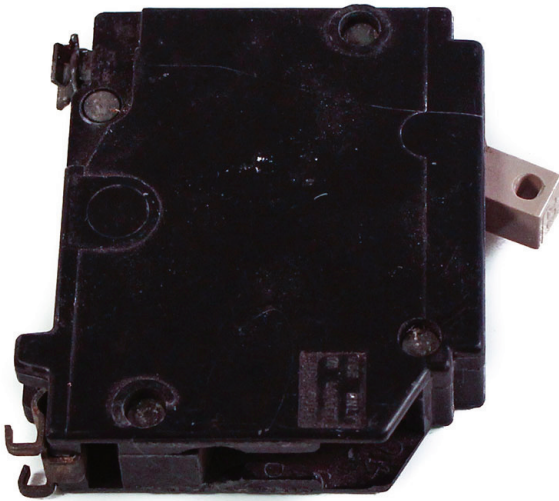

20 Amp Circuit Breaker by Mako Shimada is licensed under CC BY 4.0

It is important to note the manufacturer and style of a breaker when replacing it. Different manufacturers produce proprietary designs that can only be used in their own panels and are not compatible with others.

240-Volt Branch Circuit Requirements

- 15-amp circuit breaker when wired with 14 AWG wire

- 20-amp circuit breaker when wired with 12 AWG wire
- 30-amp circuit breaker when wired with 10 AWG wire

Appliance Circuits- There may be a need for 120/240 volts to be supplied to appliances such as electric clothes dryers and electric ranges. This installation requires a two-pole circuit breaker, just like the 240-volt-only application. The difference is that a three-wire cable with a grounding conductor is used.

Ground Fault Circuit Interrupter (GFCI)- Although GFCIs look very similar to regular circuit breaker, there are two very evident differences: A GFCI breaker has a white pigtail attached to it that is wired to the neutral bar in the panel; and a GFCI breaker has a “Push to Test” button located on the front. GFCIs are also available as receptacle devices that can be placed in-line with standard breakers.



GFCI Circuit Breaker by Bernard Sula is licensed under CC BY 4.0

Arc Fault Circuit Interrupter (AFCI)- AFCI devices are designed

to trip when they sense rapid fluctuations in the current flow that are typical of arcing conditions. AFCI protection is provided with AFCI circuit breakers and new codes require that all residences be constructed with them. AFCI circuit breakers look very similar to GFCI circuit breakers. The “Push-to-Test” button is typically a different color than that of a GFCI breaker.



AFCI Circuit Breaker by Clifford Rutherford is licensed under CC BY 4.0

Common Branch Circuits

General Branch Circuits

- **14 AWG** copper conductor and protected with a **15-ampere** fuse or circuit breaker.
- **12 AWG** copper conductor protected with a **20-ampere** fuse or circuit breaker.

Small Appliance Branch-12 AWG copper conductors. Larger size wire may be used to compensate for voltage drop when the distance back to the electrical panel is very long.

- **Washer**- 120 Volt 20 Amp
- **Garbage Disposal**- 120 Volt 15 Amp
- **Dishwasher**- 120 Volt 15 Amp

Range Branch-Uses an 8/3 copper cable with ground protected by a 40-ampere circuit breaker, or a 6/3 copper cable with ground protected by a 50-ampere circuit breaker.

Clothes Dryer Branch- Usually a 30-amp circuit wired with 10/3 cable. Usually connected to the electrical system in a house through a cord-and-plug type connection.

Water Heater Branch- Electric water heaters used in homes normally operate on 240 volts. They normally require a 10 AWG conductor with a 30-ampere overcurrent protection device. Some smaller single element electric water heaters may require 120 volts and will be wired with a dedicated branch circuit with 12 AWG conductors and a 20-ampere overcurrent protection device.

Circuit Breaker Replacement

Always turn off electrical power at the main service breaker when working in an energized main breaker panel.

- The LOAD side of the panel will be disconnected, but the LINE side will still be energized.
- If you are working in an energized subpanel, find the circuit breaker in the service panel, turn it off, and lock it in the OFF position.

Test the panel you are working on with a voltage tester to verify

that the electrical power is off.

- NEVER assume the panel is de-energized.

Circuit breakers are installed by attaching them to the main bus bar assembly in the panel. The bus bar assembly is connected to the incoming service entrance conductors and distributes the electrical power to each of the circuit breakers located in the panel. In the case of a subpanels, bus bars are connected to the incoming feeder conductors.

Circuit breakers are attached to the bus bar by contacts in the breakers being snapped onto the bus bar at specific locations, commonly called stabs.

- A single-pole circuit breaker has one stab contact.
- A two-pole circuit breaker has two stab contacts.

GFI Breaker Installation



An interactive or media element has been excluded from this version of the text. You can view it online here:

<http://pressbooks.oer.hawaii.edu/buildingmaint/?p=211>

5.6 Receptacle & Switch Wiring

Receptacles and switches are known as devices. A device is defined as a unit of an electrical system intended to carry, but not use, electric energy. Components that distribute or control energy, but do not consume electricity include:

- Switches
- Receptacles
- Attachment plugs
- Lamp holders or sockets

Always de-energize the electrical circuit first before servicing or installing any of the following devices.

Receptacles

Receptacles are contact devices installed at the outlet for the connection of an attachment plug. While many people (including electricians) refer to a receptacle as an “outlet”, “socket”, or “plug,” they are the wrong terms to use.

A single receptacle is a single contact device.

A duplex receptacle has two contact devices.

A multiple receptacle has more than two contact devices.

Common House Wiring Receptacles

125 Volt Receptacles

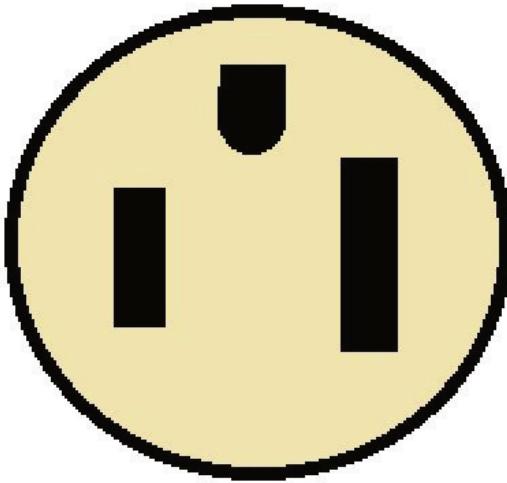

**15 AMPERE, 125 VOLT, NEMA
5-15R RECEPTACLE, CAN BE USED
ON 15 AMPERE MAXIMUM BRANCH
CIRCUITS. THE TALLER SLOT IS THE
GROUNDED CONDUCTOR SLOT**

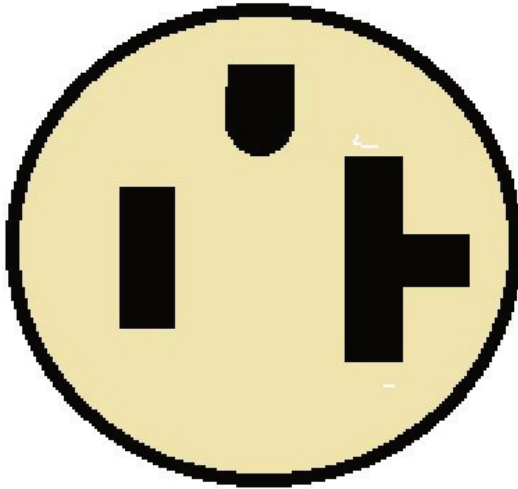

**20 AMPERE, 125 VOLT, NEMA
5-20R RECEPTACLE, CAN BE USED
ON BOTH 15 AND 20 AMPERE
BRANCH CIRCUITS. THE "T" SLOT
IS THE GROUNDED CONDUCTOR**

15 Amp, 125 V and 20 Amp, 125 V by Clifford Rutherford are licensed under CC BY 4.0

250 Volt Receptacles

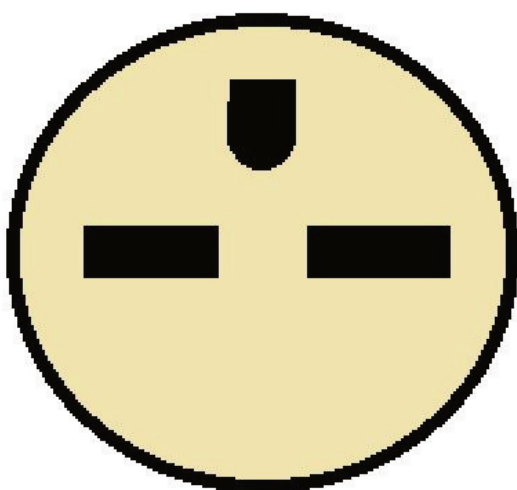

**15 AMPER, 250 VOLT, NEMA
6-15R RECEPTACLE, CAN BE USED
ON 15 AMPERE MAXIMUM BRANCH
CIRCUITS. STANDARD 125 VOLT
PLUGS WILL NOT FIT. OFTEN USED
FOR 240 VOLT WINDOW AC UNITS.**

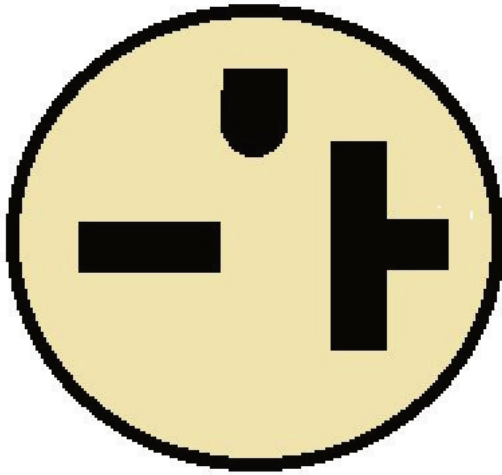

**20 AMPERE, 250 VOLT, NEMA
6-20R RECEPTACLE, CAN BE USED ON
BOTH 15 AND 20 AMPERE BRANCH
CIRCUITS. 125 VOLT PLUGS WILL
NOT FIT. CAN BE USED FOR 240 VOLT
WINDOW AIR CONDITIONERS**

15 Amp, 250 V and 20 Amp, 250 V by Clifford Rutherford are licensed under CC BY 4.0

Receptacle Installation

When connecting circuit conductors to a receptacle (or switch):

Form terminal loops in the wire, put the loop under a terminal screw, looping the wire around the terminal screw in the direction the screw tightens (clockwise in almost all cases), and tighten the screw the proper amount. A terminal screw that is not tightened properly or a wire not looped properly around a screw will typically be the cause of future problems. Push-in terminations are available but are not as good a termination as a terminal loop termination.

The listing instructions for devices like receptacles and switches normally allow only one wire to be terminated to each terminal screw. However, many electrical boxes containing receptacles or switches could have many circuit conductors requiring connections to the device terminal screws. The best way to make the necessary connections so that only one conductor gets connected to a terminal screw is to use a pigtail.

Once the particular receptacle you are installing is connected to the electrical system, secure it to the device box. Make sure the conductors inside the box are pushed to the back of the device box, leaving enough room to install the receptacle.

Carefully push the receptacle into the device box, checking that the ears on the top and bottom of the receptacle yoke will rest against the sheetrock when the receptacle is installed. Once you have determined that the receptacle ears will rest against the drywall or finish surface properly, attach the receptacle to the device box using the properly sized machine screws. Make sure the receptacle is flush with the wall and straight, then attach the cover.

Duplex Receptacles (3 Wires): The most common type of receptacle used in residential wiring is a duplex receptacle rated for 15 amperes at 125 volts. It consists of two single receptacles on the same mounting strap. As many of these devices are installed close to ground level, Tamper-Resistant (T-R) receptacles are required in some locations to protect children.



20 Amp Duplex by Bernard Sula is licensed under CC BY 4.0

Ungrounded black conductor- Connected to the brass colored terminal

Grounded white conductor- Connected to the silver screw terminal

Bare or green grounding conductor- Connected to the green grounding screw

How Tamper-Resistant Receptacles Work



An interactive or media element has been excluded from this version of the text. You can

view it online here:

<http://pressbooks.oer.hawaii.edu/buildingmaint/?p=227>

Split-Wired Duplex Receptacle- A split-wired duplex receptacle usually has a switch controlling half of the receptacle and the other half is hot all the time. They are often used to provide an accessible switching device near a doorway that controls a plug-in table lamp across the room (ex: bedside table- split-wire receptacle allows the light to be turned on and off by the doorway, but the alarm clock plugged into the same duplex receptacle remains on at all times). Before installing, remove the tab connecting the terminal screws on the hot side of the receptacle. Do not remove the tab connecting the silver terminal screws.

Ground Fault Circuit Interrupter GFCI- Connect GFCI receptacles to the electrical system in much the same manner as regular duplex receptacles. However, on the back of the GFCI receptacles, one of the brass screw terminals and one of the silver screw terminals are marked for the “Line,” or incoming power conductors. The other set of screw terminals are marked as “Load” terminals, or the outgoing power conductors that protect other receptacles downstream of the GFCI.



GFCI Receptacle by Clifford Rutherford is licensed under CC BY 4.0

Specialty Receptacle Types

Two appliances typically require a special 125/250 volt receptacle installation. These receptacles are larger and have different configurations than the single or duplex receptacles.

125/250 Volt Electric Clothes Dryer

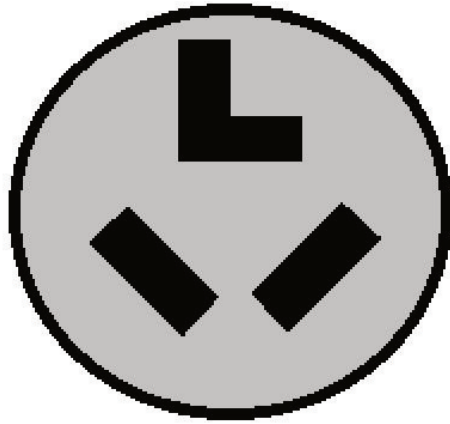

**30 AMPERE, 3 POLE, 3 WIRE,
125/250 VOLT, NEMA 10-30R
PERMITTED PRIOR TO 1996 NEC®**

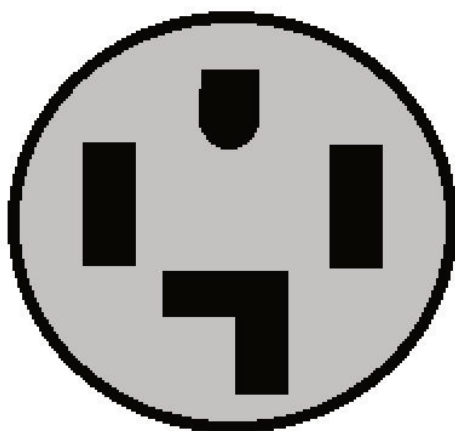

**30 AMPERE, 4 POLE, 4 WIRE,
125/250 VOLT, NEMA 14-30R
REQUIRED FOR NEW INSTALL
SINCE 1996 NEC®**

Dryer 30 Amp, 3 Pole and Dryer 30 Amp, 4 Pole by Clifford Rutherford
are licensed under CC BY 4.0

125/250 Volt Electric Range

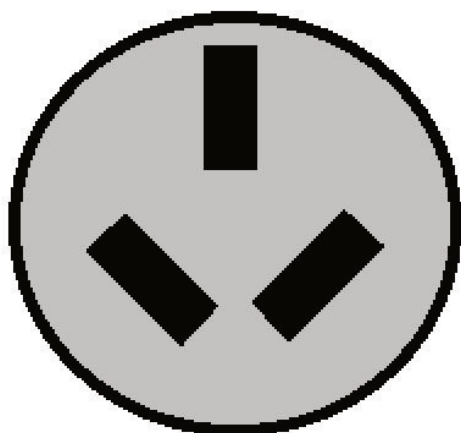

**50 AMPERE, 3 POLE, 3 WIRE,
125/250 VOLT, NEMA 10-30R
PERMITTED PRIOR TO 1996 NEC ®**

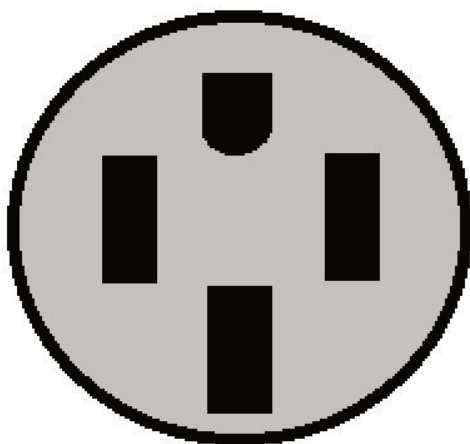

**50 AMPERE, 4 POLE, 4 WIRE,
125/250 VOLT, NEMA 14-50R
REQUIRED FOR NEW INSTALL
SINCE 1996 NEC®**

Range 50 Amp, 3 Pole and Range 50 Amp, 4 Pole by Clifford Rutherford are licensed under CC BY 4.0

Switches

Switches are used to control the various lighting accessories, and sometimes receptacles or equipment, installed in residential wiring. The procedures for installing a switch are very similar to receptacle installation procedures. The main difference is the number of

switches installed in multi-gang boxes: In residential installations, two- and three-gang switch boxes are common. Take care to ensure there is enough room in the device box for all conductors and switches.

There are two styles of switches commonly used residential and commercial construction: toggle and rocker (also known as decor). While rocker switches are also considered decorative and may be more desirable in some cases, they often have a wider profile than toggle switches and may require more space in the switch box. Because there are so many multi-gang switch boxes, make sure all the switches are level so the faceplate will be level when it is installed.

Switch rating must be matched to the voltage and current you encounter with the circuit on which you are using the switch. Many residential lighting circuits are wired with 14 AWG conductors protected with a 15-amp circuit breaker and will require switches with a 15 amp, 120 volt rating. This switch rating is the most common found in residential wiring.

Single-pole, three-way, and four-way switches are to be wired so that all switching is done in the ungrounded circuit conductor. There is no need to connect a white insulated grounded conductor to any switch in a residential switching circuit.

Single Pole Switch- The single-pole switch used in 120- volt circuits to control a lighting outlet or outlets from only one location is the most common. On a single-pole switch, two wires will be connected to the two terminal screws on the switch. Both wires will be considered “hot” ungrounded conductors. One is the incoming power wire and the other wire runs to the light fixture or receptacle.

- Connect two conductors (usually black or re-identified as such*) to the switch
- Ground the switch.
- Set up the switch so it will read “OFF” when the toggle is in the down position.

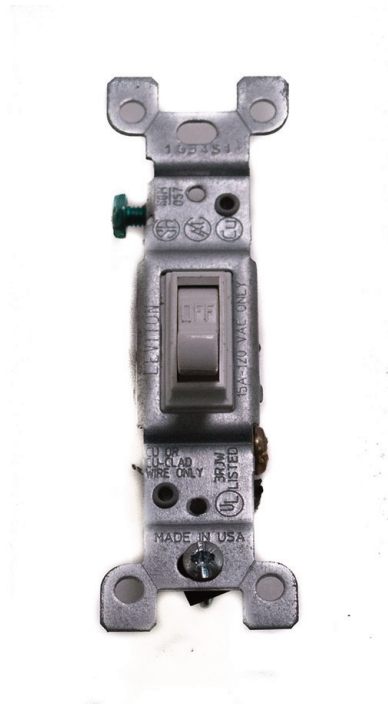

Single Pole Switch by Clifford Rutherford are licensed under CC BY 4.0

***Switch Loop**

It is very common for residential electricians to run the power source to the lighting outlet first and then to run a two-wire cable to the single-pole switching location. When employing a switch loop, use the white wire as an ungrounded conductor and identify it as such. It is required that the white conductor be identified at both ends as a hot conductor. Use black electrical tape, although another color tape (like red or blue) may also be

used, or a permanent marker to mark the conductor. The mark must completely encircle the conductor.

Three-Way Switch- Connects three conductors to the switch to control a light fixture or receptacle from two locations, such as at the top and bottom of a stairway. Three and four-way switches do not have On/Off markings on them. Beginning electricians and maintenance technicians often find the connections for three-way switches confusing. Learning some basic rules can make the process much easier.

Rules For Three-Way Switches

- Three-way switches must always be installed in pairs.
- A three-wire cable must always be installed between the two three-way switches.
- When wiring with conduit, three separate wires must be pulled into the conduit between the two three-way switches.
- The black colored “common” terminal on a three-way switch should always have a black insulated wire attached to it.
 - One three-way switch will have a black “hot” feed conductor attached to it.
 - The other three-way switch will have the black insulated conductor that will be going to the lighting load attached to it.
- Connect the two traveler conductors to the two brass colored “traveler” terminals and the conductor that provides power.
- When using nonmetallic sheathed cable:
 - When the power source feed is brought to the first three-way switch, the traveler wires that interconnect the traveler terminals of both switches will be black and red.
 - When the power source feed is brought to the lighting

outlet first, the traveler wires will be red and white.

- Re-identify the white traveler conductors with black tape at each switch location.
- Ground the switch.

Four-Way Switch- Four-way switches have four conductors connected to them. Four-way switches are used in 120-volt circuits to control a lighting load from three or more locations, such as in a room with three doorways that calls for switches controlling the room lighting to be located at each doorway. They are used in conjunction with two three-way switches. Two conductors will come from one three-wire cable and two conductors will come from a second three-wire cable.

- Connect the conductors from one cable to the two screw terminals that are the same color (traveler terminal screws).
- Connect the remaining two conductors to the two screw terminals that are a different color (traveler terminal screws).

Double-Pole Switch- These switches are used on 240-volt circuits to control a load from one location (ex: electric water heater). The double-pole switch has four terminals on it and, at first glance, looks like a four-way switch. Unlike a four-way (or three-way) switch, the toggle on the double-pole switch does have the words “ON” and “OFF” written on it. This means that like a single-pole switch, there is a correct mounting position for the switch so when it is “ON”, the toggle will indicate it. The double-pole switch also has markings that usually indicate the “load” and the “line” sides of the switch. Usually the “line” set of terminals is colored black and the “load” set of terminals is colored a brass or bronze.

Dimmer Switches- are used to brighten or dim a lighting fixture's lamps. Found in both a singlepole and a three-way configurations,

both are available with either a rotating knob style or sliding switch that varies the resistance in the circuit. Dimmer switches differ from regular switches in that they do not have terminal screws, but instead have colored insulated pigtail wires coming off the switch installed by the manufacturer. To install a dimmer switch, connect the dimmer switch pigtails to the appropriate circuit conductor with a wirenut. Single-pole or three-way dimmer switches are connected in a switching circuits exactly as regular single pole and three-way switches.

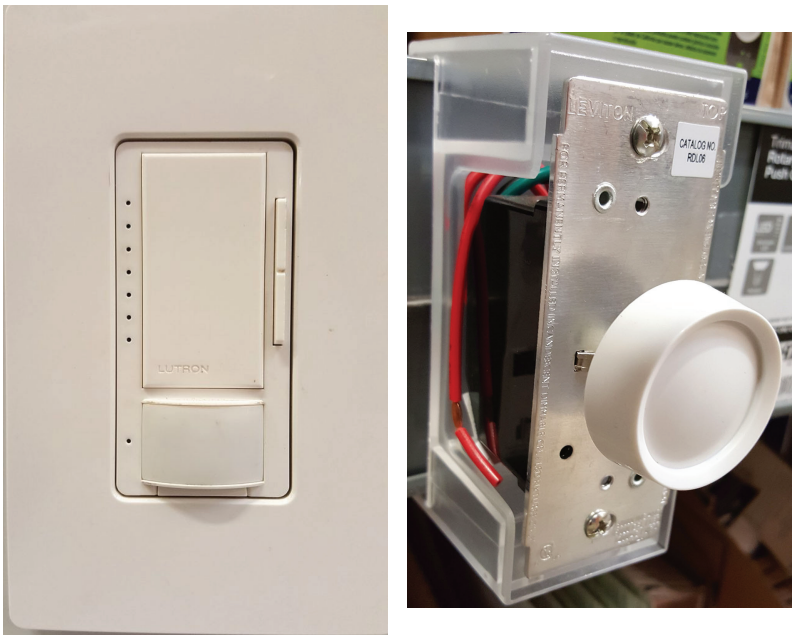

Slide Dimmer & Rotary Dimmer by Clifford and Rosemary Rutherford are licensed under CC BY 4.0

Combination Devices

Combination devices have a combination of two devices, both of which are mounted on the same strap. There could be two single-pole switches, a single-pole switch and a three-way switch, a single-pole switch and a receptacle, or a single-pole switch with an indicator light.

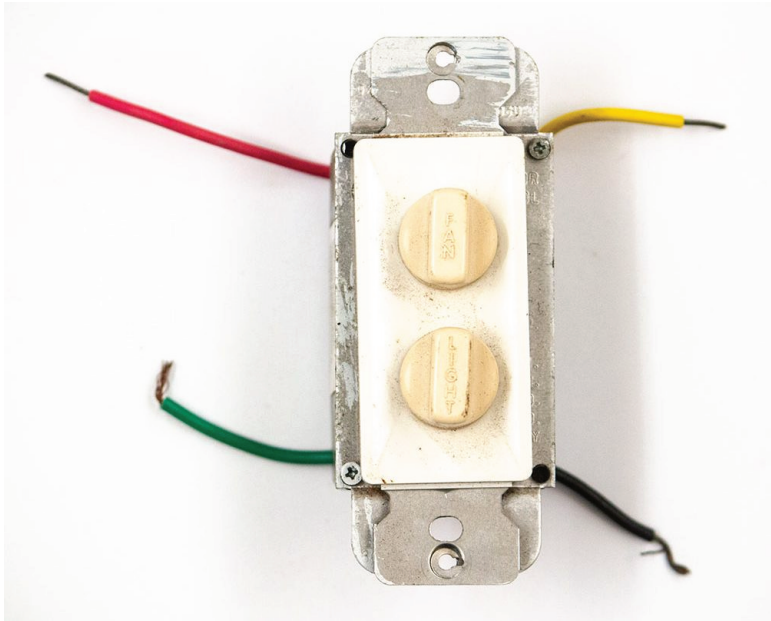

Combination Switch by Gwen Arkin are licensed under CC BY 4.0

5.7 Outdoor Wiring Considerations

Wiring for Outdoors

Outdoor electrical wiring in residential situations includes installing the wiring and equipment for lighting and power equipment located outside of the house. Wiring may be installed overhead or underground. Most underground receptacle and lighting circuits installed in residential wiring are done using Type UF (Underground Feeder) Cable. Type UF Cable must be physically marked as underground feeder cable and is available from 14 AWG through 4/0 AWG copper and from 12 AWG through 4/0 aluminum. Type UF can be used outdoors in direct exposure to the sun only if listed as being sunlight-resistant with a sunlight-resistant marking on the cable sheathing. It can be buried directly in the ground or installed according to the same rules as for Nonmetallic Sheathed Cable when used as an interior wiring method.

Any wiring installed in an underground conduit must have a 'W' in its insulation designation, such as "THWN" or "XHHW". The 'W' means that the conductor insulation is suitable for installation in a wet location. Rigid PVC Conduit (PVC) is used for underground conduit installation with these wires. Minimum burial depths for both Type UF Cable and for any of the conduit wiring methods can be found in the NEC® code book.

Outdoor Receptacles

Receptacle outlets located outdoors must be installed in weatherproof enclosures. The electrical boxes are usually made of metal and are often called a “Bell Box”. They typically have threaded openings or hubs that allow attachment to the box with conduit or a cable connector. These boxes come from the factory with a few threaded plugs that are used to seal any unused threaded openings to make the box truly weatherproof. Outdoor boxes can be mounted on the surface of an outside wall or on some other structural support such as a wooden post rising from the ground. They are often installed with underground wiring and supported by conduits coming up out of the ground.



Bell Box by Clifford & Rosemary Rutherford is licensed under CC BY 4.0

When a receptacle is installed outdoors, the enclosure and cover combination must maintain its weatherproof characteristics whether a cord plug is inserted into the receptacle or not. This is accomplished by installing a self-closing cover that is deep enough to also cover the attached plug cap on a cord. PVC boxes can also be used for outdoor applications when secured with an approved

weatherproof or weather resistant cover. The receptacle must be a listed and marked weather-resistant (WR) type.

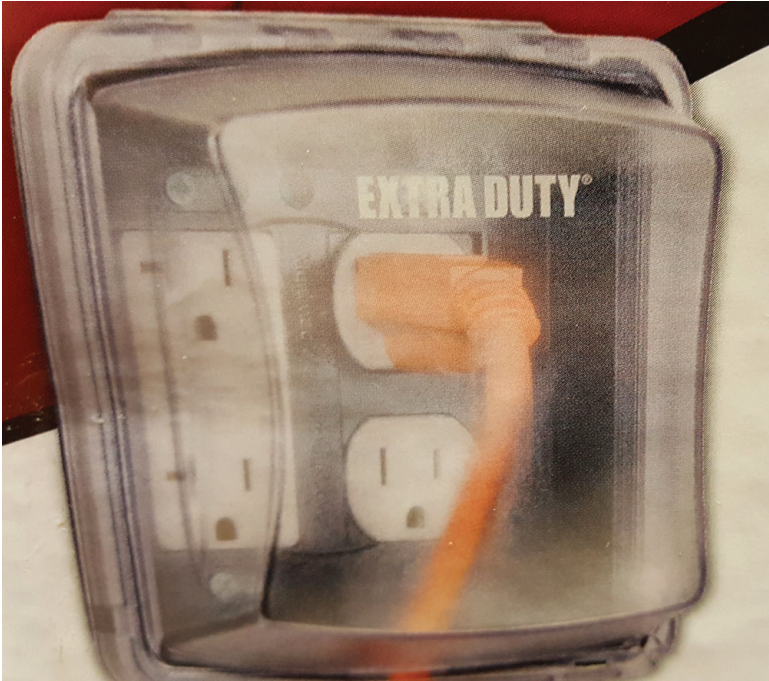

Outdoor Receptacle Cover by Clifford & Rosemary Rutherford is licensed under CC BY 4.0

Outdoor Lighting

Outdoor lighting can be mounted on the side of building structures, on poles, or even on trees. According to codes, any luminaire (lighting fixture) installed outdoors and exposed to the weather must be listed as suitable for the location and have a label with a marking that states “Suitable for Wet Locations”. If a luminaire is to be installed under a canopy or under an open porch, it is considered a “damp” location

and the fixture only needs a label that states “Suitable for Damp Locations.”

Although codes allow outdoor lighting fixtures to be mounted on trees, they also mandate that overhead conductor spans cannot be supported by trees or other living or dead vegetation. This means that when installing wiring to a tree-mounted lighting fixture, an underground wiring method must be used between each tree.

PART 6: MAINTENANCE MANAGEMENT SYSTEMS

6.1 Maintenance Categories

Maintenance procedures can be classified in three basic categories:

Corrective Maintenance is known as **reactive maintenance**. In other words, waiting for something to break down before worrying about repairing or replacing it. While this process may require less expense in manpower, it can contribute to longer than normal downtime while waiting on replacement parts or equipment to arrive, or a need to have an extensive inventory of those replacement parts or equipment on hand.

Preventive Maintenance is also referred to as **scheduled maintenance**. This form of maintenance is based on a time based understanding of when breakdown occurs, when specific preventive measures are not taken. Preventive maintenance focuses on replacing or repairing worn or expended system parts before failure occurs, extending the life of mechanical systems. Common scheduled maintenance tasks include changing filters and lubricants, cleaning and flushing of contaminants, correcting tolerance discrepancies, and other items that keep machinery and buildings operating at their peak efficiency.

Predictive Maintenance relies on regular analysis of data collected from in-service system equipment and components to determine when maintenance will be required or a time when failure will occur. Predictive maintenance procedures often include **computerized maintenance management systems (CMMS)** to gather information from data loggers or sensors which are placed on equipment to track temperature, humidity, speed, pressure, voltage, amperage, flow rates, occupancy, and a multitude of other factors related to the performance of a piece of equipment or building system. When a data logger records a measurement that is outside of a set parameter, the computer sends an alarm that can be

programmed to perform many functions to include but not limited to: create a work order, send out digital information to maintenance staff via text or email, and shut down equipment to prevent catastrophic failure.

Although initial setup of CCMS systems can be quite costly, over time this form of maintenance can result in significant savings from not having to keep a large inventory of replacement parts on hand, efficient scheduling of people and ordering of parts, and less unplanned failure of equipment. CCMS systems are commonly found in commercial buildings such as hospitals, office and institutional buildings, and resorts.

6.2 Work Order Process

Commercial Maintenance Process

Service Request

A service request can be occupant or operator generated due to a system failure or for preventive/predictive maintenance scheduling.

- **Work Order-** Informs technician of the failure or maintenance procedure for corrective action.
- **Inspection-** Technician assessment for restoring failed component or service of equipment to operable or optimal condition.
- **Repair-** Process of restoring failed component or equipment to operable or original condition.

Repairs often requires the acquisition of parts or materials that may not be immediately available. This may result in **“down time”** for a necessary piece of equipment or facility component until the item can be obtained. In order to restore operation in a timely manner, it is important to obtain the parts that are right for the job by knowing where to look and knowing how to properly describe the item(s) when ordering.

Service Call Procedures

A service call is required if a building or equipment operator finds something wrong with a building system or appliance's operation.

There are a few steps to follow for a successful service call:

- Display a professional, courteous, and intelligent attitude when dealing with customers.
- Don't track dirt or mud into the service location.
- Make sure your tools do not cause damage to walls, floors, furniture, or other items.
- Be prepared to show some identification.
- Find the problem.
- Fix the problem.
- Explain what you found and how you fixed it to the customer.
- Fill in the appropriate paperwork in a legible manner.
- Make one last inspection of the work area.
- Clean up any mess you made.

6.3 Parts and Material Resources

Maintenance technicians have numerous resources at their disposal to obtain repair instructions, replacement parts, and other resources that can contribute to safe, successful, and timely repairs.

Manufacture and Vendor Parts and Repair Resources

- **Owner's Manual-** General customer orientation of equipment or component. Often contains safety precautions, operating instructions, basic troubleshooting and warranty information.
- **Technical/Service Manual-** Professional field technician repair reference. Contains complete troubleshooting instructions, schematics, and technical information related to the manufacturer.
- **Vendor-** Store or source where part might be obtained. Many vendors carry items from multiple manufactures, however, many manufactures may act as sole distributors for their own items.
- **Catalog/Internet-** Manufacturer or vendor itemization of available parts, description, and price.

Part Types

- **Original Equipment Manufacturer (OEM)**- manufactures products or components that are purchased by a company and retailed under that purchasing company's brand name.
- **Replacement (aftermarket)**- Item made to perform the same function as original part, not manufactured by original equipment manufacturer.
- **Universal**- part made by a manufacturer that may replace similar parts on multiple manufacturers' items or models of equipment.

Procurement

In many commercial settings, the technician is required to provide a purchase order (PO) to a vendor in order to obtain the necessary items to perform the service.

Requisition- The service technician must submit a request (requisition) to their employer or business office for the purchase of the required item(s). The requisition most often requires an accurate description of the item(s), price, part number, quantity, vendor, and vendor contact information.

Purchase Order- Once the technician has submitted the requisition for materials, the business office will generate a purchase order. This is an agreement between the purchaser and vendor for placing the purchase on a payment account. The business office will, in most all cases, issue a purchase limit or specified amount to be attached to the order based on previously quoted prices from the vendor.

Ordering Parts & Materials

When creating requisitions or ordering parts, equipment, and building materials from vendors, **be specific**. If any of the data on a replacement part does not match the original manufacturer's requirements, the part/s may not provide adequate service for the application and could potentially damage other components of equipment and machinery. Manufacturers' information is often available on the **manufacturer's tag** or **nameplate** found on equipment, motors, pumps, propellers, blower motors, and other components. This information can be key to identifying and finding parts that are specific to an individual piece of equipment. Technical manuals provide more in-depth information, can be helpful in identifying specific parts and repair procedures, but do not always offer a way to obtain parts for repairs. Remember that manufacturers and parts vendors do not stock repair items forever. After production runs of various items end, the parts resource no longer carries specific parts and the item being repaired becomes obsolete or beyond economic repair (a similar item can be purchased at a cost that is cheaper than repairing the broken one).

Some of the most important things that can help a technician find the parts they need for repairs can be found on equipment nameplates or tags, or even on individual equipment parts and components include:

- **Brand/Manufacturer-** Maker or registered trademark holder
- **Serial Number-** Unique to the individual piece of equipment, often associated with ownership
- **Model-** Model numbers can signify a difference in power, size, accessories, or a wide variety of other options found in the terminology in this chapter
- **Part number-** Specific to the part, can often be cross-

referenced to replacement and universal parts numbers

- **Capacity or Rating**

- **Horsepower**- Associated with gas and electric motors and appliances
- **Torque/Ft. Lbs.**- Amount of output force
- **Speed**- RPM/ Variable/Fixed; Tool, motors, saw blades
- **Voltage**- Alternating or direct current requirement
- **Ohms/ Impedance**- resistance
- **Amps**- Maximum and minimum or operational current
- **Wattage**- Power capacity of electric appliances
- **Microfarad/Picofarad**- Capacitors
- **British Thermal Units (BTUs)/Tons**- Heating, air conditioning and refrigeration equipment
- **Weight**- Lift or support limits
- **Phase**- Electrical equipment; single or three phase
- **Cycle/Stroke**- Gas motors

- **Descriptive Terms**

- **Gauge**- Thickness of sheet metal, wiring conductors
- **Swing**- Door and window direction of travel as they open
- **Pane**- thickness of glass
- **Temper**- hardened such as steel or glass
- **Finish**- metal finishes, paints, stains,
- **Sheen**- gloss, semi-gloss, matte, etc.
- **Rotation**- clockwise/counterclockwise; fan and saw blades, threaded fasteners
- **Coarse/Fine**- Screws, sandpaper, and other textured items

Quantities

Specific amounts, quantities, weights and sizes are always necessary for ordering parts and materials:

- **Length/Width/ Height/Thickness-** anything with proportional size
- **Diameter/ Circumference/ Radius/Inside or Outside Diameter (I.D., O.D.)-** tubing, plumbing, fan blades, motor shaft sizes, filters, etc.
- **Schedule-** PVC & ABS pipe wall thickness
- **Area-** square ft. square mile sheet goods, land (acre)
- **Board Foot-**lumber, 144 cubic inches or 12" x 12" x 1"
- **Gross-** Twelve dozen (144)
- **Bag-** contains a marked weight or item quantity
- **Bundle-** contains a marked weight or item quantity
- **Ply-** amount of layers an item has. Tires, plywood, paper products
- **Roll-** Paper products, asphalt roofing, plastic sheet goods, cloth and textile materials
- **Unit-** lumber, liquids, cased materials. Can imply a single item or a specific amount packaged for bulk purchase.
- **Yard/Cu. Ft. /Sq. Yd.-** concrete, fill, fertilizer
- **Per inch/ foot/yd./etc.-** lumber, wire, chain

Weights & Measures

Liquid Measures- pint, quart, gallon, liter, etc.

Dry Measures- gram, ounce, pound, ton, etc.

Standardized Measurement

Metric: European decimal equivalency; centimeters, millimeters, meters

SAE (Society of Automotive Engineers): American standard, fractional

Threads per inch (TPI): Bolts, nuts, and other fasteners

National Pipe Thread (NPT): tapered thread for plumbing applications