

Essential Skills Companion Kit for Culinary Arts Trades Training



About the Authors

Marlin Ratch,
Francesca de Bastiani,
Shelby Desjarlais,
Chef Andrew George,
Chef Nathan Hyam,
Chef Chris Monkman,
Jason Forseth,

Project Coordinator
Curriculum Developer
Project Assistant
Content Expert
Content Expert
Content Expert
Graphic Designer

Book Description

The Essential Skills Companion Kit to Culinary Arts Trades Training was developed to complement technical Culinary Arts Trades Training. The various activity sets are designed to reinforce academic information that students are required to know during their training. The Content Experts provided the Curriculum Development Team with themes and the curriculum was created to practice Essential Skills such as Reading Text, Document Use, Thinking Skills, Oral Communication and Working with Others.

Copyright

Unless otherwise noted, this book is released under a Creative Commons Attribution 4.0 Unported License also known as a CC-BY license. This means you are free to copy, redistribute, modify or adapt this book. Under this license, anyone who redistributes or modifies this textbook, in whole or in part, can do so for free providing they properly attribute the book as follows:

Essential Skills Companion Kit for Culinary Arts Trades Training by the Office of Literacy and Essential Skills used under a CC-BY 4.0 international license.

For questions regarding this licensing, please contact opentext@bccampus.ca. To learn more about BCcampus Open Textbook project, visit <http://open.bccampus.ca>

About the Book

The Essential Skills Companion Kit to Culinary Arts Trades Training includes a series of activity sets organized by theme. The activity sets are to be used by learners who are studying Culinary Arts. Each chapter contains a series of individual activity sets with lesson plans. The activity sets were designed to address key technical information that some learners may struggle with, and therefore provide additional practice to make the learning stick. Some of the activities require preparation on behalf of the instructor to make sets of the material for group and individual practice. These sets can be laminated for multiple use.

The material was created by certified Essential Skills Practitioners in collaboration with certified Red Seal Chef Instructors. The Chef Instructors shared their technical training material with the curriculum developers and highlighted the areas that they found that many learners who require stronger Essential Skills, could benefit from. The companion kit has been designed to support the ITA Professional Cook 1 learning resources, with additional contributions from the authors.

The raw material was provided to a local Graphic Designer, Jason Forseth from Seabird Island First Nation, owner operator of Nadia Design. This designer was able to make the material come alive so to speak and gives the product it's interactive and highly visual feature.

The material is useful for an under Level 3 learner and the Essential Skills being practiced are mainly: Reading Text, Document Use, Thinking Skills, Working with Others, Oral Communication and Continuous Learning.



Preface

The creation of the Essential Skills Companion Kit for Culinary Arts Trades Training has been a labour of love since 2012 when it was originally jump started by Metis Nation BC and funded through the Office of Literacy and Essential Skills. Unfortunately the project came to an abrupt halt and was 90% completed by 2013. The project sat for some time due to lack of funding but was never forgotten as it was felt that learners and instructors could truly benefit from the material. Many organizations supported the completion of the product but due to lack of funding, the project remained incomplete.

We would like to acknowledge Sto:lo Nation Human Resource Development (SNHRD), go2HR, Chef Andrew George, Gitxaala Nation, Vancouver Aboriginal Friendship Centre, ACCESS and BCcampus for providing funding and in-kind donations to complete this Essential Skills Companion Kit for Culinary Arts Trades Training.

We sincerely hope that Culinary Arts Instructors will enjoy integrating the material into their technical training for the benefit of their students.

Happy cooking!



Table of Contents

ABOUT THE AUTHORS	2
BOOK DESCRIPTION	2
COPYRIGHT	2
ABOUT THE BOOK	3
PREFACE	4
TABLE OF CONTENTS	5
PROFESSIONALISM	21
LESSON PLAN - CHEFS AND RESTAURANTS - WORD/DEFINITION MATCH	22
CHEFS AND RESTAURANTS	23
CHEFS AND RESTAURANTS - WORDMATCH	24
LESSON PLAN - CULINARY FRENCH VOCABULARY - WORD/DEFINITION MATCH	27
CULINARY FRENCH VOCABULARY	28
CULINARY FRENCH VOCABULARY - WORDMATCH	29
LESSON PLAN - THE CLASSIC & MODERN KITCHEN VOCABULARY - WORD/DEFINITION MATCH	34
THE CLASSIC & MODERN KITCHEN VOCABULARY	35
THE CLASSIC KITCHEN VOCABULARY - WORDMATCH	36
LESSON PLAN - ON TASTE - FILL IN THE BLANKS	40
ON TASTE	41
ON TASTE - ANSWERS	42
LESSON PLAN - PRIDE IN THE UNIFORM - FILL IN THE BLANKS	43
PRIDE IN THE UNIFORM	44
PRIDE IN THE UNIFORM - ANSWERS	45
FOOD SAFETY & SANITATION	46
LESSON PLAN - TERMS AND DEFINITIONS - WORD/DEFINITION MATCH	47
TERMS AND DEFINITIONS	48
TERMS AND DEFINITIONS - WORDMATCH	50
LESSON PLAN - ACRONYMS - WORD/DEFINITION MATCH	56
ACRONYMS	57

ACRONYMS - WORDMATCH	58
ACRONYMS - PRACTICE SHEET	59
ACRONYMS - QUIZ	60
ACRONYMS - ANSWERS	61
LESSON PLAN - DISH AND EQUIPMENT CLEANLINESS	62
DISH AND EQUIPMENT CLEANLINESS - STUDY SHEET	63
DISH AND EQUIPMENT CLEANLINESS - EXERCISE	64
LESSON PLAN - TEMPERATURE DANGER ZONE - POCKET GUIDE AND POSTER	65
TEMPERATURE DANGER ZONE - 4X CUT-OUTS	66
TEMPERATURE DANGER ZONE - 8.5 X 11	67
TEMPERATURE DANGER ZONE - 11 X 17 POSTER	68
LESSON PLAN - PROPER HAND WASHING PROCEDURES - POCKET GUIDE AND POSTER	69
PROPER HAND WASHING PROCEDURES - 2X CUT - OUT	70
PROPER HAND WASHING PROCEDURES - 8.5 X 11	71
PROPER HAND WASHING PROCEDURES - 11 X 17 POSTER	72
LESSON PLAN - SAFE BEHAVIOR ON THE JOB - FILL IN THE BLANKS	73
SAFE BEHAVIOR ON THE JOB - 8.5 X 11 POSTER	74
SAFE BEHAVIOR ON THE JOB - FILL IN THE BLANKS	75
SAFE BEHAVIOR ON THE JOB - FILL IN THE BLANKS - ANSWERS	76
SAFE BEHAVIOUR ON THE JOB - 11 X 17 POSTER	77
LESSON PLAN - SAFETY ALERT - FILL IN THE BLANKS	78
SAFETY ALERT - EXERCISE	79
SAFETY ALERT - EXERCISE ANSWERS	80
TOOLS & EQUIPMENT	81
LESSON PLAN - STANDARDS FOR TOOLS AND EQUIPMENT	82
STANDARDS FOR TOOLS AND EQUIPMENT - STUDY SHEET 2X CUT - OUT	83
STANDARDS FOR TOOLS AND EQUIPMENT - WORDMATCH	84
LESSON PLAN - SELECTING TOOLS & EQUIPMENT - FILL IN THE BLANKS	85
SELECTING TOOLS AND EQUIPMENT	86
SELECTING TOOLS AND EQUIPMENT - ANSWERS	87
LESSON PLAN - HAND TOOLS - PICTURE/WORD MATCH	88

HAND TOOLS - EXERCISE	89
HAND TOOLS - ANSWERS	90
LESSON PLAN - METALS USED FOR KNIVES – THE TANG - PARTS OF A KNIFE – KNIFE NAMES	91
METALS USED FOR KNIVES	92
PARTS OF A KNIFE	93
PARTS OF A KNIFE - EXERCISE	94
KNIFE NAMES - STUDY SHEET	95
KNIFE NAMES - EXERCISE	96
KNIFE NAMES - EXERCISE ANSWERS	97
LESSON PLAN - WORK SECTIONS & THEIR STATIONS	98
WORK SECTIONS AND THEIR STATIONS	99
WORK SECTIONS AND THEIR STATIONS - WORDMATCH	100
LESSON PLAN - HEAT DISTRIBUTION - FILL IN THE BLANKS	101
COOKWARE - HEAT DISTRIBUTION - EXERCISE	102
COOKWARE - HEAT DISTRIBUTION - ANSWERS	103
LESSON PLAN - COPPER COOKWARE - FILL IN THE BLANKS	104
COOKWARE - COPPER EXERCISE	105
COOKWARE - COPPER - ANSWERS	106
LESSON PLAN - ALUMINUM COOKWARE - FILL IN THE BLANKS	107
COOKWARE - ALUMINUM EXERCISE	108
COOKWARE - ALUMINUM - ANSWERS	109
LESSON PLAN - STAINLESS STEEL COOKWARE - FILL IN THE BLANKS	110
COOKWARE - STAINLESS STEEL EXERCISE	111
COOKWARE - STAINLESS STEEL - ANSWERS	112
LESSON PLAN - CAST IRON COOKWARE - FILL IN THE BLANKS	113
COOKWARE - CAST IRON EXERCISE	114
COOKWARE - CAST IRON - ANSWERS	115
LESSON PLAN - GLASS COOKWARE - FILL IN THE BLANKS	116
COOKWARE - GLASS EXERCISE	117
COOKWARE - GLASS - ANSWERS	118
LESSON PLAN - CERAMIC COOKWARE - FILL IN THE BLANKS	119

COOKWARE - CERAMIC EXERCISE	120
COOKWARE - CERAMIC - ANSWERS	121
LESSON PLAN - PLASTIC WARE - FILL IN THE BLANKS	122
COOKWARE - PLASTIC WARE EXERCISE	123
COOKWARE - PLASTIC WARE - ANSWERS	124
LESSON PLAN - ENAMEL COOKWARE - FILL IN THE BLANKS	125
COOKWARE - ENAMEL EXERCISE	126
COOKWARE - ENAMEL - ANSWERS	127
EGGS & BREAKFAST COOKERY	128
LESSON PLAN - COMPOSITION OF EGGS	129
COMPOSITION OF EGGS - EXERCISE	130
COMPOSITION OF EGGS - ANSWERS	131
LESSON PLAN - GRADING EGGS	132
GRADING EGGS - EXERCISE	133
GRADING EGGS - ANSWERS	134
LESSON PLAN - STORING EGGS	135
STORING EGGS - EXERCISE	136
STORING EGGS - ANSWERS	137
LESSON PLAN - MORE ABOUT EGGS!	138
MORE ABOUT EGGS! - EXERCISE	139
MORE ABOUT EGGS! - ANSWERS	140
LESSON PLAN - METHODS OF COOKING EGGS - A	141
METHODS OF COOKING EGGS - A	142
METHODS OF COOKING EGGS - A - ANSWERS	143
LESSON PLAN - METHODS OF COOKING EGGS - B	144
METHODS OF COOKING EGGS - B	145
METHODS OF COOKING EGGS - B - ANSWERS	146
LESSON PLAN - BACON AND EGGS	147
SHOOTS & LADDERS EXERCISE 11 X 17 BOARD GAME	148
LESSON PLAN - EGG SIZES	149
EGG SIZES 4X CUT - OUT	150

LESSON PLAN - PARTS OF AN EGG	151
PARTS OF AN EGG - EXERCISE	152
PARTS OF AN EGG - EXERCISE - ANSWERS	153
LESSON PLAN - EGG GRADES	154
EGG GRADES	155
LESSON PLAN - EGG VARIETIES	157
EGG VARIETIES	158
EGG VARIETIES 4X CUT - OUT	159
SOUPS, STOCKS AND SAUCES	160
LESSON PLAN - SOUPS, STOCKS & SAUCES - STOCK VOCABULARY	161
STOCKS - STUDY SHEET	162
STOCKS - WORDMATCH EXERCISE	163
LESSON PLAN - THE VELOUTE FAMILY	166
THE VELOUTE FAMILY	167
THE VELOUTE FAMILY (CON'T)	168
LESSON PLAN - THE BROWN STOCK FAMILY	169
THE ESPAGNOLE (BROWN SAUCE) FAMILY	170
LESSON PLAN - THE HOLLANDAISE FAMILY	171
THE HOLLANDAISE FAMILY	172
LESSON PLAN - THE TOMATO SAUCE FAMILY	173
THE TOMATO SAUCE FAMILY	174
LESSON PLAN - THE BECHAMEL FAMILY	175
THE BÉCHAMEL FAMILY	176
VEGETABLES & STARCHES	177
LESSON PLAN - VEGETABLES - FILL IN THE BLANKS	178
VEGETABLES - EXERCISE	179
VEGETABLES - ANSWERS	180
LESSON PLAN - VEGETABLE IDENTIFICATION - STUDY SHEET & RECALL EXERCISES	181
VEGETABLE IDENTIFICATION - STUDY SHEET	182
VEGETABLE IDENTIFICATION - CATEGORY IDENTIFICATION EXERCISE	183
VEGETABLE IDENTIFICATION - EXAMPLE IDENTIFICATION EXERCISE	184

LESSON PLAN - VEGETABLE CATEGORIES - BOOKLET, RECALL BOOKLET & PICTURE MATCH	185
VEGETABLE CATEGORIES - BULBS	186
VEGETABLE CATEGORIES - FLOWER & BUDS	187
VEGETABLE CATEGORIES - FLOWER & BUDS (CON'T)	188
VEGETABLE CATEGORIES - FRUIT VEGETABLES	189
VEGETABLE CATEGORIES - FRUIT VEGETABLES (CON'T)	190
VEGETABLE CATEGORIES - FUNGUS (PLURAL = FUNGI)	191
VEGETABLE CATEGORIES - LEAFY GREENS	192
VEGETABLE CATEGORIES - LEGUMES/PODS AND SEEDS	193
VEGETABLE CATEGORIES - ROOTS AND TUBERS	194
VEGETABLE CATEGORIES - SHOOTS AND STALKS	195
VEGETABLE CATEGORIES - EXAMPLE IDENTIFICATION EXERCISE	196
VEGETABLE CATEGORIES - EXAMPLE IDENTIFICATION EXERCISE	197
VEGETABLE CATEGORIES - EXAMPLE IDENTIFICATION EXERCISE	198
VEGETABLE CATEGORIES - EXAMPLE IDENTIFICATION EXERCISE	199
VEGETABLE CATEGORIES - EXAMPLE IDENTIFICATION EXERCISE	200
VEGETABLE CATEGORIES - EXAMPLE IDENTIFICATION EXERCISE	201
VEGETABLE CATEGORIES - EXAMPLE IDENTIFICATION EXERCISE	202
VEGETABLE CATEGORIES - EXAMPLE IDENTIFICATION EXERCISE	203
VEGETABLE CATEGORIES - EXAMPLE IDENTIFICATION EXERCISE	204
VEGETABLE CATEGORIES - EXAMPLE IDENTIFICATION EXERCISE	205
VEGETABLE CATEGORIES - IMAGE CUT OUTS	206
LESSON PLAN - GUIDELINES FOR VEGETABLE COOKERY	208
GUIDELINES FOR VEGETABLE COOKERY	209
GUIDELINES FOR VEGETABLE COOKERY - PHRASE MATCH EXERCISE A	210
GUIDELINES FOR VEGETABLE COOKERY - PHRASE MATCH EXERCISE B	211
LESSON PLAN - PURCHASING & STORING FRESH VEGETABLES – FILL IN THE BLANKS	212
PURCHASING AND STORING FRESH VEGETABLES - EXERCISE	213
PURCHASING AND STORING FRESH VEGETABLES - ANSWERS	214
LESSON PLAN - DETERMINING DONENESS – FILL IN THE BLANKS	215
DETERMINING DONENESS - EXERCISE	216

DETERMINING DONENESS - ANSWERS	217
LESSON PLAN - STARCHES - STUDY SHEETS	218
STARCHES - STUDY SHEET - A	219
STARCHES - STUDY SHEET - B	220
LESSON PLAN - STARCHES - PICTURE MATCH	221
STARCHES - PICTURE MATCH - A	222
STARCHES - PICTURE MATCH - B	223
LESSON PLAN - STARCHES - DEFINITION MATCH	224
STARCHES - DEFINITION MATCH	225
STARCHES - DEFINITION MATCH - ANSWERS	226
LESSON PLAN - STARCHES - WORD SCRABBLE EXERCISE	227
STARCHES - WORD SCRABBLE EXERCISE	228
STARCHES - WORD SCRABBLE EXERCISE - ANSWERS	229
LESSON PLAN - STARCHES - WHEAT	230
WHEAT - READING AND COMPREHENSION EXERCISE	231
WHEAT - READING AND COMPREHENSION EXERCISE - ANSWERS	232
LESSON PLAN - STARCHES WORD SEARCH	233
STARCHES WORD SEARCH	234
STARCHES WORD SEARCH - ANSWERS	235
LESSON PLAN - STARCHES - NUMBERED WORD DEFINITION MATCH	236
STARCHES DEFINITIONS - NUMBERED WORD DEFINITION MATCH	237
STARCHES DEFINITIONS - NUMBERED WORD DEFINITION MATCH ANSWERS	238
LESSON PLAN - STARCHES - GRAINS	239
GRAINS - EXERCISE	240
GRAINS - EXERCISE ANSWERS	241
COLD KITCHEN - SALADS & DRESSINGS	242
LESSON PLAN - COLD KITCHEN STUDY SHEETS: SALAD GREENS, SALAD DRESSINGS, PREPARATION METHODS	243
COLD KITCHEN - STUDY SHEET	244
COLD KITCHEN - STUDY SHEET (CON'T)	245
COLD KITCHEN - STUDY SHEET (CON'T)	246
LESSON PLAN - COLD KITCHEN - FILL IN THE BLANKS	247

COLD KITCHEN - FILL IN THE BLANKS	248
COLD KITCHEN - FILL IN THE BLANKS - ANSWERS	249
LESSON PLAN - COLD KITCHEN - WORDMATCH	250
COLD KITCHEN - WORDMATCH	251
COLD KITCHEN - WORDMATCH - ANSWERS	252
LESSON PLAN - COLD KITCHEN - HIDDEN WORD PUZZLE	253
COLD KITCHEN - HIDDEN WORD PUZZLE	254
COLD KITCHEN - HIDDEN WORD PUZZLE - ANSWERS	255
LESSON PLAN - COLD KITCHEN - WORD SCRAMBLE	256
COLD KITCHEN - WORD SCRAMBLE	257
COLD KITCHEN - WORD SCRAMBLE - ANSWERS	258
LESSON PLAN - HOT OR COLD SANDWICHES - POSTER	259
HOT OR COLD SANDWICHES - 11 X 17 POSTER	260
HOT OR COLD SANDWICHES - EXERCISE	261
HOT OR COLD SANDWICHES - EXERCISE - ANSWERS	262
LESSON PLAN - SALAD DRESSINGS 101 - INTRODUCTION	263
SALAD DRESSINGS 101 - INTRODUCTION	264
SALAD DRESSINGS 101 - INTRODUCTION (CON'T)	265
SALAD DRESSINGS 101 - COVER PAGE	266
SALAD DRESSINGS 101 - CONTENTS PAGE	267
SALAD DRESSINGS 101 - DRESSINGS FOR ALL OCCASIONS - EXERCISE	268
SALAD DRESSINGS 101 - DRESSINGS FOR ALL OCCASIONS - EXERCISE	269
SALAD DRESSINGS 101 - DRESSINGS FOR ALL OCCASIONS - EXERCISE	270
SALAD DRESSINGS 101 - DRESSINGS FOR ALL OCCASIONS - ANSWERS	271
SALAD DRESSINGS 101 - DRESSINGS FOR ALL OCCASIONS - ANSWERS	272
SALAD DRESSINGS 101 - DRESSINGS FOR ALL OCCASIONS - ANSWERS	273
SEAFOOD COOKERY	274
LESSON PLAN - FISH STRUCTURE & MUSCLE COMPOSITION - FILL IN THE BLANKS	275
FISH STRUCTURE AND MUSCLE COMPOSITION - FILL IN THE BLANKS	276
FISH STRUCTURE AND MUSCLE COMPOSITION - ANSWERS	277
LESSON PLAN - FLAT FISH BONE STRUCTURE - PART NAMES	278

FLAT FISH BONE STRUCTURE - PART NAMES	279
BONE STRUCTURE OF FLAT FISH - EXERCISE	280
BONE STRUCTURE OF FLAT FISH - ANSWERS	281
LESSON PLAN - ROUND FISH BONE STRUCTURE - PART NAMES	282
ROUND FISH BONE STRUCTURE - PART NAMES	283
BONE STRUCTURE OF ROUND FISH - EXERCISE	284
BONE STRUCTURE OF ROUND FISH - ANSWERS	285
LESSON PLAN - ROUND FISH, FLAT FISH, MOLLUSKS & CRUSTACEANS STUDY BOOKLET	286
ROUND FISH - IMAGES AND DESCRIPTION	287
ROUND FISH - IMAGES AND DESCRIPTION (CON'T)	288
ROUND FISH - IMAGES AND DESCRIPTION (CON'T)	289
ROUND FISH - IMAGES AND DESCRIPTION (CON'T)	290
FLAT FISH - IMAGES AND DESCRIPTION	291
FLAT FISH - IMAGES AND DESCRIPTION (CON'T)	292
MOLLUSKS - IMAGES AND DESCRIPTION	293
MOLLUSKS - IMAGES AND DESCRIPTION (CON'T)	294
MOLLUSKS - IMAGES AND DESCRIPTION (CON'T)	295
CRUSTACEANS - IMAGES AND DESCRIPTION	296
CRUSTACEANS - IMAGES AND DESCRIPTION (CON'T)	297
CRUSTACEANS - IMAGES AND DESCRIPTION (CON'T)	298
MEAT & POULTRY COOKERY	299
LESSON PLAN - DRY-HEAT COOKING METHODS FOR MEATS – FILL IN THE BLANKS	300
DRY-HEAT COOKING METHODS FOR MEATS - EXERCISE	301
DRY-HEAT COOKING METHODS FOR MEATS - ANSWERS	302
LESSON PLAN - ROASTING EQUIPMENT – FILL IN THE BLANKS	303
ROASTING EQUIPMENT - EXERCISE	304
ROASTING EQUIPMENT - ANSWERS	305
LESSON PLAN - ROASTING MEAT IN THE OVEN	306
ROASTING MEAT IN THE OVEN	307
ROASTING MEAT IN THE OVEN - ACTIVITY SET	308
ROASTING MEAT IN THE OVEN - ACTIVITY SET - ANSWERS	309

LESSON PLAN - JUS AND GRAVIES – FILL IN THE BLANKS	310
JUS & GRAVIES - ACTIVITY SET	311
JUS & GRAVIES - ACTIVITY SET - ANSWERS	312
LESSON PLAN - JUS LIÉ – 7 STEPS FOR PREPARING JUS LIÉ	313
JUS LIÉ	314
JUS LIÉ - EXERCISE	315
LESSON PLAN - BROILING MEAT – FILL IN THE BLANKS	316
BROILING MEAT - ACTIVITY SET	317
BROILING MEAT - ACTIVITY SET - ANSWERS	318
LESSON PLAN - CHAR-BROILING MEATS – 6 STEPS FOR CHAR-BROILING MEATS	319
CHAR-BROILING MEATS	320
CHAR-BROILING MEATS - EXERCISE	321
LESSON PLAN - DETERMINING DONENESS CHAR-BROILED MEATS: READING COMPREHENSION EXERCISE	322
DETERMINING DONENESS FOR CHAR-BROILED MEATS	323
DETERMINING DONENESS FOR CHAR-BROILED MEATS - ACTIVITY SET	324
DETERMINING DONENESS FOR CHAR-BROILED MEATS - ANSWERS	325
LESSON PLAN - GRIDDLING MEATS – 6 STEPS FOR GRIDDLING MEATS	326
GRIDDLING MEATS	327
GRIDDLING MEATS - GROUP SORT EXERCISE	328
LESSON PLAN - SAUTÉING - 6 GENERAL PROCEDURES FOR SAUTÉING	329
SAUTÉING	330
SAUTÉING - GROUP SORT EXERCISE	331
LESSON PLAN - PAN FRYING - FILL IN THE BLANKS	332
PAN FRYING - EXERCISE	333
PAN FRYING - ANSWERS	334
LESSON PLAN - DRY-HEAT COOKING METHODS FOR POULTRY – FILL IN THE BLANKS	335
DRY-HEAT COOKING METHODS FOR POULTRY - EXERCISE	336
DRY-HEAT COOKING METHODS FOR POULTRY - ANSWERS	337
LESSON PLAN - POULTRY VOCABULARY - TERM/DEFINITION MATCH	338
POULTRY VOCABULARY	339
POULTRY VOCABULARY - TERMS & DETAILS MATCH	340

LESSON PLAN - ROASTING POULTRY - FILL IN THE BLANKS	341
ROASTING POULTRY - EXERCISE	342
ROASTING POULTRY - ANSWERS	343
LESSON PLAN - BROILING/GRILLING POULTRY - FILL IN THE BLANKS	344
BROILING/GRILLING POULTRY - EXERCISE	345
BROILING/GRILLING POULTRY - ANSWERS	346
LESSON PLAN - SAUTÉING POULTRY - 5 GUIDELINES FOR SAUTÉING POULTRY	347
SAUTÉING POULTRY	348
SAUTÉING POULTRY - EXERCISE	349
LESSON PLAN - PAN FRYING POULTRY - FILL IN THE BLANKS	350
PAN FRYING POULTRY - EXERCISE	351
PAN FRYING POULTRY - ANSWERS	352
LESSON PLAN - DEEP FRYING POULTRY - FILL IN THE BLANKS	353
DEEP FRYING POULTRY - EXERCISE	354
DEEP FRYING POULTRY - ANSWERS	355
LESSON PLAN - PRESSURE DEEP FAT FRYING - FILL IN THE BLANKS	356
PRESSURE DEEP FAT FRYING - EXERCISE	357
PRESSURE DEEP FAT FRYING - ANSWERS	358
LESSON PLAN - MOISTURE-HEAT COOKING METHODS FOR MEAT & POULTRY – FILL IN THE BLANKS	359
MOIST-HEAT COOKING METHODS FOR MEAT AND POULTRY - EXERCISE	360
MOIST-HEAT COOKING METHODS FOR MEAT AND POULTRY - ANSWERS	361
LESSON PLAN - MOIST-HEAT COOKING METHODS FOR MEAT – TERM/DEFINITION MATCH	362
MOIST-HEAT COOKING METHODS FOR MEAT – TERMS/DEFINITIONS/EXAMPLES - STUDY SHEET	363
MOIST-HEAT COOKING METHODS FOR MEAT – TERMS/DEFINITIONS/EXAMPLES - EXERCISE	364
MOIST-HEAT COOKING METHODS FOR POULTRY – TERMS/DEFINITIONS/EXAMPLES - STUDY SHEET	365
MOIST-HEAT COOKING METHODS FOR POULTRY – TERMS/DEFINITIONS/EXAMPLES - EXERCISE	366
LESSON PLAN - COMBINATION HEAT COOKING METHODS - FILL IN THE BLANKS	367
COMBINATION HEAT COOKING METHODS - EXERCISE	368
COMBINATION HEAT COOKING METHODS - ANSWERS	369
LESSON PLAN - COMBINATION COOKING METHODS MEAT & POULTRY – TERM/DEFINITION MATCH	370
COMBINATION COOKING METHODS FOR MEAT AND POULTRY – TERMS/DEFINITIONS - STUDY SHEET	371

COMBINATION COOKING METHODS FOR MEAT AND POULTRY – TERMS/DEFINITIONS - EXERCISE	372
LESSON PLAN - COMBINATION COOKING REFERENCE CHART	373
COMBINATION HEAT COOKING REFERENCE CHART	374
LESSON PLAN - PRIMAL CUTS OF BEEF – FILL IN THE PARTS EXERCISE	375
PRIMAL CUTS OF BEEF - CHART	376
PRIMAL CUTS OF BEEF - FILL IN THE PARTS EXERCISE	377
LESSON PLAN - SECONDARY CUTS OF BEEF – FILL IN THE PARTS EXERCISE	378
SECONDARY CUTS OF BEEF - CHART	379
SECONDARY CUTS OF BEEF - FILL IN THE PARTS EXERCISE	380
LESSON PLAN - PRIMAL CUTS OF PORK – FILL IN THE PARTS EXERCISE	381
PRIMAL CUTS OF A SIDE OF PORK - STUDY SHEET	382
PRIMAL CUTS OF A SIDE OF PORK - NAME THE PART	383
LESSON PLAN - SECONDARY CUTS OF PORK – NAME THE SECONDARY CUTS	384
SECONDARY CUTS OF PORK - STUDY SHEET	385
SECONDARY CUTS OF PORK - NAME THE SECONDARY CUTS	386
SECONDARY CUTS OF PORK - NAME THE PRIMAL CUTS	387
LESSON PLAN - MEAT CUTS WORD SEARCH	388
MEAT CUTS WORD SEARCH	389
MEAT CUTS WORD SEARCH - ANSWERS	390
BASIC FOOD SERVICE & KITCHEN MANAGEMENT	391
LESSON PLAN - BASIC COOKING PRINCIPLES - EXERCISE	392
BASIC COOKING PRINCIPLES - EXERCISE	393
BASIC COOKING PRINCIPLES - ANSWERS	394
LESSON PLAN - BASIC METHODS OF COOKING - STUDY SHEET - EXERCISE	395
BASIC METHODS OF COOKING - STUDY SHEET	396
BASIC METHODS OF COOKING - EXERCISE 1	397
BASIC METHODS OF COOKING - STUDY SHEET	398
LESSON PLAN - BASIC SEASONING & FLAVOURING TECHNIQUES	399
BASIC SEASONING AND FLAVOURING TECHNIQUES – STUDY SHEET	400
BASIC SEASONING AND FLAVOURING TECHNIQUES – WORDMATCH	401
BASIC SEASONING AND FLAVOURING TECHNIQUES – EXERCISE	403

LESSON PLAN - AM I A SPICE OR AN HERB?	404
BASIC SEASONING AND FLAVOURING TECHNIQUES – EXERCISE	405
AM I A SPICE OR HERB - EXERCISE	406
AM I A SPICE OR HERB - ANSWERS	407
LESSON PLAN - RECEIVING METHODS - EXERCISE	408
RECEIVING METHODS - EXERCISE	409
RECEIVING METHODS - ANSWERS	410
LESSON PLAN - INVOICES - EXERCISE	411
INVOICES - EXERCISE	412
INVOICES - ANSWERS	413
LESSON PLAN - RECEIVING PRACTICES – PHRASE MATCH	414
RECEIVING PRACTICES – STUDY SHEET	415
RECEIVING PRACTICES – PHRASE MATCH	416
LESSON PLAN - SUGGESTED RECEIVING METHODS – QUESTIONNAIRE	417
SUGGESTED RECEIVING METHODS – READING EXERCISE	418
SUGGESTED RECEIVING METHODS – QUESTIONNAIRE	419
SUGGESTED RECEIVING METHODS – ANSWERS	420
LESSON PLAN - STORING METHODS – STUDY SHEET - A/B/C	421
STORING METHODS – STUDY SHEET - A	422
STORING METHODS – STUDY SHEET - B	423
STORING METHODS – STUDY SHEET - C	424
STORING METHODS – EXERCISE 1	425
STORING METHODS – EXERCISE 1 - SAMPLE	426
STORING METHODS – EXERCISE 2	427
STORING METHODS – EXERCISE 2 ANSWERS	428
LESSON PLAN - FOOD DETERIORATION	429
FOOD DETERIORATION – STUDY SHEET	430
FOOD DETERIORATION – EXERCISE 1	431
FOOD DETERIORATION – EXERCISE 1 - ANSWERS	432
LESSON PLAN - FOOD DETERIORATION – WHAT DOES IT LOOK LIKE WHEN IT IS GOING BAD?	433
FOOD DETERIORATION – WHAT DOES IT LOOK LIKE WHEN IT IS GOING BAD?	434

FOOD DETERIORATION – WHAT DOES IT LOOK LIKE WHEN IT IS GOING BAD? - EXERCISE	435
FOOD DETERIORATION – WHAT DOES IT LOOK LIKE WHEN IT IS GOING BAD? ANSWERS	436
LESSON PLAN - REDUCE – REUSE – RECYCLE METHODS	437
REDUCE – REUSE – RECYCLE METHODS - STUDY SHEET	438
REDUCE – REUSE – RECYCLE METHODS - EXERCISE 1	439
REDUCE – REUSE – RECYCLE METHODS - EXERCISE 1 - SAMPLE ANSWER	440
LESSON PLAN - REDUCE – REUSE – RECYCLE METHODS	441
WORKING WITH OTHERS TO REDUCE, REUSE AND RECYCLE IN THE WORKPLACE	442
WORKING WITH OTHERS TO REDUCE, REUSE AND RECYCLE IN THE WORKPLACE	443
WORKING WITH OTHERS TO REDUCE, REUSE AND RECYCLE IN THE WORKPLACE	444
BASIC BAKING	445
LESSON PLAN - FUNDAMENTAL RULE OF BAKING, FLOURS, FATS, STARCHES, LEAVENING AGENTS	446
FUNDAMENTAL RULE OF BAKING	447
FLOURS	448
FATS	449
STARCHES	450
LEAVENING AGENTS	451
LESSON PLAN - BASIC PRINCIPLES OF BAKING - QUIZ CARDS	452
BASIC PRINCIPLES OF BAKING - QUIZ CARDS	453
LESSON PLAN - PIE DOUGH – FILL IN THE BLANKS	456
PIE DOUGH - EXERCISE	457
PIE DOUGH - EXERCISE ANSWERS	458
LESSON PLAN - WHAT HAPPENED TO MY PIE CRUST?	459
WHAT HAPPENED TO MY PIE DOUGH?	460
WHAT HAPPENED TO MY PIE DOUGH? - PHRASE MATCH EXERCISE	461
LESSON PLAN - COMMON TYPES OF PIE DOUGH	462
COMMON TYPES OF PIE DOUGH - STUDY SHEET	463
COMMON TYPES OF PIE DOUGH - EXERCISE	464
COMMON TYPES OF PIE DOUGH - ANSWERS	465
LESSON PLAN - UNBAKED AND BAKED PIES	466
UNBAKED AND BAKED PIES - STUDY SHEET	467

UNBAKED AND BAKED PIES - QUESTIONNAIRE	468
UNBAKED AND BAKED PIES - ANSWERS	469
LESSON PLAN - QUICK BREADS – MUFFIN METHOD & BISCUIT METHOD	470
QUICK BREADS – MUFFIN METHOD AND BISCUIT METHOD STUDY SHEET	471
QUICK BREADS – MUFFIN METHOD EXERCISE	472
QUICK BREADS – BISCUIT METHOD EXERCISE	473
REFERENCES	474
ATTRIBUTIONS	475
SPECIAL THANKS	503
RESOURCES	504
PROFESSIONALISM - CHEFS AND RESTAURANTS - WORDMATCH	504
PROFESSIONALISM - CULINARY FRENCH VOCABULARY - WORDMATCH	505
PROFESSIONALISM - THE CLASSIC KITCHEN VOCABULARY - WORDMATCH	506
SOUPS, STOCKS & SAUCES - STOCKS - WORDMATCH EXERCISE	507
MEAT & POULTRY COOKERY - POULTRY VOCABULARY - TERMS & DETAILS MATCH	508
BFS & KM - BASIC SEASONING AND FLAVOURING TECHNIQUES – WORDMATCH	509
11 X 17 POSTERS & BOARD GAMES	510
PAGE 68 - TEMPATURE DANGER ZONE - 11 X 17 POSTER	510
PAGE 72 - PROPER HANDWASHING PROCEDURE - 11 X 17 POSTER	510
PAGE 77 - SAFE BEHAVIOUR ON THE JOB - 11 X 17 POSTER	510
PAGE 148 - SHOOTS & LADDERS EXERCISE - 11 X 17 BOARD GAME	510
PAGE 260 - HOT & COLD SANDWICHES - 11 X 17 POSTER	510





PROFESSIONALISM



LESSON PLAN - CHEFS AND RESTAURANTS - WORD/DEFINITION MATCH

From the kitchen of **PROFESSIONALISM**

■ Purpose and Practice:

- Matching Chefs and Restaurant related vocabulary to definitions
- Pronunciation of French words related to the subject
- Studying and memorizing pertinent names of historical chefs and restaurant terms

■ Ingredients

Page 9 (handout)

Pages 10, 11, 12
(9 vocabulary/
definition cut outs
– to make sets for
group work)

■ Method

- Instructor prepares appropriate number of sets of the 9 terms by photocopying the 9 “Chef Heads” and cutting them out along the dotted lines so that the top of the chef hat (vocabulary word) is separated from the chef face (definition).
- Shuffle word and definitions so that they are not in order
- Distribute a complete (shuffled) set to each group (2 to 5 students per group)
- Invite each group to work together (encouraging total participation) to match the correct term (chef hat) to the correct definition of the term (chef face).
- Once matched, invite the groups to practice the pronunciation of the French terms/words; (i.e. “restaurer” sounds like “res-taw-ray”).
- Come together as a whole class to review matches and practice pronunciation together.
- Provide each learner with a copy of the handout called “Chefs and Restaurants - (page 9)

■ Cooking Time

45 - 60 minutes



■ Essential Skills being practiced

- ✓ Thinking Skills
- ✓ Working With Others
- ✓ Oral Communication
- ✓ Document Use
- ✓ Reading Text

Tip:

To avoid mixing up sets for future use, tag each one for easy re-set and shuffle. For example, each piece of set #1 has a blue dot on each piece, set #2 a red dot, etc.

CHEFS AND RESTAURANTS

Vocabulary	Description
<p>Restaurer (sounds like...res-taw-ray)</p>	<p>Where the French word “restaurant” comes from meaning “to restore”.</p>
<p>Monsieur Boulanger (sounds like... Mon-see-ur Boo-lan-jay)</p>	<p>A French tavern keeper who the French claim opened the first modern restaurant in 1765.</p>
<p>Antoine Beauvilliers (sounds like... An-twon Bo-vee-lee-ay)</p>	<p>In 1782, he advanced the development of the modern restaurant by offering his wealthy customers a menu of dishes during fixed hours and served by highly trained wait staff.</p>
<p>Antonin Careme (sounds like... An-to-nayn Ka-rem)</p>	<p>19th century designed meals that involved complex multiple courses that were prepared in great detail and special presentation with garnishes and sauces. Became to be known as “grande cuisine”. Known as the “cook of kings and the king of cooks”!</p>
<p>Cuisine (sounds like...kwi-zeen)</p>	<p>Cooking procedures, styles, ingredients and seasonings typical to a particular group of people.</p>
<p>Charles Ranhofer</p>	<p>The first internationally renowned chef of an American restaurant. In 1893, he published a “franco-american” encyclopedia of cooking called “The Epicurean” which contained more than 3,500 recipes.</p>
<p>Epicure</p>	<p>A person who appreciates fine food and drink.</p>
<p>Auguste Escoffier (sounds like... Ah-goost Es-ko-fee-ay)</p>	<p>He refined the “haute cuisine” of Careme to create “cuisine classique” or “classic cuisine”. He brought French cuisine into the 20th century.</p>
<p>Fernand Point (sounds like... Fer-nand Pway)</p>	<p>A mid-20th century leader of “Nouvelle Cuisine” which was a trend toward lighter, more naturally flavoured and more simply prepared foods.</p>

CHEFS AND RESTAURANTS - WORDMATCH

Restaurer
(sounds like... res-taw-ray)

Where the French word
"restaurant" comes from
meaning "to restore".

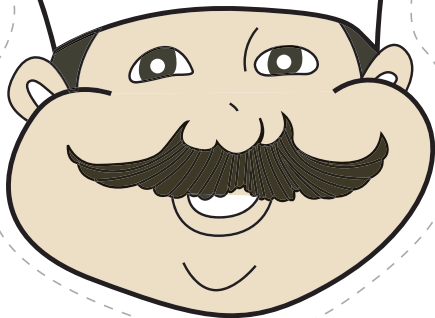

Monsieur Boulanger
(sounds like... Mon-see-ur Boo-lan-jay)

A French tavern keeper who
the French claim opened the
first modern restaurant in
1765.

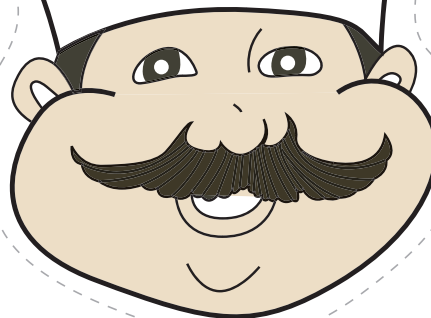

Antoine Beauvilliers
(sounds like... An-twon Bo-vee-lee-ay)

In 1782, he advanced the
development of the modern
restaurant by offering his wealthy
customers a menu of dishes
during fixed hours and served by
highly trained wait staff.

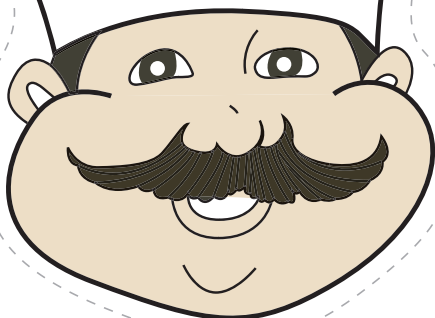

Antonin Careme
(sounds like... An-to-nayn Ka-rem)

19th century designed meals that involved complex multiple courses that were prepared in great detail and special presentation with garnishes and sauces. Became to be known as "grande cuisine". Known as the "cook of kings and the king of cooks"!

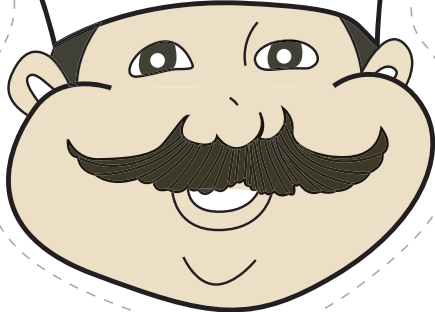

Cuisine
(sounds like... kwi-zeen)

Cooking procedures, styles, ingredients and seasonings typical to a particular group of people.

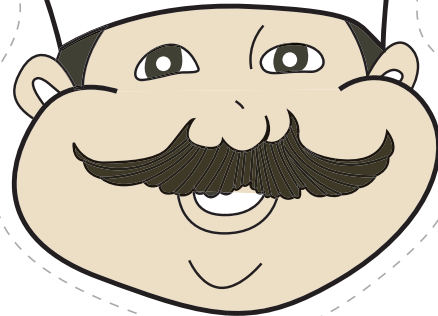

Charles Ranhofer

The first internationally renowned chef of an American restaurant. In 1893, he published a "franco-american" encyclopedia of cooking called "The Epicurean" which contained more than 3,500 recipes.

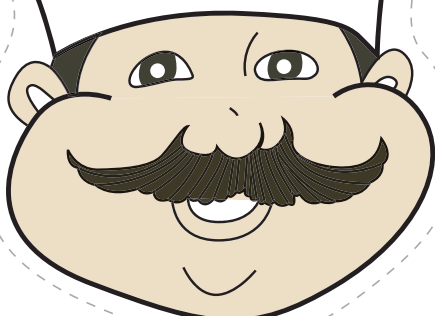

Epicure

A person who appreciates fine food and drink.

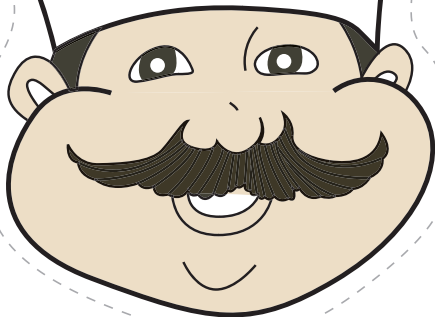

Auguste Escoffier
(sounds like... Ah-goost Es-ko-fee-ay)

He refined the "haute cuisine" of Careme to create "cuisine classique" or "classic cuisine". He brought French cuisine into the 20th century.

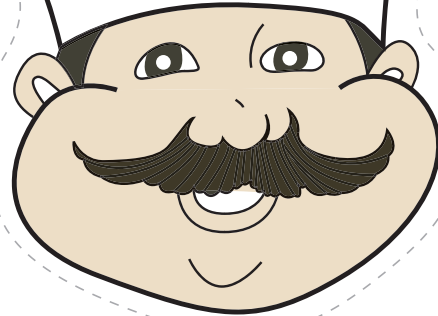

Fernand Point
(sounds like... Fer-nand Pway)

A mid-20th century leader of "Nouvelle Cuisine" which was a trend toward lighter, more naturally flavoured and more simply prepared foods.

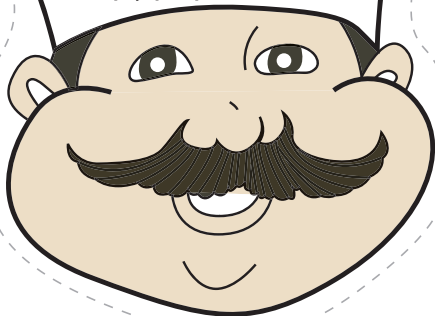

LESSON PLAN - CULINARY FRENCH VOCABULARY - WORD/DEFINITION MATCH



From the kitchen of **PROFESSIONALISM**

■ Purpose and Practice:

- Matching 17 culinary terms to definitions
- Pronunciation of French words related to cooking
- Studying and memorizing pertinent vocabulary to its proper definition
- Working with others to accomplish a task

■ Ingredients

Page 14 (handout)

Pages 15, 16, 17,
18, 19

(17 vocabulary/
definition cut outs
– to make sets for
group work)

■ Method

- Instructor prepares appropriate number of sets of the 17 terms by photocopying the 17 pots and cutting them out along the dotted lines so that the lid of the pot (vocabulary word) is separated from the bottom of the pot (definition).
- Shuffle word and definitions so that they are not in order
- Distribute a complete (shuffled) set to each group (2 to 5 students per group)
- Invite each group to work together (encouraging total participation) to match the correct term (pot lid) to the correct definition (pot).
- Once matched, invite the groups to practice the pronunciation of the French terms/words; (i.e. “bain marie sounds like “bayn maree”).
- Come together as a whole class to review matches and practice pronunciation together.
- Provide each learner with a copy of the handout called “Culinary French Vocabulary” page 14.

■ Cooking Time

45 - 60 minutes

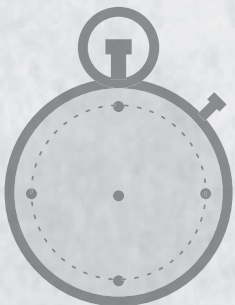

■ Essential Skills being practiced

- ✓ Thinking Skills
- ✓ Working With Others
- ✓ Oral Communication
- ✓ Document Use
- ✓ Reading Text

Tip:

To avoid mixing up sets for future use, tag each one for easy re-set and shuffle. For example, each piece of set #1 has a blue dot on each piece, set #2 a red dot, etc.

CULINARY FRENCH VOCABULARY

Vocabulary	Description
Bain marie <i>(sounds like...bayn maree)</i>	A hot water bath for gently cooking foods or keeping cooked foods hot.
Brunoise <i>(sounds like...broo-nwhaz)</i>	Cube shaped cuts of vegetables or other foods.
Canape <i>(sounds like...ka-na-pay)</i>	An appetizer usually made from a small piece of bread or toast topped with a spread or garnish.
Garnish	Food used to decorate or add flavor to the main ingredients in a dish.
Demi-glaze <i>(sounds like...de-mee glahs)</i>	A mixture of brown stock and brown sauce reduced by half. ("half glaze")
Reduction	Cooking a liquid until it decreases through evaporation.
Ganache <i>(sounds like...ga-nash)</i>	A rich pastry or candy filling made with chocolate, heavy cream and other flavourings.
Julienne <i>(sounds like...joo-lee-ehn)</i>	Stick-shaped cuts
Mayonnaise	A sauce made of egg yolks and oil and seasoned with vinegar, mustard and seasonings.
Mirepoix <i>(sounds like...mih-rpwah)</i>	A mixture of onions, carrots and celery, used to flavour soup stocks, stews and other dishes.
Mise en place <i>(sounds like...meez-an-plahs)</i>	"Everything in place" meaning the preparation and assembly of all ingredients and equipment needed before a dish can be cooked.
Puree <i>(sounds like...pyu-ray)</i>	Food that is processed by mashing, straining or fine chopping until it is a smooth pulp.
Rondeau <i>(sounds like...rondo)</i>	A shallow, wide, straightsided pot with two loop handles.
Roux <i>(sounds like...roo)</i>	A thickener for sauces made by cooking together equal weights of fat and flour.
Sachet <i>(sounds like...sa-shay)</i>	A "bag of spices" ingredients such as bay leaf, thyme, cloves, peppercorns and parsley stems, tied in a cheesecloth bag and used to flavour stocks and other dishes.
Sauté <i>(sounds like...saw-tay)</i>	To cook in an open pan in a small amount of fat at a high temperature.
Vinaigrette <i>(sounds like...vee-nay-gret)</i>	A temporary emulsion of oil and vinegar seasoned with herbs, spices and other flavourings.

CULINARY FRENCH VOCABULARY - WORDMATCH

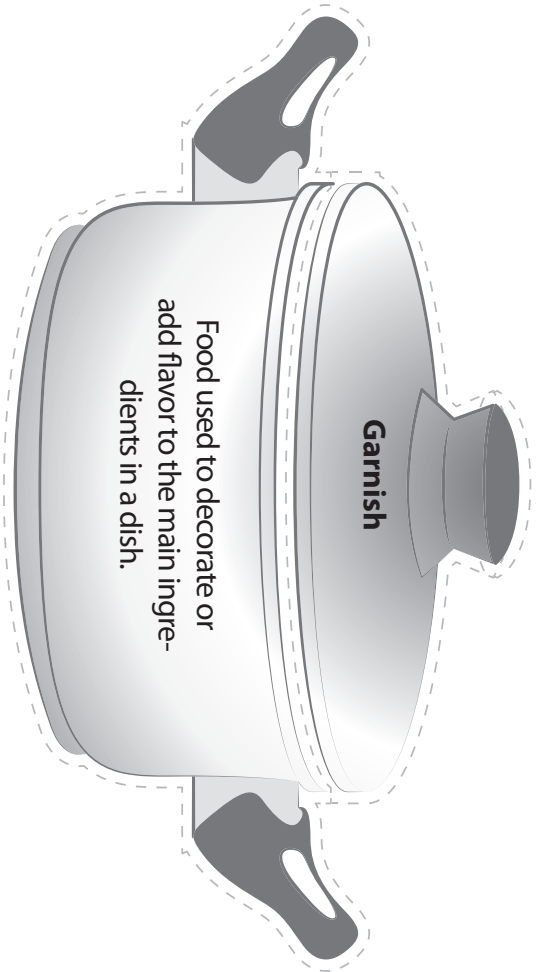
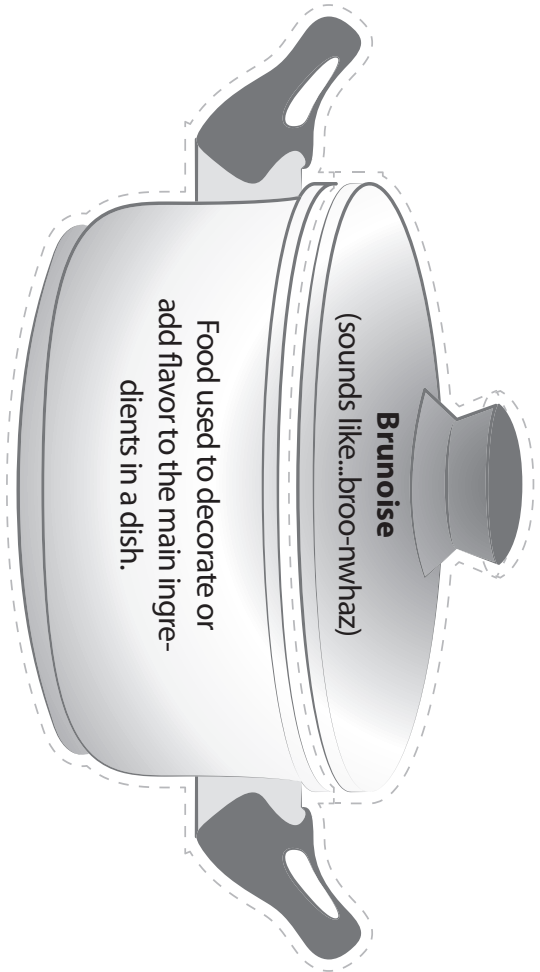
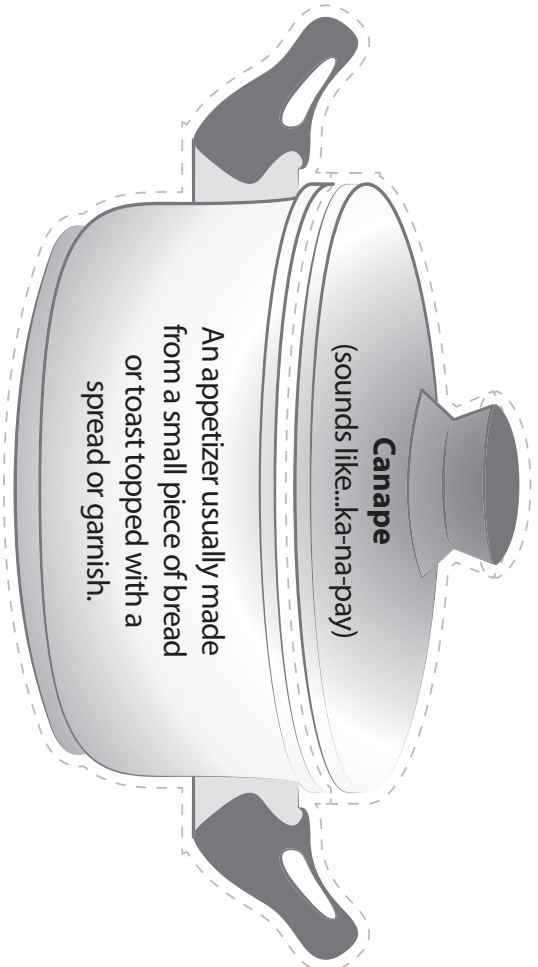
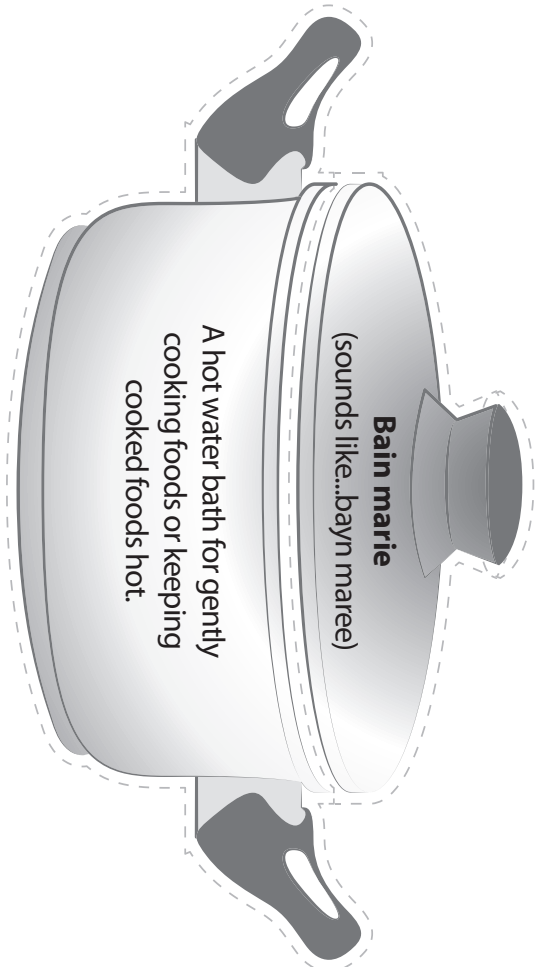

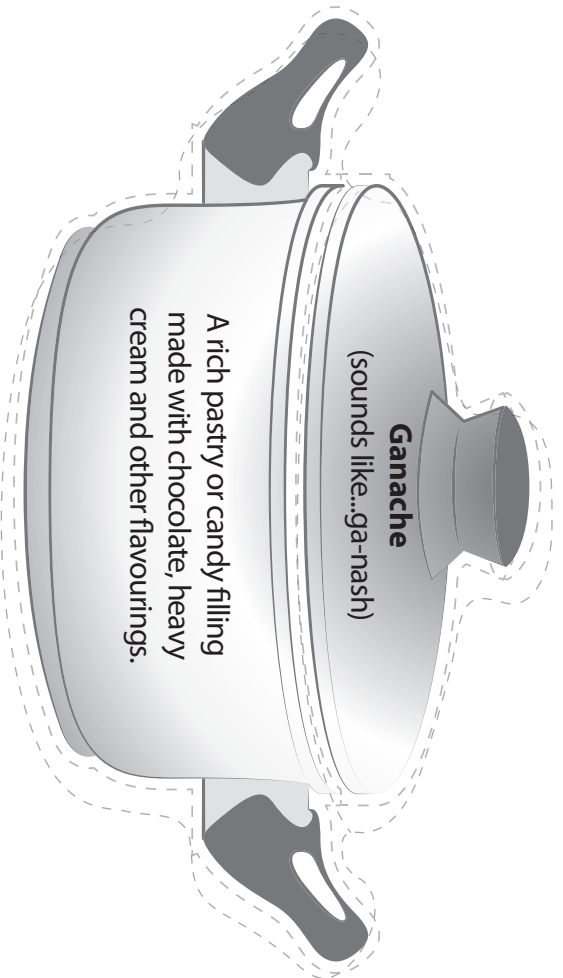
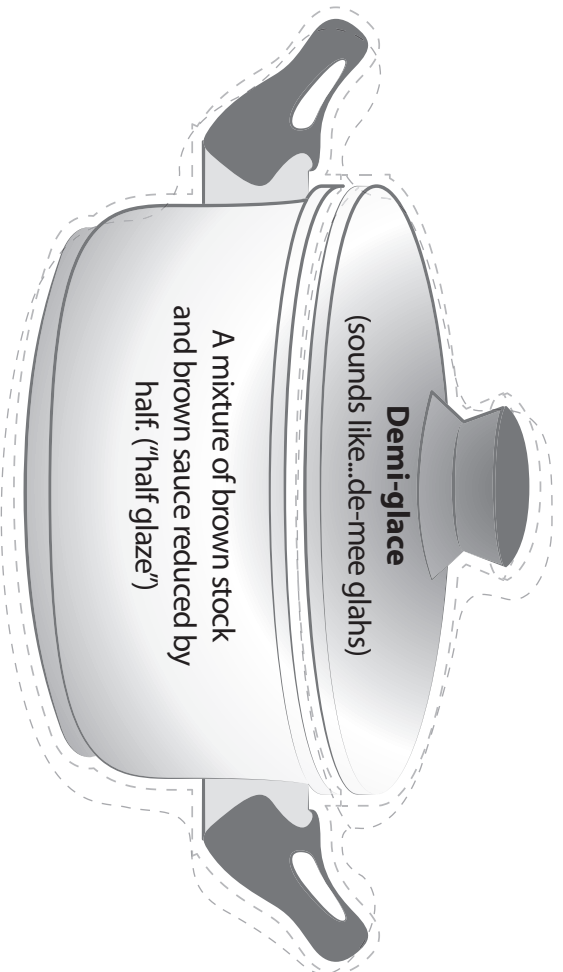
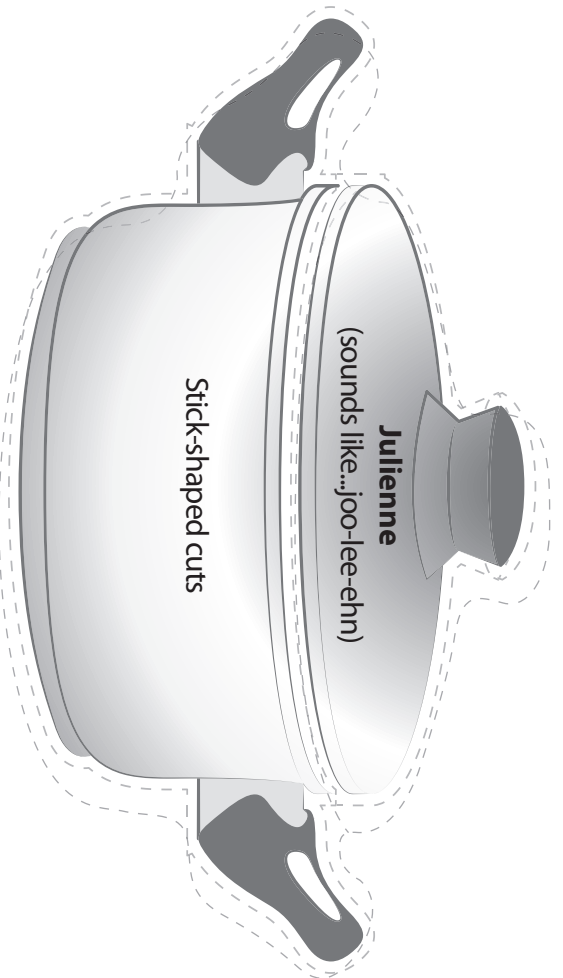
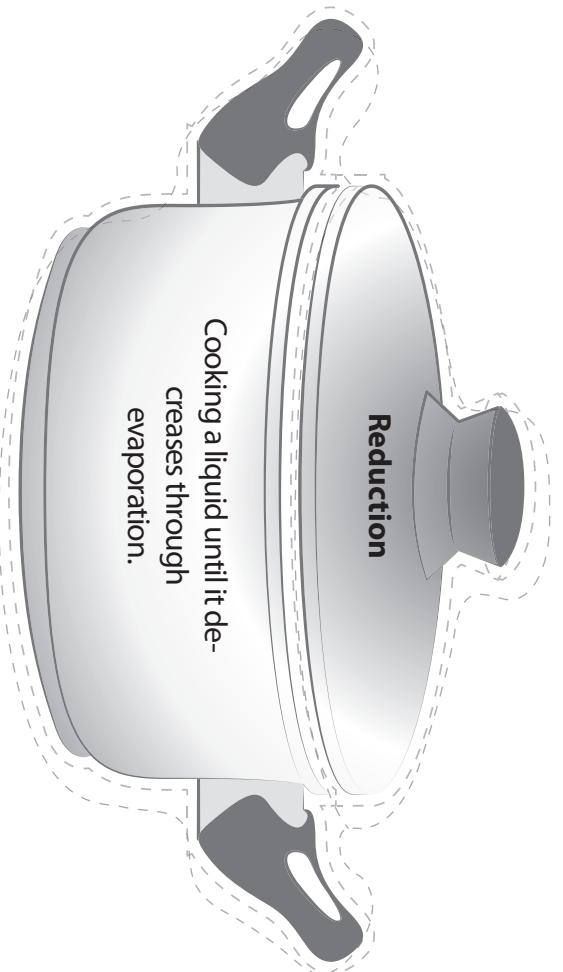

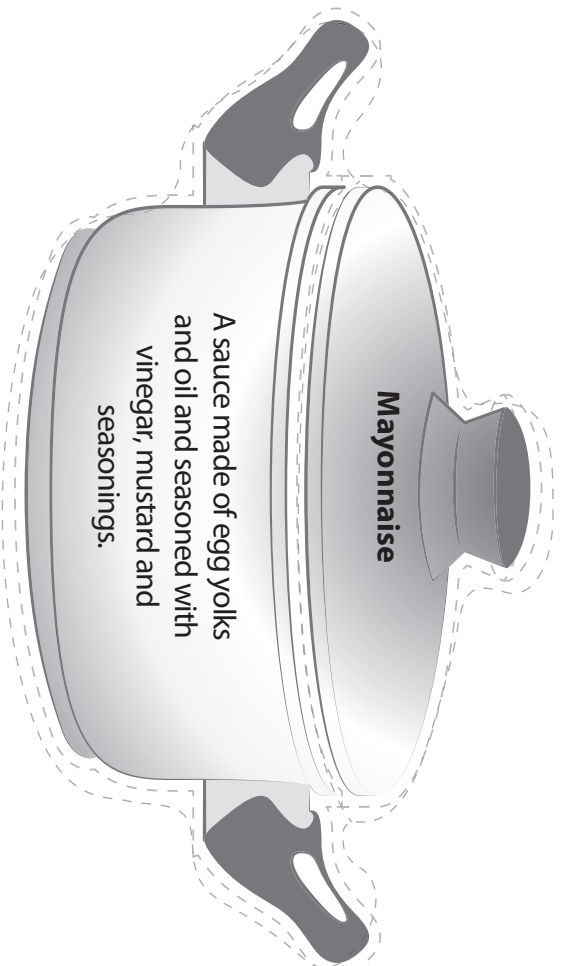
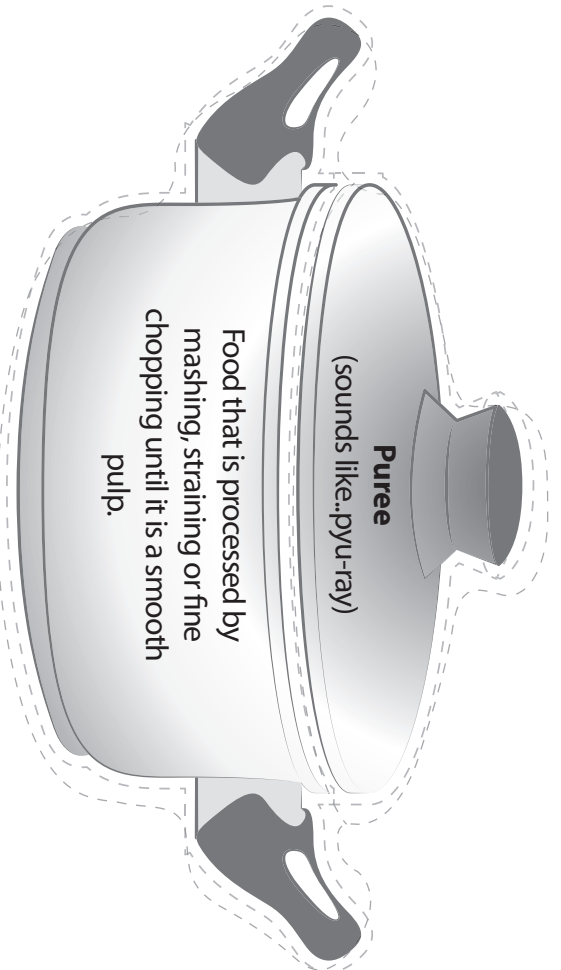
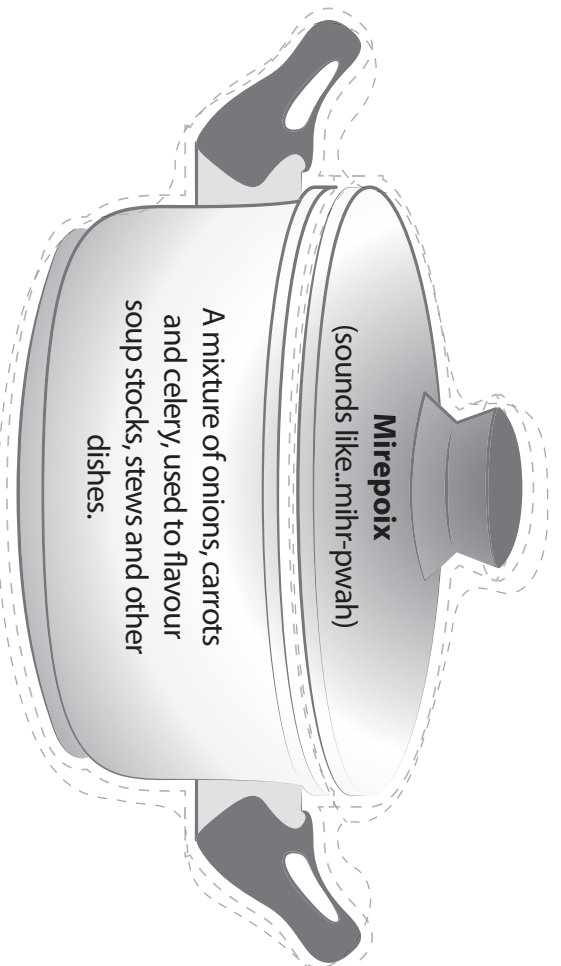

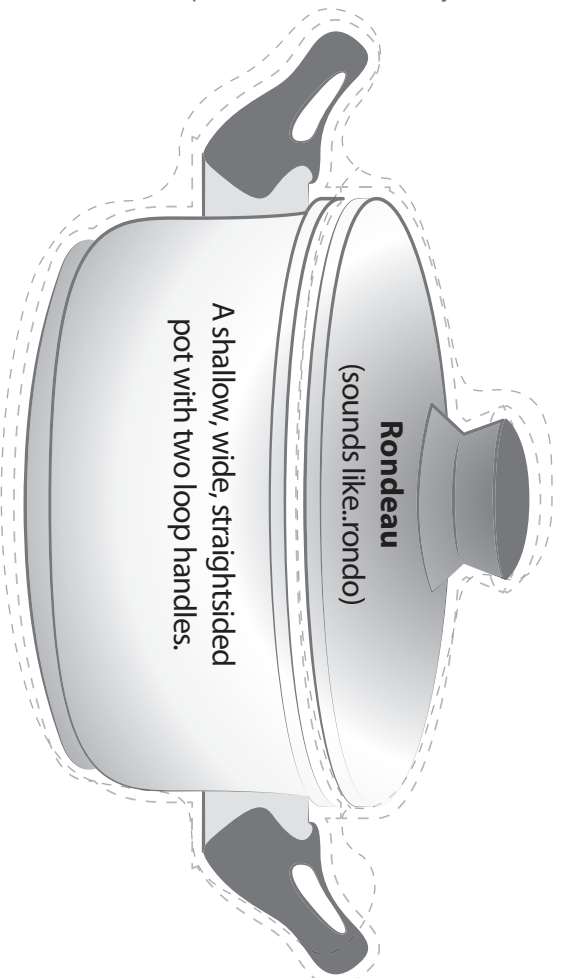
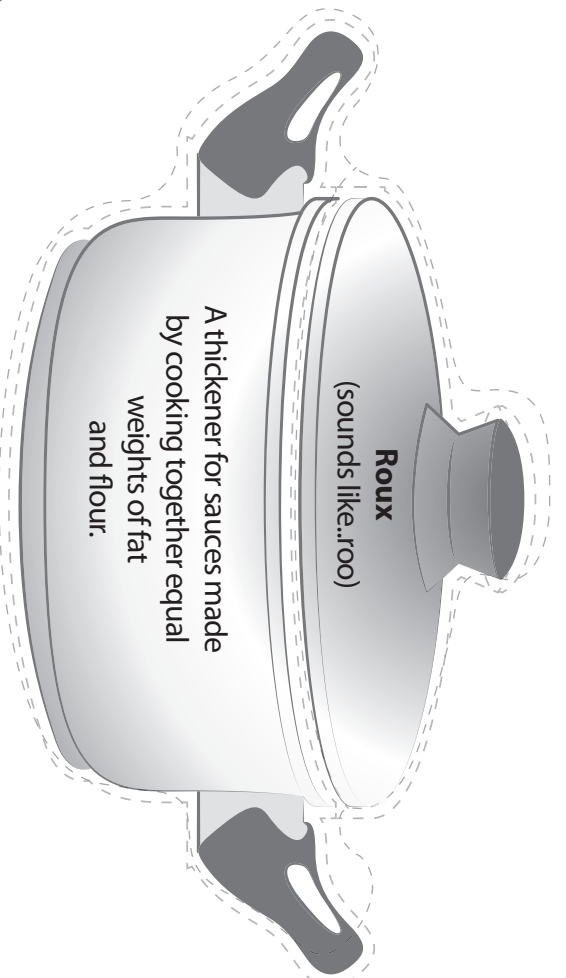

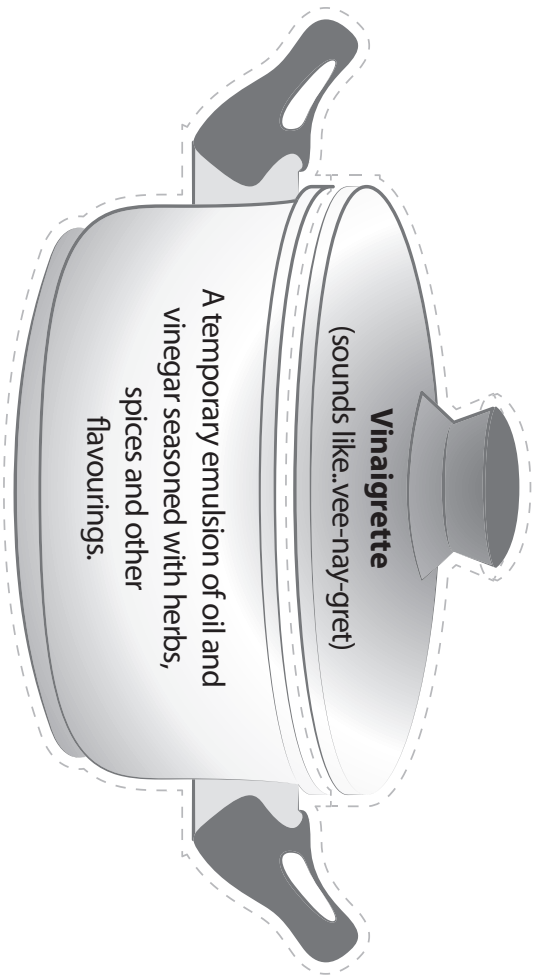



**LESSON PLAN - THE CLASSIC & MODERN KITCHEN
VOCABULARY - WORD/DEFINITION MATCH**

From the kitchen of **PROFESSIONALISM**

■ Purpose and Practice:

- Matching Classic and Modern kitchen related vocabulary to definitions
- Pronunciation of French words related to the subject
- Studying and memorizing pertinent names of Classic and Modern kitchen terms

■ Ingredients

Page 21 (handout)

Pages 22, 23, 24

(4 Classic Kitchen terms and 8 Modern Kitchen terms)

■ Method

- Instructor prepares appropriate number of sets of the terms photocopying the 12 chef hats and cutting them out along the dotted lines so that the top of the chef hat (vocabulary word) is separated from the bottom of the chef hat (definition).
- Shuffle word and definitions so that they are not in order
- Distribute a complete (shuffled) set to each group (2 to 5 students per group)
- Invite each group to work together (encouraging total participation) to match the correct term (top of chef hat) to the correct definition (bottom of chef hat).
- In the case of the Classic Kitchen terms, invite the groups to practice the pronunciation of the French terms/words; (i.e. "saucier" sounds like "saw-see-ay").
- Come together as a whole class to review matches and practice pronunciation together.
- Provide each learner with a copy of the handout called "The Classic and Modern Kitchen Vocabulary" (page 21)

■ Cooking Time

20 minutes for Classic Kitchen terms and 40 minutes for Modern Kitchen terms (separate the two).



■ Essential Skills being practiced

- ✓ Thinking Skills
- ✓ Working With Others
- ✓ Oral Communication
- ✓ Document Use
- ✓ Reading Text

Tip:

To avoid mixing up sets for future use, tag each one for easy re-set and shuffle. For example, each piece of set #1 has a blue dot on each piece, set #2 a red dot, etc.

THE CLASSIC & MODERN KITCHEN VOCABULARY

The Classic Kitchen Vocabulary	Description
The saucier <i>(sounds like...saw-see-ay)</i>	One who is responsible for all sautéed items and most sauces.
The Entremetier <i>(sounds like...en-tr-met-tee-ay)</i>	One who is responsible for vegetables, starches and soups.
The garde-manger <i>(sounds like...guard-mon-jay)</i>	One who is responsible for buffets and cold preparations as well as butchering meats and poultry.
The patissier <i>(sounds like...paw-tees-see-ay)</i>	One who is responsible for all baked items including breads, pastries and desserts.

The Modern Kitchen Vocabulary	Description
The Executive Chef	Coordinates kitchen activities, directs kitchen staff training and work tasks, assesses food costs, food availability, popularity, labour costs, plans menus, creates recipes. Sets safety standards, responsible for purchasing food and equipment.
Sous-chef or Executive sous-chef	Participates in, supervises and coordinates the preparation of menu items. His or her main responsibility is to make sure that the food is prepared, portioned, garnished and presented according to the standards set by the executive chef.
Line Cooks	Responsible for preparing menu items according to recipe specifications.
Pastry Chef	Responsible for developing recipes for and preparing desserts, pastries, frozen desserts and bread.
Apprentices	Cooks who are learning their trade in different areas of the kitchen.
Short Order Cook	Responsible for quickly preparing foods to order in smaller operations.
Institutional Cook	Generally works with large quantities of prepackaged or prepared foods for institutions such as schools, hospitals, jails.
Camp Cook	Often prepare food in remote locations with limited facilities.

THE CLASSIC KITCHEN VOCABULARY - WORDMATCH

The Entremetier
(sounds like...en-tr-met-tee-ay)

One who is responsible for vegetables, starches and soups.

The patissier
(sounds like...paw-tees-see-ay)

One who is responsible for all baked items including breads, pastries and desserts.

The Saucier
(sounds like...saw-see-ay)

One who is responsible for all sautéed items and most sauces.

The garde-manger
(sounds like...guard-mon-jay)

One who is responsible for buffets and cold preparations as well as butchering meats and poultry.

Sous-chef or Executive sous-chef

Participates in, supervises and coordinates the preparation of menu items. His or her main responsibility is to make sure that the food is prepared, portioned, garnished and presented according to the standards set by the executive chef.

The Executive Chef

Coordinates kitchen activities, directs kitchen staff training and work tasks, assesses food costs, food availability, popularity, labour costs, plans menus, creates recipes. Sets safety standards, responsible for purchasing food and equipment.

Pastry Chef

Responsible for developing recipes for and preparing desserts, pastries, frozen desserts and bread.

Line Cooks

Responsible for preparing menu items according to recipe specifications.

Short Order Cook

Responsible for quickly preparing foods to order in smaller operations.

Camp Cook

Often prepare food in remote locations with limited facilities.

Apprentices

Cooks who are learning their trade in different areas of the kitchen.

Institutional Cook

Generally works with large quantities of prepackaged or prepared foods for institutions such as schools, hospitals, jails.

The Vocabulary of Eating Well

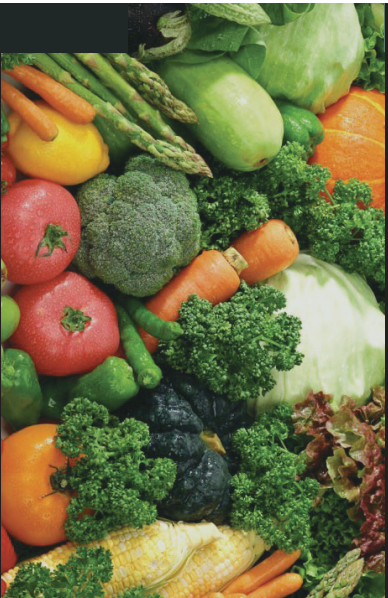

PROFESSIONALISM

Gastronomy
The art and science of eating well.
Gourmet
one who enjoys fine food and drink.
Gourmand
one who enjoys fine food and drink, often to excess.
Gourmet Foods
Foods of the highest quality, perfectly prepared and beautifully presented.

The Vocabulary of Eating Well

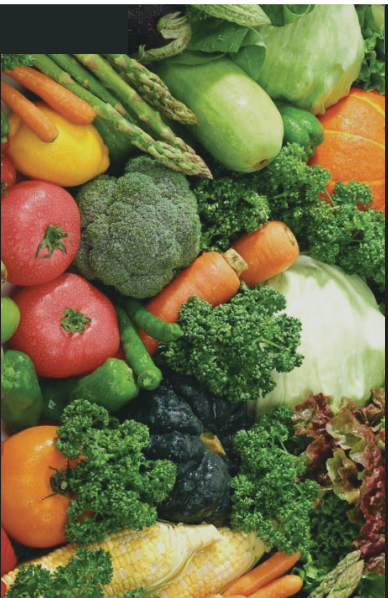

PROFESSIONALISM

Gastronomy
The art and science of eating well.
Gourmet
one who enjoys fine food and drink.
Gourmand
one who enjoys fine food and drink, often to excess.
Gourmet Foods
Foods of the highest quality, perfectly prepared and beautifully presented.

The Vocabulary of Eating Well

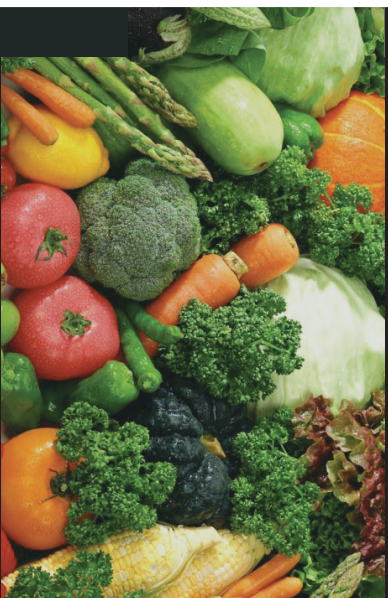

PROFESSIONALISM

Gastronomy
The art and science of eating well.
Gourmet
one who enjoys fine food and drink.
Gourmand
one who enjoys fine food and drink, often to excess.
Gourmet Foods
Foods of the highest quality, perfectly prepared and beautifully presented.



LESSON PLAN - ON TASTE - FILL IN THE BLANKS

From the kitchen of **PROFESSIONALISM**

Purpose and Practice:

- Reading material previously studied in class
- Remembering what was learned

Ingredients

Page 41
(learners' handout)

Page 42
(instructor's
answer key)

Method

- Instructor prepares appropriate number of "On Taste" handouts for the learners
- Individually, learners fill in the banks using the words provided to complete the passage.
- Instructor reviews the answers with the class in a group setting

Invite learners to discuss the topic of "taste" and what this means to them. (i.e. "describe a time when you tasted something new for the first time", "what is your favourite flavour of ice cream", "do you prefer sweet or salty")

Cooking Time

20 minutes

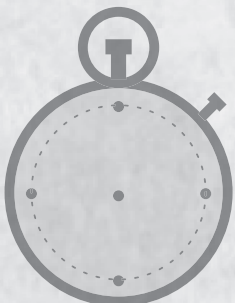

Essential Skills being practiced

- ✓ Reading Text
- ✓ Thinking Skills
- ✓ Writing
- ✓ Document Use

Tip:

(to practice oral communication skills)

ON TASTE

Fill in the blanks using the words provided below:

sweet**babyfood****four****aromatic****umami****early****hot****salty****astringent**

The structure of our taste is formed very _____, basically when we start eating _____ . As Westerners, we divide taste into _____ major groups: _____, sour, _____ and bitter.

Other cultures have added _____ (a pleasant savoury taste), _____ (spicy), _____ (a dry feeling in the mouth), _____ and pungent to the modern definition of taste.

ON TASTE - ANSWERS

Fill in the blanks using the words provided below:

sweet

babyfood

four

aromatic

umami

early

hot

salty

astringent

The structure of our taste is formed very early, basically when we start eating babyfood. As Westerners, we divide taste into four major groups: sweet, sour, salty and bitter.

Other cultures have added umami (a pleasant savoury taste), hot (spicy), astringent (a dry feeling in the mouth), aromatic and pungent to the modern definition of taste.



**LESSON PLAN - PRIDE IN THE UNIFORM -
FILL IN THE BLANKS**

From the kitchen of **PROFESSIONALISM**

■ Purpose and Practice:

- Reading material previously studied in class and remembering what was learned

■ Ingredients

Page 30
(learners' handout)

Page 31
(instructor's
answer key)

■ Method

- Instructor prepares appropriate number of "Pride in the Uniform" handouts for the learners
- Individually, learners fill in the banks using the words provided to complete the passage.
- Instructor reviews the answers with the class in a group setting

■ Cooking Time

30 minutes

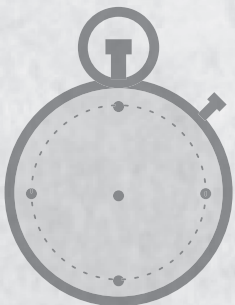

■ Essential Skills being practiced

- ✓ Reading Text
- ✓ Thinking Skills
- ✓ Writing
- ✓ Document Us

Tip:

(for oral communication) Invite learners to discuss the topic of "Uniforms" and what this means to them. (i.e. "What are the benefits to wearing a uniform at work?", "What does wearing a uniform in the kitchen mean to you?")

PRIDE IN THE UNIFORM

Fill in the blanks using the words provided below:

pressed
stains
rebuttoned

burns
pride
uniform

absorbs
polished
protects



Checked trousers disguise _____. The double-breasted white jacket can be _____ to hide dirt, and the double layer fabric _____ from scalds and _____. The neckerchief _____ facial perspiration and the apron protects the _____ and insulates the body. Side towels are useful. This uniform should be worn with _____. Shoes should be _____; trousers and jacket should be _____.

PRIDE IN THE UNIFORM - ANSWERS

Fill in the blanks using the words provided below:

pressed
stains
rebuttoned

burns
pride
uniform

absorbs
polished
protects



Checked trousers disguise stains. The double-breasted white jacket can be rebuttoned to hide dirt, and the double layer fabric protects from scalds and burns. The neckerchief absorbs facial perspiration and the apron protects the uniform and insulates the body. Side towels are useful. This uniform should be worn with pride. Shoes should be polished; trousers and jacket should be pressed.



FOOD SAFETY & SANITATION



**LESSON PLAN - TERMS AND DEFINITIONS -
WORD/DEFINITION MATCH**

From the kitchen of **FOOD SAFETY & SANITATION**

■ Purpose and Practice:

- Matching food safety and sanitation related vocabulary to definitions
- Studying and memorizing pertinent terms

■ Ingredients

Page 47, 48
(handout – Terms
and Definitions:
series 1, 2 and 3)

Pages 49, 50, 51,
52, 53, 54
(vocabulary/
definition cut
outs – 8 terms per
series)

■ Method

- Instructor prepares appropriate number of sets of the 24 terms by photocopying the 24 terms (shaped like squares, octagons, circles and triangles) and cutting them out along the dotted lines so that the outside of the shape (the term) and the inside of the shape (the definition) are separated from each other.
- Separate the terms by series
- Shuffle word and definitions from series 1 so that they are not in order
- Distribute a complete (shuffled) set to each group (2 to 5 students per group)
- Invite each group to work together (encouraging total participation) to match the correct term to the correct definition of the term.
- Come together as a whole class to review matches and practice pronunciation together.
- Provide each learner with a copy of the handout called “Terms and Definition” Series 1, 2, 3

■ Cooking Time

30-45
minutes per series

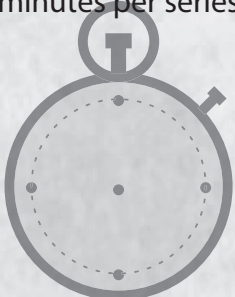

■ Essential Skills being practiced

- ✓ Thinking Skills
- ✓ Working With Others
- ✓ Oral Communication
- ✓ Document Use
- ✓ Reading Text

Tip:

Deliver just one series per session. The terms are complicated and should be practiced in small doses with some reflection time before studying a new set. To avoid mixing up sets, come up with a system of tagging sets for easy re-set and shuffle. For example, each set of series 1 can be labelled 1 in a particular color, series 2 labelled 2 in a particular color and series 3 in a particular color.

TERMS AND DEFINITIONS

SERIES 1

Vocabulary	Description
sanitation	the creation and maintenance of conditions that control food contamination of food borne illnesses
contamination	the presence of harmful organisms or substances
direct contamination	the contamination of raw foods in their natural settings or habitats
cross contamination	the transfer of bacteria or other contaminants from one food, work surface or piece of equipment to another
microorganisms	single-celled organisms as well as tiny plants and animals that can be seen only through a microscope
putrefactives	bacteria that spoil food without making it unfit for eating
pathogen	any organism that causes illness; usually refers to bacteria
intoxication	in the food safety language, an illness caused by the toxins that bacteria produce

SERIES 2

toxins	byproducts of living bacteria that can cause illness if you eat enough
infection	in the food safety context, an illness caused by the ingestion of live pathogenic bacteria that multiply in the consumer's intestinal tract
toxin mediated infection	illness from toxins produced in the intestine after ingesting living bacteria
potentially hazardous foods	foods on which bacteria survive and multiply
temperature danger zone	the range of temperatures between 4 degrees Celsius and 60 degrees Celsius (40 degrees Fahrenheit and 140 degrees Fahrenheit) at which bacteria multiply rapidly
lag phase	a period, usually following transfer from one place to another, during which bacteria do not experience much growth
log phase	a period of accelerated growth for bacteria
decline phase	a period during which bacteria die at an accelerated rate, also known as the negative growth phase

TERMS AND DEFINITIONS - continued

SERIES 3

Vocabulary	Description
anaerobic bacteria	bacteria that is able to live and grow without the presence of oxygen
facultative bacteria	bacteria that can adapt and will survive with or without oxygen
aerobic bacteria	bacteria that needs oxygen to survive
trichinosis	an illness caused by eating undercooked game or pork infected with trichina larvae
anisakiasis	an illness caused by parasitic roundworms
cyclospora	caused by a single-celled parasite found in water or food contaminated by infected feces
hepatitis A	this virus often enters the food supply through sewage-polluted waters. It is carried by humans and transmitted by poor personal hygiene and cross contamination
Norwalk virus	this virus is spread almost entirely by poor personal hygiene among infected food handlers. The virus is found in human feces, contaminated water or vegetables fertilized by manure

TERMS AND DEFINITIONS - WORDMATCH

SERIES 1

A square graphic with a blue border. The word "sanitation" is written in bold black text on the top, bottom, left, and right sides of the border. Inside the square, the following text is centered: "the creation and maintenance of conditions that control food contamination of food borne illnesses".

An octagonal graphic with a red border. The word "contamination" is written in bold black text on the top, bottom, left, and right sides of the border. Inside the octagon, the following text is centered: "the presence of harmful organisms or substances".

A triangular graphic with a yellow border. The words "direct contamination" are written in bold black text on the top-left, top-right, and bottom sides of the border. Inside the triangle, the following text is centered: "the contamination of raw foods in their natural settings or habitats".

A circular graphic with a green border. The words "cross contamination" are written in bold black text on the top and bottom sides of the border. Inside the circle, the following text is centered: "the transfer of bacteria or other contaminants from one food, work surface or piece of equipment to another".

TERMS AND DEFINITIONS - WORDMATCH

SERIES 1



microorganisms

single-celled organisms as well as tiny plants and animals that can be seen only through a microscope

microorganisms

microorganisms

microorganisms

microorganisms

microorganisms



putrefactives

bacteria that spoil food without making it unfit for eating

putrefactives

putrefactives

putrefactives

putrefactives

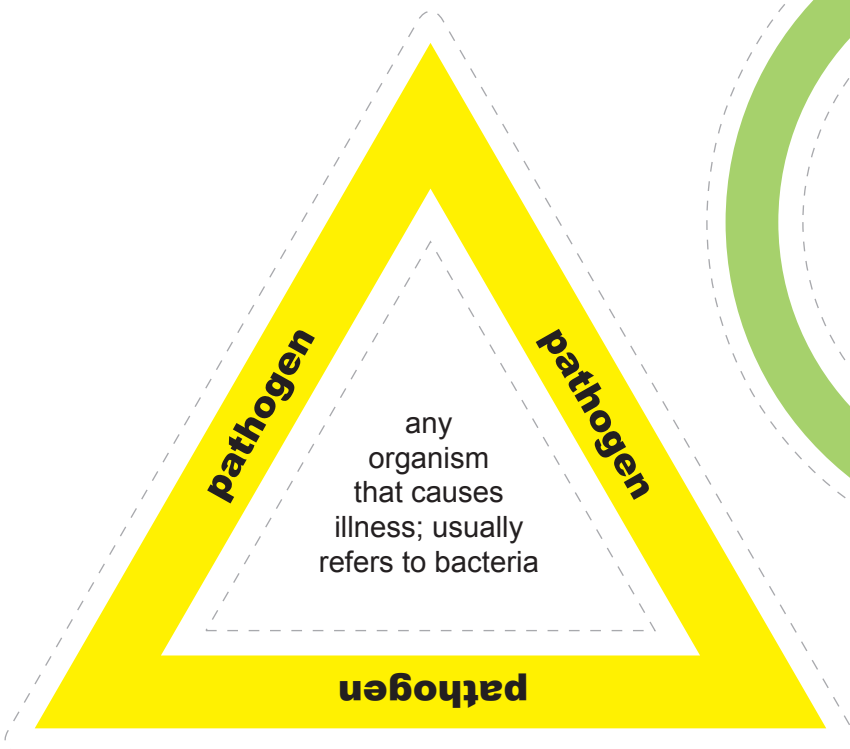

pathogen

any organism that causes illness; usually refers to bacteria

pathogen

pathogen

pathogen



intoxication

in the food safety language, an illness caused by the toxins that bacteria produce

intoxication

Terms and Definitions - Wordmatch

SERIES 2

toxins

toxins

toxins

toxins

byproducts of living bacteria that can cause illness if you eat enough

infection

infection

infection

infection

in the food safety context, an illness caused by the ingestion of live pathogenic bacteria that multiply in the consumer's intestinal tract

toxin mediated infection

toxin mediated infection

toxin mediated infection

illness from toxins produced in the intestine after ingesting living bacteria

potentially hazardous foods

potentially hazardous foods

foods on which bacteria survive and multiply

Terms and Definitions - Wordmatch

SERIES 2

temperature danger zone

temperature danger zone

temperature danger zone

temperature danger zone

the range of temperatures between 4 degrees Celsius and 60 degrees Celsius (40 degrees Fahrenheit and 140 degrees Fahrenheit) at which bacteria multiply rapidly

lag phase

lag phase

lag phase

lag phase

a period, usually following transfer from one place to another, during which bacteria do not experience much growth

log phase

log phase

log phase

log phase

a period of accelerated growth for bacteria

decline phase

decline phase

decline phase

a period during which bacteria die at an accelerated rate, also known as the negative growth phase

Terms and Definitions - Wordmatch

SERIES 3

anaerobic bacteria

anaerobic bacteria

anaerobic bacteria

anaerobic bacteria

bacteria that is able to live and grow without the presence of oxygen

trichinosis

trichinosis

trichinosis

trichinosis

an illness caused by eating undercooked game or pork infected with trichina larvae

aerobic bacteria

aerobic bacteria

aerobic bacteria

bacteria that needs oxygen to survive

facultative bacteria

facultative bacteria

facultative bacteria

facultative bacteria

bacteria that can adapt and will survive with or without oxygen

Terms and Definitions - Wordmatch

SERIES 3

cyclospora

cyclospora

cyclospora

cyclospora

caused by a single-celled parasite found in water or food contaminated by infected feces

hepatitis A

hepatitis A

hepatitis A

hepatitis A

this virus often enters the food supply through sewage-polluted waters. It is carried by humans and transmitted by poor personal hygiene and cross contamination

anisakiasis

anisakiasis

anisakiasis

an illness caused by parasitic roundworms

Norwalk virus

Norwalk virus

this virus is spread almost entirely by poor personal hygiene among infected food handlers. The virus is found in human feces, contaminated water or vegetables fertilized by manure



LESSON PLAN - ACRONYMS - WORD/DEFINITION MATCH

From the kitchen of **FOOD SAFETY & SANITATION**

■ Purpose and Practice:

- Review of pertinent acronyms related to food safety in the food industry.
- Identification of acronyms, what they stand for and what they mean

■ Ingredients

Page 56 (handout definition and description)
 Page 57 (meaning and definition cut outs)
 Page 58 (practice acronym, meaning and definition)
 Page 59 (Quiz)
 Page 60 (Answer key for the quiz)

■ Method

- Instructor prepares appropriate number of sets of the 9 terms using page 57, by cutting out along the dotted lines to separate the acronym from the meaning and the definition.
- Shuffle acronyms, meanings and definitions so that they are not in order
- Distribute a complete (shuffled) set to each group (2 to 5 students per group)
- Invite each group to work together (encouraging total participation) to match the acronym to the correct meaning and definition.
- Come together as a whole class to review matches.
- Provide each learner with a copy of the handout called "Acronyms"
- Using page 58 as a handout, invite the students to practice writing out the acronyms, what they stand for and their meaning
- Have the learners complete the quiz on page 59. Review the answers together.

■ Cooking Time

60 minutes



■ Essential Skills being practiced

- ✓ Thinking Skills
- ✓ Working With Others
- ✓ Document Use
- ✓ Reading Text
- ✓ Writing

Tip:

Tag sets by color for easy re-set and shuffle for future use.

Invite the students to talk about other acronyms used in daily life. Discuss the benefits and challenges to using acronyms at work.

ACRONYMS

Acronym	Definition	Description
CFIA	Canadian Food Inspection Agency	ultimate responsibility in Food Industry
PHF	Potentially Hazardous Food	foods on which bacteria can thrive
pH	potential Hydrogen	to do with acid/alkaline balance
°C	degrees Celsius	Metric system for measuring temperature
°F	degrees Fahrenheit	Imperial system for measuring temperature
HACCP	Hazard Analysis Critical Control Points	a modern, scientifically based inspection system
SAFE	Sanitary Assessment of the Food Environment	a rigorous self inspection system
OHSA	Occupational Health and Safety Act	legislation enacted by the Federal Government with a goal to reduce hazards in the work area
CPR	cardiopulmonary resuscitation	a first aid procedure for reviving the lungs

ACRONYMS - WORDMATCH

CFIA	Canadian Food Inspection Agency	ultimate responsibility in Food Industry
PHF	Potentially Hazardous Food	foods on which bacteria can thrive
pH	potential Hydrogen	to do with acid/alkaline balance
°C	degrees Celsius	metric system for measuring temperature
°F	degrees Fahrenheit	imperial system for measuring temperature
HACCP	Hazard Analysis Critical Control Points	a modern, scientifically based inspection system
SAFE	Sanitary Assessment of the Food Environment	a rigorous self inspection system
OHSA	Occupational Health and Safety Act	legislation enacted by the Federal Government with a goal to reduce hazards in the work area
CPR	cardiopulmonary resuscitation	a first aid procedure for reviving the lungs

ACRONYMS - PRACTICE SHEET

Acronym	Definition	Description

ACRONYMS - QUIZ

Acronym	Definition
	Canadian Food Inspection Agency
PHF	
	potential Hydrogen
°C	
	Imperial system for measuring temperature
	Hazard Analysis Critical Control Points
	Sanitary Assessment of the Food Environment
OHSA	
	cardiopulmonary resuscitation

ACRONYMS - ANSWERS

Acronym	Definition
CFIA	Canadian Food Inspection Agency
PHF	Potentially Hazardous Food
pH	potential Hydrogen
°C	Metric system for measuring temperature
°F	Imperial system for measuring temperature
HACCP	Hazard Analysis Critical Control Points
SAFE	Sanitary Assessment of the Food Environment
OHSA	Occupational Health and Safety Act
CPR	cardiopulmonary resuscitation



LESSON PLAN - DISH AND EQUIPMENT CLEANLINESS

From the kitchen of **FOOD SAFETY & SANITATION**

■ Purpose and Practice:

- Review 6 dishwashing steps in a commercial kitchen
- Practice working in a team sorting the steps in order

■ Ingredients

Page 62
(handout – Dish and Equipment Cleanliness – 6steps)

Page 63
(6 steps cut-outs color coded to make 5 sets)

■ Method

- Instructor prepares appropriate number of sets of the 6 steps by cutting out along the dotted lines.
- Shuffle each set so that the 6 steps are not in order
- Distribute a complete (shuffled) set to each group (2 to 5 students per group)
- Invite each group to work together (encouraging total participation) to sort the 6 steps in order.
- Come together as a whole class to review the sort.
- Provide each learner with a copy of the handout called “Dish and Equipment Cleanliness”

■ Cooking Time

30 minutes

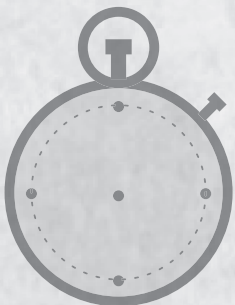

■ Essential Skills being practiced

- ✓ Thinking Skills
- ✓ Working With Others
- ✓ Document Use
- ✓ Reading Text
- ✓ Oral Communication

Tip:

Ask the learners to describe any experience that they may have had in the past washing dishes in a commercial kitchen. How do these steps compare with their own experiences.

DISH AND EQUIPMENT CLEANLINESS - STUDY SHEET



- 1 Dishwasher soaks cutlery and scrapes and rinses dishes
- 2 Dishwasher loads dishes and cutlery on dishwashing machine racks so that spray of water will reach all surfaces of each item.

Machine cleans items with a detergent in wash water

3

Machine sanitizes items with hot water rinse

4



- 5 Items are inspected after machine cycle is complete
- 6 Items are allowed to air dry then stored in a clean area

Essential Skills used:
Thinking Skills, Working with Others, Document Use (lists)

DISH AND EQUIPMENT CLEANLINESS - EXERCISE

Dishwasher soaks cutlery and scrapes and rinses dishes

Dishwasher loads dishes and cutlery on dishwashing machine racks so that spray of water will reach all surfaces of each item.

Machine cleans items with a detergent in wash water

Machine sanitizes items with hot water rinse

Items are inspected after machine cycle is complete

Items are allowed to air dry then stored in a clean area



LESSON PLAN - TEMPERATURE DANGER ZONE - POCKET GUIDE AND POSTER

From the kitchen of **FOOD SAFETY & SANITATION**

■ Purpose and Practice:

- Review the importance of understanding the "Temperature Danger Zone"
- Provide the students with their own pocket guide to the Temperature Danger Zone
- Reinforce the saying: "Keep hot foods hot and cold foods cold"

■ Ingredients

Page 65
(handout – pocket guide)

Page 66
(small poster)

Page 67
(large 11 x 17 poster)

■ Method

- Instructor prepares appropriate number of pocket guides and reviews the information
- Instructor prints 8 1/2 x 11 poster sizes and posts them strategically in the learning and industrial kitchen.
- Instructor prints 11 x 17 poster sizes and posts them strategically in the learning and industrial kitchen.

■ Cooking Time

15 minutes



■ Essential Skills being practiced

- ✓ Document Use
- ✓ Thinking Skills

Tip:

Laminate the pocket guides for durability. Invite the students to use them as bookmarks.

Temperature Danger Zone

Food Safety & Sanitation

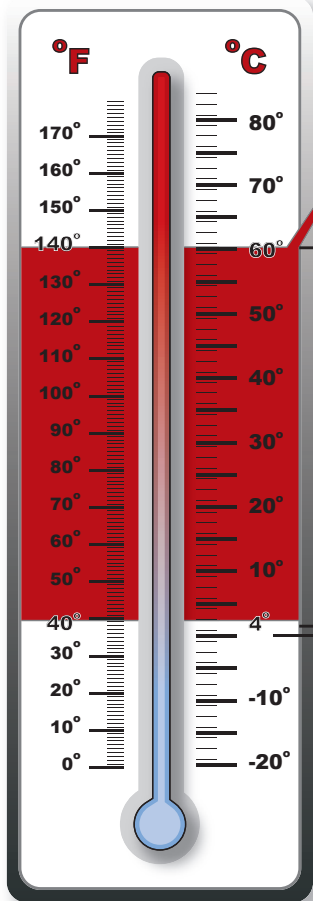

The temperature danger zone is:

The broad range of temperatures at which bacteria multiply rapidly

Between **4° Celsius** and **60° Celsius** or

40° Fahrenheit and **140° Fahrenheit**

0° Freezer Temperature

°F	= Fahrenheit
°C	= Celsius

Temperature Danger Zone

Food Safety & Sanitation

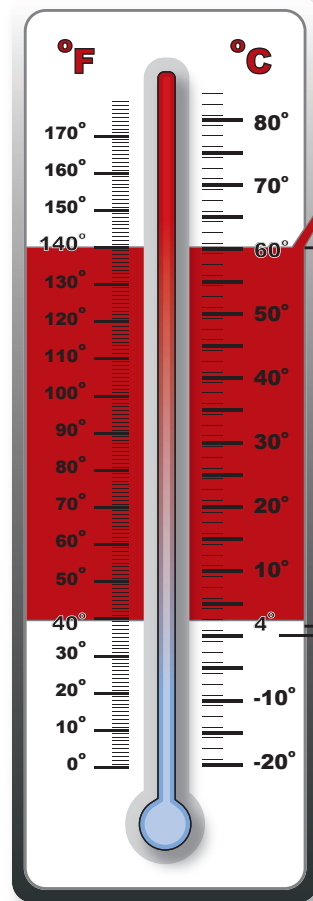

The temperature danger zone is:

The broad range of temperatures at which bacteria multiply rapidly

Between **4° Celsius** and **60° Celsius** or

40° Fahrenheit and **140° Fahrenheit**

0° Freezer Temperature

°F	= Fahrenheit
°C	= Celsius

Temperature Danger Zone

Food Safety & Sanitation

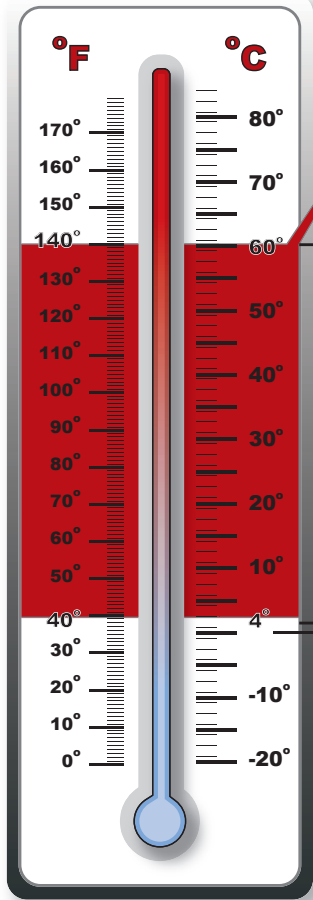

The temperature danger zone is:

The broad range of temperatures at which bacteria multiply rapidly

Between **4° Celsius** and **60° Celsius** or

40° Fahrenheit and **140° Fahrenheit**

0° Freezer Temperature

°F	= Fahrenheit
°C	= Celsius

Temperature Danger Zone

Food Safety & Sanitation

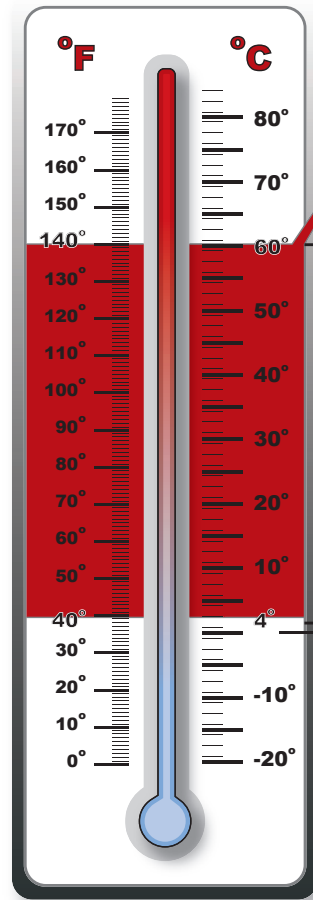

The temperature danger zone is:

The broad range of temperatures at which bacteria multiply rapidly

Between **4° Celsius** and **60° Celsius** or

40° Fahrenheit and **140° Fahrenheit**

0° Freezer Temperature

°F	= Fahrenheit
°C	= Celsius

Temperature Danger Zone

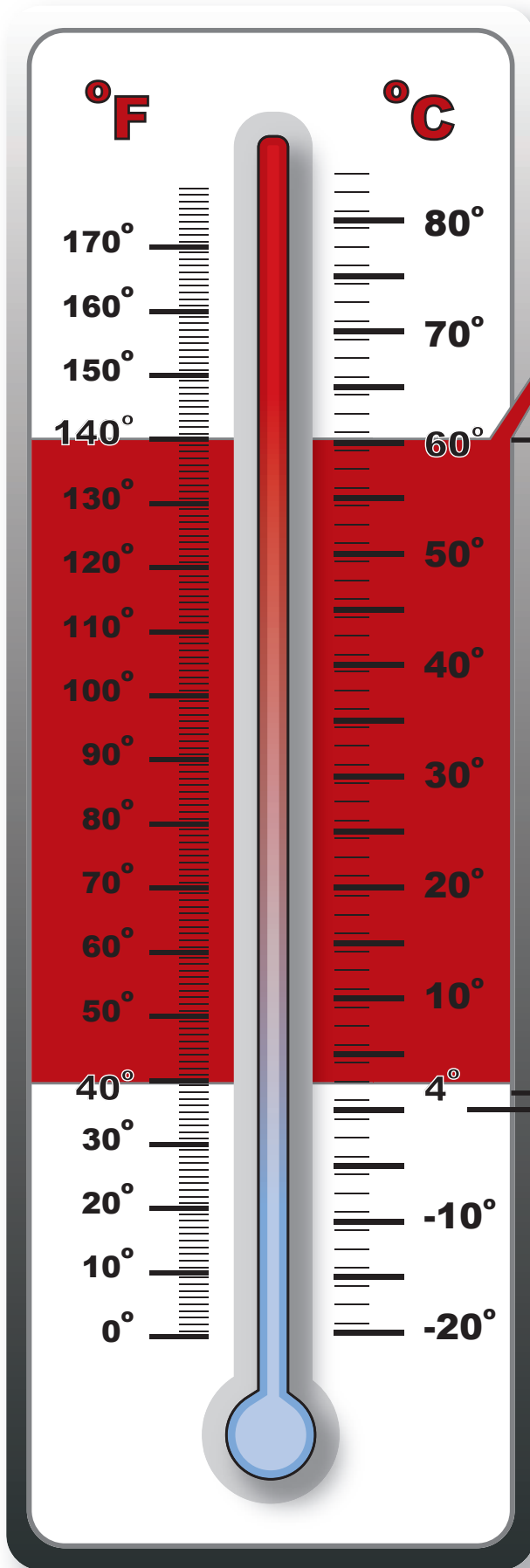

The temperature danger zone is:

- The broad range of temperatures at which bacteria multiply rapidly
- Between **4° Celsius** and **60° Celsius** or **40° Fahrenheit** and **140° Fahrenheit**
- **0° Freezer Temperature**

LEGEND	°F = Fahrenheit
	°C = Celsius

TEMPERATURE DANGER ZONE - 11 X 17 POSTER

This poster can be found at pg. 510

Essential Skills Companion Kit for Culinary Arts Trades Training

Temperature Danger Zone

Food Safety & Sanitation

The temperature danger zone is:

- The broad range of temperatures at which bacteria multiply rapidly
- Between **4° Celsius** and **60° Celsius** or **40° Fahrenheit** and **140° Fahrenheit**
- 0° Freezer Temperature**

LEGEND

- °F** = Fahrenheit
- °C** = Celsius

**LESSON PLAN - PROPER HAND WASHING PROCEDURES -
POCKET GUIDE AND POSTER**



From the kitchen of **FOOD SAFETY & SANITATION**

■ Purpose and Practice:

- Review the importance of practicing “Safe Hand Washing Procedures”
- Provide the students with their own pocket guide to “Safe Hand Washing Procedures”

■ Ingredients

Page 69
(handout – pocket
guide)

Page 70
(small poster)

Page 71
(large 11 x 17 poster)

■ Method

- Instructor prepares appropriate number of pocket guides and reviews the information
- Instructor prints 8 1/2 x 11 poster sizes and posts them strategically in the learning and industrial kitchen.
- Instructor prints 11 x 17 poster sizes and posts them strategically in the learning and industrial kitchen.

■ Cooking Time

15 minutes

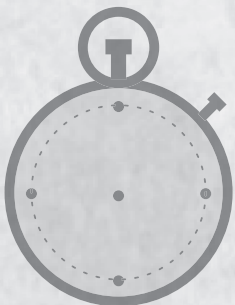

■ Essential Skills being practiced

- ✓ Document Use
- ✓ Thinking Skills

Tip:

Laminate the pocket guides for durability. Invite the students to use them as bookmarks.

Proper Hand Washing Procedures



1 Use hot running water
Wet hands and forearms

2 Apply soap
Rub hands and arms briskly with soapy
lather for at least 20 seconds



3 Scrub between fingers and clean nails
with a clean nail brush

4 Rinse thoroughly under hot running
water



5 Reapply soap and scrub hands and
forearms for another 5 to 10 seconds

6 Rinse again



7 Dry hands and arms using a
single-use towel

8 Use the towel to turn off the water
Discard the towel in a trash bin



Food Safety & Sanitation

Proper Hand Washing Procedures



1 Use hot running water
Wet hands and forearms

2 Apply soap
Rub hands and arms briskly with soapy
lather for at least 20 seconds



3 Scrub between fingers and clean nails
with a clean nail brush

4 Rinse thoroughly under hot running
water



5 Reapply soap and scrub hands and
forearms for another 5 to 10 seconds

6 Rinse again



7 Dry hands and arms using a
single-use towel

8 Use the towel to turn off the water
Discard the towel in a trash bin

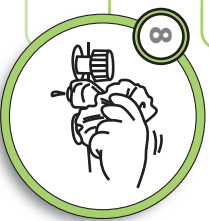

Food Safety & Sanitation

Proper Hand Washing Procedures



1

**Use hot running water
Wet hands and forearms**

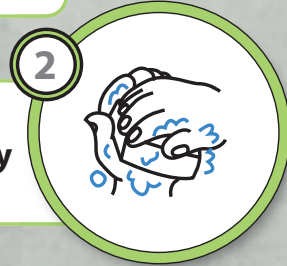

2

**Apply soap
Rub hands and arms briskly with soapy
lather for at least 20 seconds**



3

**Scrub between fingers and clean
nails with a clean nail brush**



4

**Rinse thoroughly under hot running
water**

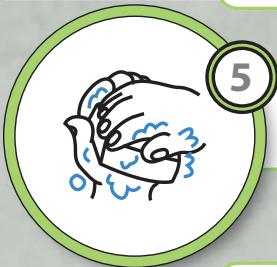

5

**Reapply soap and scrub hands and
forearms for another 5 to 10 seconds**



6

Rinse again

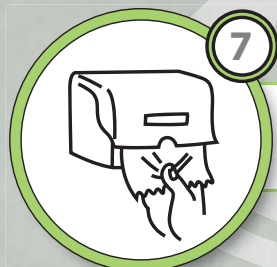

7

**Dry hands and arms using a
single-use towel**



8

**Use the towel to turn off the water
Discard the towel in a trash bin**

PROPER HAND WASHING PROCEDURES - 11 X 17 POSTER

This poster can be found at pg. 510

Essential Skills Companion Kit for Culinary Arts Trades Training

Proper Hand Washing Procedures

Food Safety & Sanitation



1

Use hot running water
Wet hands and forearms



2

Apply soap
Rub hands and arms briskly with soapy
lather for at least 20 seconds



3

Scrub between fingers and clean nails
with a clean nail brush



4

Rinse thoroughly under hot running
water



5

Reapply soap and scrub hands and
forearms for another 5 to 10 seconds



6

Rinse again

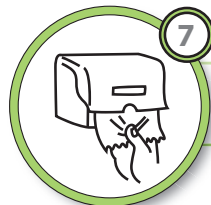

7

Dry hands and arms using a
single-use towel



8

Use the towel to turn off the water
Discard the towel in a trash bin



**LESSON PLAN - SAFE BEHAVIOR ON THE JOB -
FILL IN THE BLANKS**

From the kitchen of **FOOD SAFETY & SANITATION**

■ Purpose and Practice:

- Review the importance of understanding safe behaviour on the job
- Students will navigate through a poster and fill in the blanks
- Reinforce the importance of safety on the job and how to avoid accidents

■ Ingredients

Page 73
(poster 8 ½ x 11)
Page 74
(student handout –
fill in the blanks)
Page 75
(instructor answer
key)
Page 76
(large 11 x 17 poster)

■ Method

- Instructor provides each student with and 8 ½ x 11 poster of “Safe Behaviour on the Job” and reviews the information with the class
- Students use their handout to fill in the blanks using their poster
- Instructor prints 11 x 17 poster sizes and posts them strategically in the learning and industrial kitchen.

■ Cooking Time

30 - 40 minutes

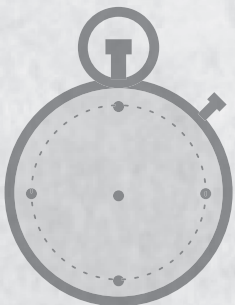

■ Essential Skills being practiced

- ✓ Document Use
- ✓ Thinking Skills
- ✓ Writing
- ✓ Oral Communication

Tip:

Encourage discussion around safe practices on the job.... “think about the last job you had.... What kinds of safety measures were in place”

SAFE BEHAVIOUR ON THE JOB

SAFETY
IS YOUR RESPONSIBILITY

THIS KITCHEN HAS WORKED

DAYS

WITHOUT A **LOST TIME INJURY**

THE BEST PREVIOUS RECORD WAS

DAYS

DO YOUR PART TO BETTER THE RECORD

SAFETY FIRST

CLEAN UP



SPILLS

Clean up spills as soon as they occur

Learn to operate equipment properly; always use guards and safety devices

WARNING



Do not use unless guards are in position

DO NOT WEAR JEWELRY OR LOOSE CLOTHING WHEN OPERATING



Wear clothing that fits properly; avoid wearing jewelry, which may get caught in equipment

BE CAREFUL



WALK! DON'T RUN

Walk, do not run

Keep exits, aisles and stairs clear and unobstructed

Use knives and other equipment for their intended purpose only

SAFETY FIRST

WORK CAREFULLY WITH KNIVES

PLEASE

KEEP ALL AISLES CLEAN AND CLEAR OF OBSTRUCTIONS

CAUTION



HOT!

Always assume a pot or pan is hot; handle with dry towels

Position pot and pan handles out of the aisles so they do not get bumped

Get help or use a cart when lifting or moving heavy objects

Avoid back injury by lifting with your leg muscles; stoop, do not bend, when lifting

HOW TO LIFT CORRECTLY

THE RIGHT WAY



LEGS BENT, BACK KEPT AS STRAIGHT AS POSSIBLE, LOAD CLOSE TO BODY, GRIPPED AT OPPOSITE CORNERS

THE WRONG WAY



LEGS STRAIGHT, BACK BENT, PUTS ALL THE STRAIN ON THE MUSCLES OF THE BACK & ABDOMEN

LADDER RULES



- ALWAYS FACE LADDER WHEN ASCENDING OR DESCENDING
- USE AT LEAST ONE HAND TO GRASP LADDER
- TOP OF LADDER SHOULD NEVER BE USED AS A STEP
- LADDERS SHOULD NEVER BE MOVED, SHIFTED, OR EXTENDED WHILE OCCUPIED
- NEVER CARRY AN OBJECT OR LOAD THAT COULD CAUSE YOU TO LOSE YOUR BALANCE

Use a well placed ladder or stool for climbing; do not use a chair, box, drawer or shelf

Keep breakable items away from food storage or production areas

Warn people when you must walk behind them, especially when carrying a hot pan



SAFE BEHAVIOR ON THE JOB - FILL IN THE BLANKS

- Clean up _____ as soon as they occur
- Learn to operate equipment properly; always use _____ and safety devices
- Wear clothing that fits properly; avoid wearing _____, which may get caught in equipment
- Use knives and other equipment for their intended _____ only
- Walk, do not _____
- Keep exits, aisles and _____ clear and unobstructed
- Always assume a pot or pan is _____; handle with dry towels
- Position pot and pan handles out of the aisles so they do not get _____
- Get help or use a _____ when lifting or moving heavy objects
- Avoid back injury by lifting with your _____ muscles; stoop, do not bend, when lifting
- Use a well-placed _____ or stool for climbing; do not use a chair, box, drawer or shelf
- Keep breakable items away from _____ storage or production areas
- Warn people when you must walk behind them, especially when carrying a _____ pan

SAFE BEHAVIOR ON THE JOB - FILL IN THE BLANKS - ANSWERS

- Clean up spills as soon as they occur
- Learn to operate equipment properly; always use guards and safety devices
- Wear clothing that fits properly; avoid wearing jewelery, which may get caught in equipment
- Use knives and other equipment for their intended purpose only
- Walk, do not run
- Keep exits, aisles and stairs clear and unobstructed
- Always assume a pot or pan is hot; handle with dry towels
- Position pot and pan handles out of the aisles so they do not get bumped
- Get help or use a cart when lifting or moving heavy objects
- Avoid back injury by lifting with your leg muscles; stoop, do not bend, when lifting
- Use a well-placed ladder or stool for climbing; do not use a chair, box, drawer or shelf
- Keep breakable items away from food storage or production areas
- Warn people when you must walk behind them, especially when carrying a hot pan

SAFE BEHAVIOUR ON THE JOB - 11 X 17 POSTER

This poster can be found at

Essential Skills Companion Kit for Culinary Arts Trades Training

SAFE BEHAVIOUR ON THE JOB

SAFETY IS YOUR RESPONSIBILITY
 THIS KITCHEN HAS WORKED
DAYS
 WITHOUT A LOST TIME INJURY
 THE BEST PREVIOUS RECORD WAS
DAYS
 DO YOUR PART TO BETTER THE RECORD

Food Safety & Sanitation

- SAFETY FIRST CLEAN UP SPILLS**
 Clean up spills as soon as they occur
- WARNING**
 Do not use unless guards are in position
 Learn to operate equipment properly; always use guards and safety devices
- DO NOT WEAR JEWELRY OR LOOSE CLOTHING WHEN OPERATING**
 Wear clothing that fits properly; avoid wearing jewelry, which may get caught in equipment
- BE CAREFUL WALK! DON'T RUN**
 Walk, do not run
- PLEASE KEEP ALL AISLES CLEAN AND CLEAR OF OBSTRUCTIONS**
 Keep exits, aisles and stairs clear and unobstructed
- SAFETY FIRST WORK CAREFULLY WITH KNIVES**
 Use knives and other equipment for their intended purpose only
- CAUTION HOT!**
 Always assume a pot or pan is hot; handle with dry towels
 Position pot and pan handles out of the aisles so they do not get bumped
- LADDER RULES**
 - ALWAYS FACE LADDER WHEN ASCENDING OR DESCENDING
 - USE AT LEAST ONE HAND TO GRASP LADDER
 - TOP OF LADDER SHOULD NEVER BE USED AS A STEP
 - LADDERS SHOULD NEVER BE MOVED, SHIFTED, OR EXTENDED WHILE OCCUPIED
 - NEVER CARRY AN OBJECT OR LOAD THAT COULD CAUSE YOU TO LOSE YOUR BALANCE
- HOW TO LIFT CORRECTLY**

THE RIGHT WAY LEGS BENT, BACK KEPT AS STRAIGHT AS POSSIBLE, LOAD CLOSE TO BODY, GRIPPED AT OPPOSITE CORNERS	THE WRONG WAY LEGS STRAIGHT, BACK BENT, PUTS ALL THE STRAIN ON THE MUSCLES OF THE BACK & ABDOMEN
---	--
- Get help or use a cart when lifting or moving heavy objects
- Avoid back injury by lifting with your leg muscles; stoop, do not bend, when lifting
- Use a well placed ladder or stool for climbing; do not use a chair, box, drawer or shelf
- Keep breakable items away from food storage or production areas
- Warn people when you must walk behind them, especially when carrying a hot pan
 "I'M BEHIND YOU. WATCH OUT."



LESSON PLAN - SAFETY ALERT - FILL IN THE BLANKS

From the kitchen of **FOOD SAFETY & SANITATION**

Purpose and Practice:

- Reading material previously studied in class and remembering what was learned

Ingredients

Page 78
(learners' handout)

Page 79
(instructor's answer key)

Method

- Instructor prepares appropriate number of "Safety Alert" handouts for the learners
- Individually, learners fill in the banks using the words provided to complete the passage.
- Instructor reviews the answers with the class in a group setting

Cooking Time

10 - 15 minutes

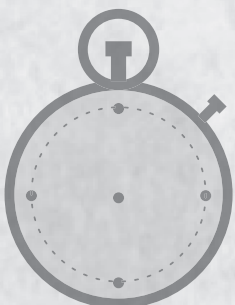

Essential Skills being practiced

- ✓ Reading Text
- ✓ Thinking Skills
- ✓ Writing
- ✓ Document Use

Tip:

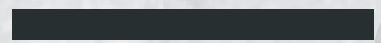

SAFETY ALERT - EXERCISE

When working with or near foods there is always a concern for safety, whether it is physical safety (using knives and hot surfaces), or food safety (hot and cold temperatures). Use the following words to fill in the blanks in the sentences below.

chemicals**originally****cleaners****properly**

1. Never store chemicals in a container that _____ held food;
never store food in a container that once held chemicals.
2. Never store cleaning supplies or other _____ with or
near foods.
3. Keep chemicals and _____ in _____
labelled containers.

SAFETY ALERT - EXERCISE ANSWERS

When working with or near foods there is always a concern for safety, whether it is physical safety (using knives and hot surfaces), or food safety (hot and cold temperatures). Use the following words to fill in the blanks in the sentences below.

chemicals**originally****cleaners****properly**

1. Never store chemicals in a container that originally held food; never store food in a container that once held chemicals.
2. Never store cleaning supplies or other chemicals with or near foods.
3. Keep chemicals and cleaners in properly labelled containers.



TOOLS & EQUIPMENT



LESSON PLAN - STANDARDS FOR TOOLS AND EQUIPMENT

From the kitchen of **TOOLS & EQUIPMENT**

■ Purpose and Practice:

- Review 6 standards for how well-designed tools and equipment benefit the overall efficiency and safety of the operation
- Practice working in a team in order to match up the best possible phrases

■ Ingredients

Page 82
(handout 2 per page) – Standards for Tools and Equipment – 6 standards)
Pages 83
(5 sets color coded) of the 6 standards that have been separated into phrases cut-outs

■ Method

- Instructor makes appropriate number of handouts for the class
- Instructor prepares appropriate number of sets of the 6 standards by cutting out along the dotted lines, separating the sentences into phrases (12 cut outs per set)
- Shuffle each set so that the phrases are not in order
- Distribute a complete (shuffled) set to each group (2 to 5 students per group) Invite each group to work together (encouraging total participation) to match up the phrases
- Come together as a whole class to review the sort.
- Provide each learner with a copy of the handout called “Standards for Tools and Equipment”

■ Cooking Time

30 minutes

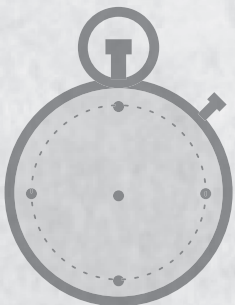

■ Essential Skills being practiced

- ✓ Thinking Skills
- ✓ Working With Others
- ✓ Document Use
- ✓ Reading Text
- ✓ Oral Communication

Tip:

If you notice that a group is struggling with matching up the phrases, tell them that the darker shaded pieces are the beginning of the sentence and the lighter shades pieces form the second part.

Standards for Tools & Equipment

Well-designed tools and equipment benefit the overall efficiency and safety of the operation.

- 1 - Equipment must be easily cleaned.
- 2 - All food contact surfaces must be nontoxic, non-absorbent, corrosion resistant and non-reactive.
- 3 - All food contact surfaces must be smooth, that is, free of pits, cracks, crevices, ledges, rivet heads and bolts.
- 4 - Internal corners and edges must be rounded and smooth; external corners and angles must be smooth and sealed.
- 5 - Coating materials must be nontoxic and easily cleaned; coatings must resist chipping and cracking.
- 6 - Waste and waste liquids must be easily removed.

Standards for Tools & Equipment

Well-designed tools and equipment benefit the overall efficiency and safety of the operation.

- 1 - Equipment must be easily cleaned.
- 2 - All food contact surfaces must be nontoxic, non-absorbent, corrosion resistant and non-reactive.
- 3 - All food contact surfaces must be smooth, that is, free of pits, cracks, crevices, ledges, rivet heads and bolts.
- 4 - Internal corners and edges must be rounded and smooth; external corners and angles must be smooth and sealed.
- 5 - Coating materials must be nontoxic and easily cleaned; coatings must resist chipping and cracking.
- 6 - Waste and waste liquids must be easily removed.

STANDARDS FOR TOOLS AND EQUIPMENT - WORDMATCH

Equipment must be easily

cleaned.

All food contact surfaces must be nontoxic,

non-absorbent, corrosion resistant and non-reactive.

All food contact surfaces must be smooth, that is, free of

pits, cracks, crevices, ledges, rivet heads and bolts.

Internal corners and edges must be rounded and smooth;

external corners and angles must be smooth and sealed.

Coating materials must be nontoxic and easily cleaned;

coatings must resist chipping and cracking.

Waste and waste liquids must be easily

removed.

(cut phrases into strips, shuffle and have learners work in groups of 4 to match up phrases that make sentences. Make 5 sets each one a different color)



**LESSON PLAN - SELECTING TOOLS & EQUIPMENT -
FILL IN THE BLANKS**

From the kitchen of **TOOLS & EQUIPMENT**

■ Purpose and Practice:

- Reading material previously studied in class and remembering what was learned

■ Ingredients

Page 85
(learners' handout)

Page 86
(instructor's answer
key)

■ Method

- Instructor prepares appropriate number of "Selecting Tools and Equipment" handouts for the learners
- Individually, learners fill in the banks using the words provided to complete the passage.
- Instructor reviews the answers with the class in a group setting

■ Cooking Time

10 - 15 minutes

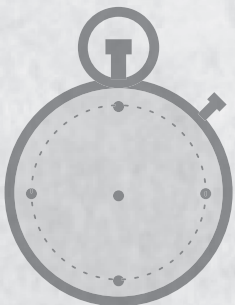

■ Essential Skills being practiced

- ✓ Reading Text
- ✓ Thinking Skills
- ✓ Writing
- ✓ Document Use

Tip:



SELECTING TOOLS AND EQUIPMENT

In general, only commercial food service tools and equipment should be used in a professional kitchen. Household tools and appliances may not withstand the rigours of a professional kitchen.

Look for tools that are well constructed. For example, joints should be welded, not bonded with solder; handles should be comfortable, with rounded borders; plastic and rubber parts should be seamless.

Using the vocabulary words below, please fill in the blanks:

professional

kitchen

appliances

household

tools

In general, only commercial food service _____ and equipment should be used in a _____ kitchen. _____ tools and _____ may not withstand the rigours of a professional _____.

Using the vocabulary words below, please fill in the blanks:

seamless

rounded

welded

constructed

Look for tools that are well _____. For example, joints should be _____, not bonded with solder; handles should be comfortable, with _____ borders; plastic and rubber parts should be _____.

SELECTING TOOLS AND EQUIPMENT - ANSWERS

In general, only commercial food service tools and equipment should be used in a professional kitchen. Household tools and appliances may not withstand the rigours of a professional kitchen.

Look for tools that are well constructed. For example, joints should be welded, not bonded with solder; handles should be comfortable, with rounded borders; plastic and rubber parts should be seamless.

Using the vocabulary words below, please fill in the blanks:

professional

kitchen

appliances

household

tools

In general, only commercial food service tools and equipment should be used in a professional kitchen. household tools and appliances may not withstand the rigours of a professional kitchen.

Using the vocabulary words below, please fill in the blanks:

seamless

rounded

welded

constructed

Look for tools that are well constructed. For example, joints should be welded, not bonded with solder; handles should be comfortable, with rounded borders; plastic and rubber parts should be seamless.



LESSON PLAN - HAND TOOLS - PICTURE/WORD MATCH

From the kitchen of **TOOLS & EQUIPMENT**

Purpose and Practice:

- Review names of tools and what they look like

Ingredients

Page 88
(learners' handout
– pictures of hand
tool names with
space provided to
write in the name
of each tool)

Page 89
Learner and
Instructor Answer
Key

Method

- Instructor prepares copies of "Hand Tools" handouts for the learners (the page with images and blanks to fill in the name of the hand tool)
- Individually, learners fill in the banks with the appropriate hand tool name
- Instructor reviews the answers with the class in a group setting, then provides them with the answer key as a reference.

Cooking Time

10 - 15 minutes

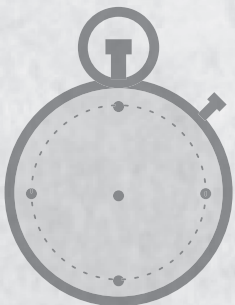

Essential Skills being practiced

- ✓ Reading Text
- ✓ Thinking Skills
- ✓ Writing
- ✓ Document Use

Tip:



HAND TOOLS - EXERCISE

Hand tools are used for many things when in the kitchen. Although knives are considered the most important hand tool in the kitchen, there are many others such as spoons, spatulas, whisks, tongs and specialized cutters. Sturdiness, durability and safety are important words to look for when selecting hand tools. Look at the pictures below and identify the tools that are shown.



HAND TOOLS - ANSWERS

Perforated, Plain and Slotted Spoons



Vegetable Peeler

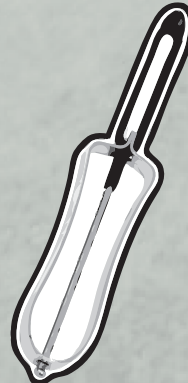

Melon Ball Cutter

(The smaller end is also known as a Parisian Scoop)



Table-Mounted Can Opener

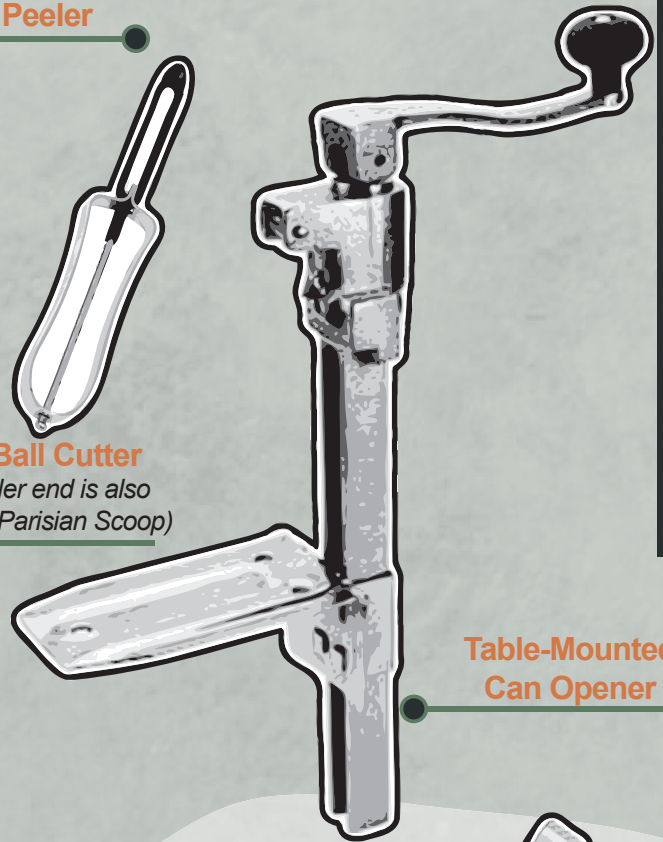

Balloon and French Wisks

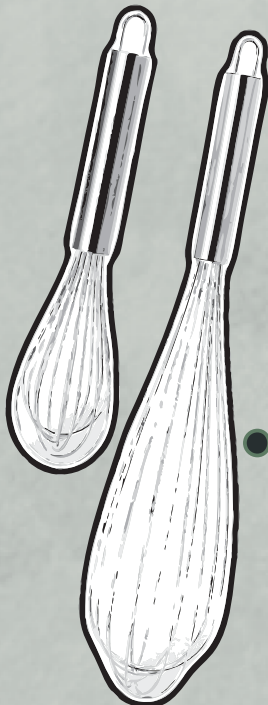

Straight Tongs



Rubber Spatula

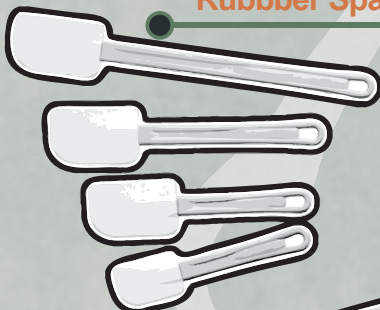

Meat Mallet

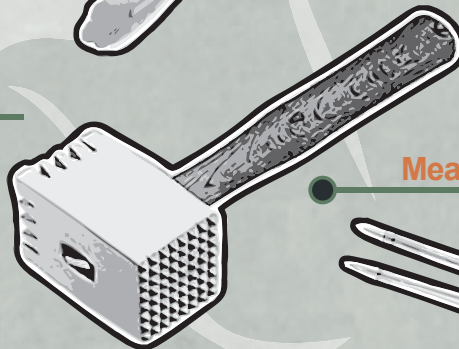

Zester

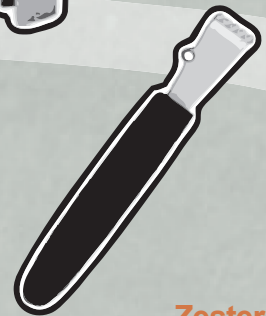

Chef's Fork

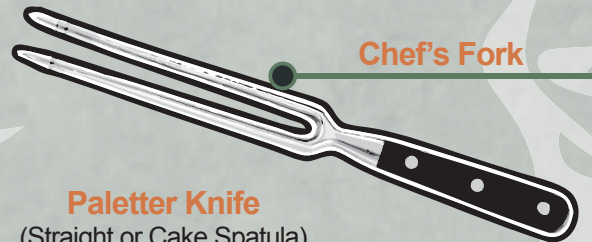

Paletter Knife
(Straight or Cake Spatula)



Grill Spatula



LESSON PLAN - METALS USED FOR KNIVES – THE TANG - PARTS OF A KNIFE – KNIFE NAMES



From the kitchen of **TOOLS & EQUIPMENT**

■ Purpose and Practice:

- Review the types of metals used for knives
- Review of the tang
- Practice naming the parts of a knife as well as knowing knife names

■ Ingredients

Page 91 ,
handout
Page 92,
handout
Page 93,
activity sheet
Page 94,
handout
Page 95,
activity sheet
Page 96
Answer Key

■ Method

- Prepare copies of “Metals Used for Knives” and review with the learners
- Prepare copies of “The Tang-Study Card and Damascus steel knives” and review with the learners
- Have learners complete the “Knife Shapes and Sharpening Equipment Part 1 (Parts of a knife) exercise by identifying the correct parts of a knife using the list of parts provided.
- Review answers with the class
- Prepare copies of “Knife Shapes and Sharpening Equipment Part II – Knife Names and review with the class
- Prepare copies of the Knife Names exercise and have learners write in the correct name of the name according to its definition and picture.
- Review answers by using the answer key

■ Cooking Time

30 - 40 minutes

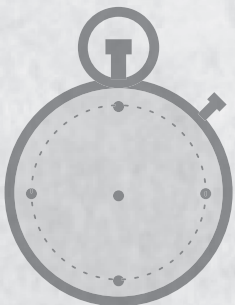

■ Essential Skills being practiced

- ✓ Document Use
- ✓ Reading Text
- ✓ Thinking Skills
- ✓ Writing

Tip:



METALS USED FOR KNIVES

CARBON STEEL

- alloy of carbon and steel
- soft enough for easy sharpening
- corrodes and discolors easily
- not recommended for food service preparation

STAINLESS STEEL

- will not rust, corrode or discolor
- very durable
- harder to sharpen

HIGH CARBON STAINLESS STEEL

- combination of the best features of carbon and stainless steels
- doesn't corrode or discolor
- sharpens easily
- most popular metal for blades

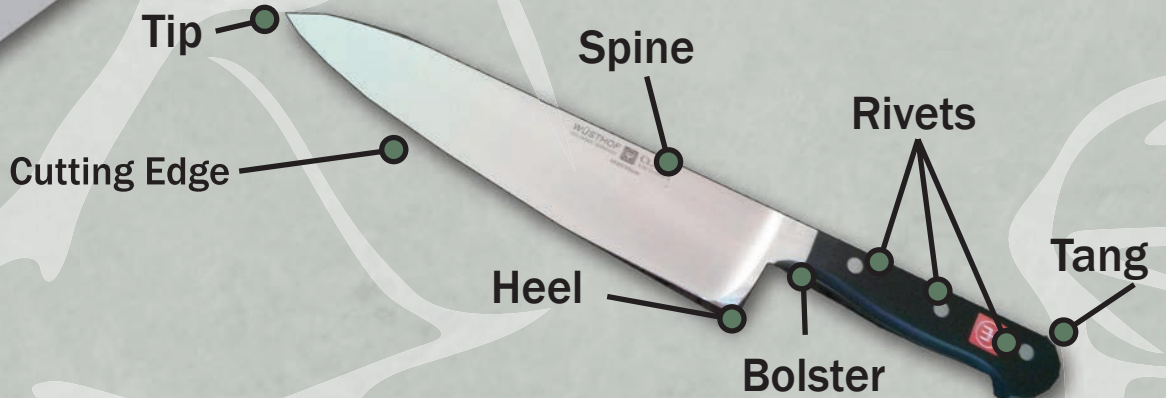

THE TANG

- a portion of the blade that fits inside the handle
- the best knives are made with a full tang running the length of the handle
- they also have a bolster where the blade meets the handle
- cheaper knives may have a $\frac{3}{4}$ length tang or a thin "rattail" tang
- a full tang is best because it provides support, durability and balance

Parts of a Knife

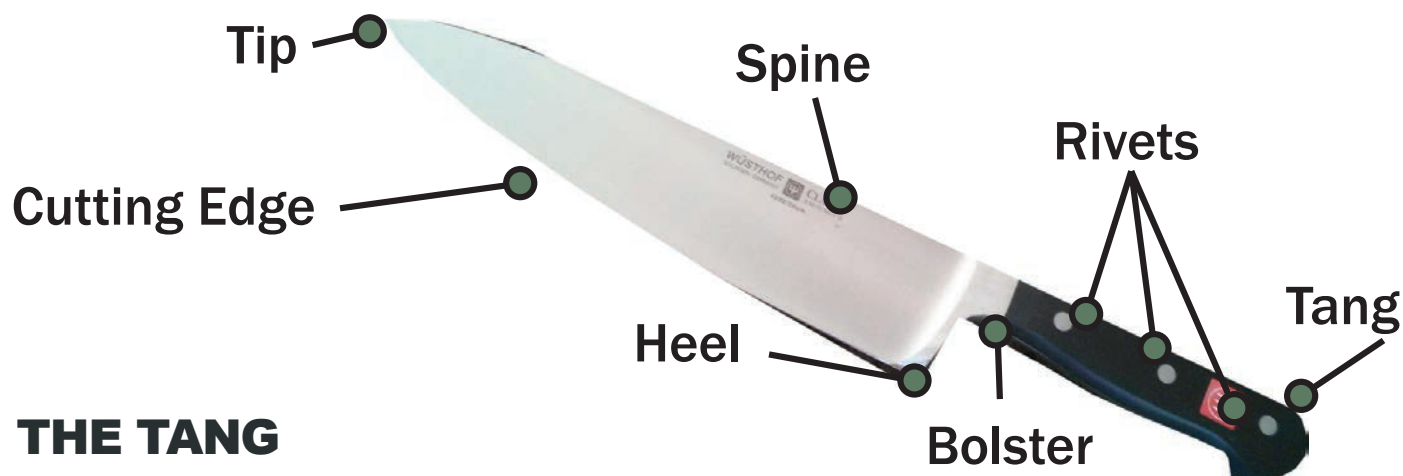

THE TANG

- a portion of the blade that fits inside the handle
- the best knives are made with a full tang running the length of the handle
- they also have a bolster where the blade meets the handle
- cheaper knives may have a $\frac{3}{4}$ length tang or a thin "rattail" tang
- a full tang is best because it provides support, durability and balance

Damascus Steel Knives

Damascus steel was a term used by several Western cultures from the Medieval period onward to describe a type of steel used in Middle Eastern swordmaking from about 1100 to 1700 AD. These swords are characterized by distinctive patterns of banding and mottling reminiscent of flowing water. Such blades were reputed to be not only tough and resistant to shattering, but capable of being honed to a sharp and resilient edge.



PARTS OF A KNIFE - EXERCISE

Use the list below to match the parts of the knife.
Write the name of the part in the appropriate spot.

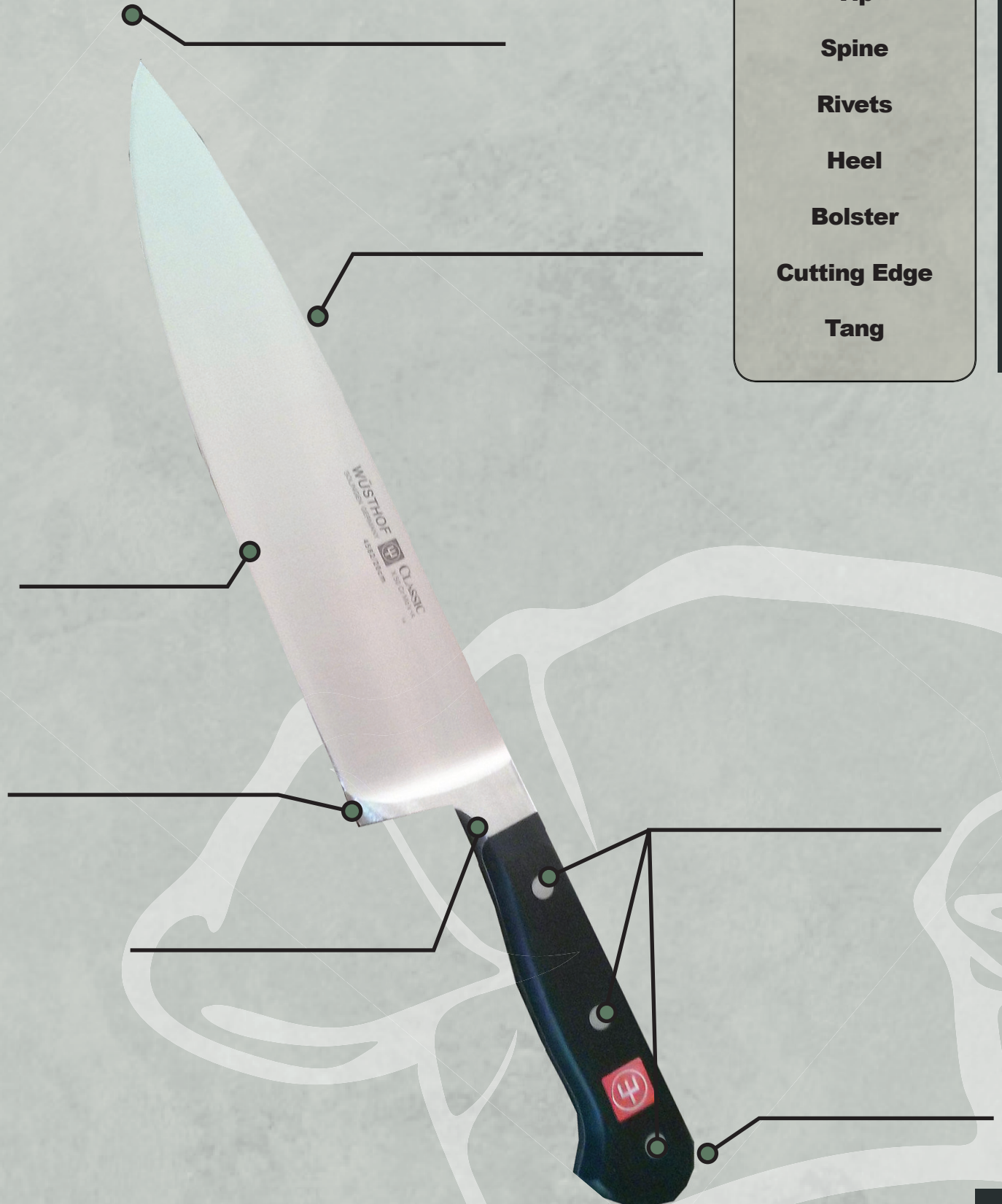

KNIFE NAMES - STUDY SHEET

Knife Shapes and Sharpening Equipment

You may collect many knives during your career and they may all be different, but the one thing that is constant is how it is made. The best knives are constructed from a single piece of metal with a full tang running the length of the handle. This provides support, durability and balance for the user. Handles should be shaped for comfort and ground smooth to eliminate any crevices where bacteria can grow.

French or Chef's Knife

Rigid 20-to 35-cm long blade is wide at the heel and tapers to a point at the tip.

Boning Knife

A smaller knife with a thin blade used to separate meat from the bone. Blade is usually 12.5- to 17.5- cm long and may be flexible or rigid.

Paring Knife

A short knife that is used for detail work or cutting fruits and vegetables. Rigid blade is 5- to 10-cm long.

Meat Cleaver

Large, heavy rectangular blade used for chopping or cutting through bones.

Utility Knife

Rigid 15- to 20-cm long blade is shaped like a chef's knife but narrower.

Slicer

A knife with a long, thin blade used primarily for slicing cooked meat. A similar knife with a serrated edge is used for slicing bread or pastry items.

Butcher Knife

The rigid blade curve up in a 25- degree angle at the tip, this knife is used for fabricating raw meat and traipsing through the jungle.

Steel

Steel is uses to hone or straighten a blade immediately after and between sharpening.

Vegetable Cleaver

Used as a chef knife in Asian cuisine. Lighter weight than a meat cleaver with a thin sharp blade.

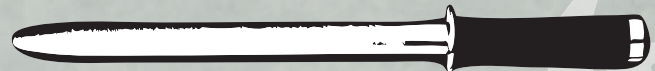
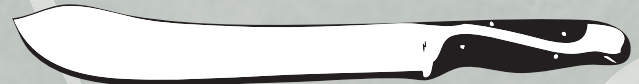
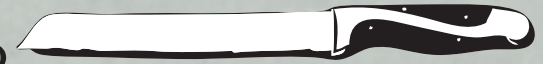

KNIFE NAMES - EXERCISE

Knife Shapes and Sharpening Equipment

Using the descriptions below, identify and write the name of the knife of each corresponding picture.

Rigid 20-to 35-cm long blade is wide at the heel and tapers to a point at the tip.



A smaller knife with a thin blade used to separate meat from the bone. Blade is usually 12.5- to 17.5- cm long and may be flexible or rigid.



A short knife that is used for detail work or cutting fruits and vegetables. Rigid blade is 5- to 10-cm long.



Large, heavy rectangular blade used for chopping or cutting through bones.



Rigid 15- to 20-cm long blade is shaped like a chef's knife but narrower.



A knife with a long, thin blade used primarily for slicing cooked meat. A similar knife with a serrated edge is used for slicing bread or pastry items.



The rigid blade curve up in a 25- degree angle at the tip, this knife is used for fabricating raw meat and traipsing through the jungle.

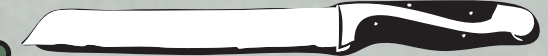

Steel is uses to hone or straighten a blade immediately after and between sharpening.

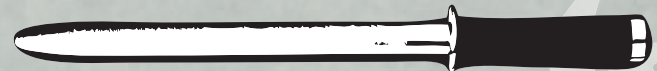
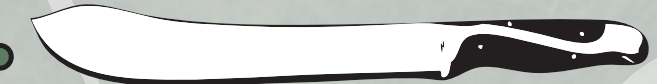

Used as a chef knife in Asian cuisine. Lighter weight than a meat cleaver with a thin sharp blade.



KNIFE NAMES - EXERCISE ANSWERS

Knife Shapes and Sharpening Equipment

Using the descriptions below, identify and write the name of the knife of each corresponding picture.

French or Chef's Knife

Rigid 20-to 35-cm long blade is wide at the heel and tapers to a point at the tip.

Boning Knife

A smaller knife with a thin blade used to separate meat from the bone. Blade is usually 12.5- to 17.5- cm long and may be flexible or rigid.

Paring Knife

A short knife that is used for detail work or cutting fruits and vegetables. Rigid blade is 5- to 10-cm long.

Meat Cleaver

Large, heavy rectangular blade used for chopping or cutting through bones.

Utility Knife

Rigid 15- to 20-cm long blade is shaped like a chef's knife but narrower.

Slicer

A knife with a long, thin blade used primarily for slicing cooked meat. A similar knife with a serrated edge is used for slicing bread or pastry items.

Butcher Knife

The rigid blade curve up in a 25- degree angle at the tip, this knife is used for fabricating raw meat and traipsing through the jungle.

Steel

Steel is uses to hone or straighten a blade immediately after and between sharpening.

Vegetable Cleaver

Used as a chef knife in Asian cuisine. Lighter weight than a meat cleaver with a thin sharp blade.

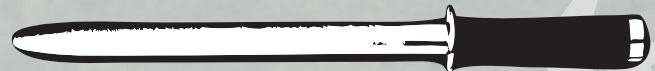
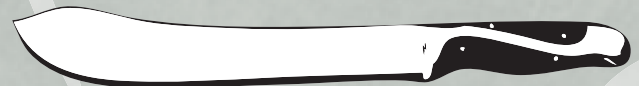
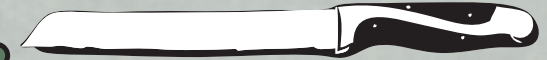



LESSON PLAN - WORK SECTIONS & THEIR STATIONS

From the kitchen of **TOOLS & EQUIPMENT**

■ Purpose and Practice:

- To review the work areas in a commercial kitchen
- To work together to complete a task

■ Ingredients

Page 98
(handout “Work Sections and Their Stations”)

Pages 99
5 color coded sets of “Work Sections and Their Stations”

■ Method

- Make copies of the handout that describes 6 Sections and their Stations and review with the class
- Prepares appropriate number of sets of the “Work Sections and their Stations” cutting out the section images and stations along the dotted lines, into small cards for a picture/description match exercise
- Shuffle each set so that the images of the sections and the definition of the stations are not in order
- Distribute a complete (shuffled) set to each group (2 to 5 students per group)
- Invite each group to work together (encouraging total participation) to match up the section image to the station name
- Review the matches

■ Cooking Time

30 minutes

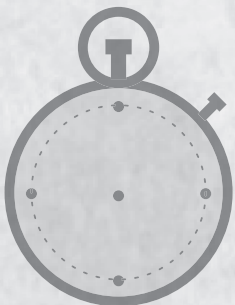

■ Essential Skills being practiced

- ✓ Thinking Skills
- ✓ Working With Others
- ✓ Document Use
- ✓ Oral Communication

Tip:

Have the teams get up and walk around to see what each other have selected as matches.





WORK SECTIONS AND THEIR STATIONS

Work stations are a work area in the kitchen dedicated to a particular task, such as broiling or salad making; work stations using the same or similar equipment for related tasks are grouped together.

Sections	Stations
Entrée Section	Broiler station Sauté/Sauce station
Garde-manger section	Salad greens cleaning Salad preparation Cold-foods preparation Sandwich station Showpiece preparation
Bakery and Desserts section	Dough holding and proofing Dough rolling and forming Baking and Cooling Dessert preparation Frozen dessert preparation Plating desserts
Banquet section	Steam cooking Holding and plating
Short-order section	Griddle station Fry station
Beverage section	Hot-beverage station Cold-beverage station Alcoholic beverage station

WORK SECTIONS AND THEIR STATIONS - WORDMATCH

Match the station to the appropriate section:

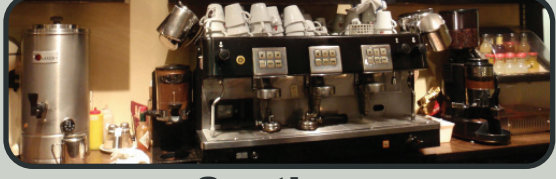
<p>SECTION</p> <p>Entrée</p>  <p>Section</p>	<p>STATION</p> <p>Broiler station Sauté/Sauce station</p>
<p>SECTION</p> <p>Garde-manger</p>  <p>Section</p>	<p>STATION</p> <p>Salad greens cleaning Salad preparation Cold-foods preparation Sandwich station Showpiece preparation</p>
<p>SECTION</p> <p>Bakery and Desserts</p>  <p>Section</p>	<p>STATION</p> <p>Dough holding and proofing Dough rolling and forming Baking and Cooling Dessert preparation Frozen dessert preparation Plating desserts</p>
<p>SECTION</p> <p>Banquet</p>  <p>Section</p>	<p>STATION</p> <p>Steam cooking Holding and plating</p>
<p>SECTION</p> <p>Short-order</p>  <p>Section</p>	<p>STATION</p> <p>Griddle station Fry station</p>
<p>SECTION</p> <p>Beverage</p>  <p>Section</p>	<p>STATION</p> <p>Hot-beverage station Cold-beverage station Alcoholic beverage station</p>



LESSON PLAN - HEAT DISTRIBUTION - FILL IN THE BLANKS

From the kitchen of _____ **TOOLS & EQUIPMENT**

■ Purpose and Practice:

- Reading material previously studied in class and remembering what was learned

■ Ingredients

Page 101
(learners' handout)

Page 102
(instructor's answer key)

■ Method

- Instructor prepares appropriate number of "Heat Distribution" handouts for the learners
- Individually, learners fill in the banks using the words provided to complete the passage.
- Instructor reviews the answers with the class in a group setting

■ Cooking Time

10 - 15 minutes



■ Essential Skills being practiced

- ✓ Reading Text
- ✓ Thinking Skills
- ✓ Writing
- ✓ Document Use

Tip: _____

COOKWARE - HEAT DISTRIBUTION - EXERCISE

Please read the information below and fill in the blanks using the words provided here:

thinner	conduct	gauge
heat	cookware	hot spots
		appropriate

_____ that fails to distribute _____ evenly may cause _____ that burn foods. Because different metals _____ heat at different rates, and thicker layers of metal conduct heat more evenly than _____ ones, the most important considerations when choosing cookware are the type and thickness (known as the _____) of the material used. No one cookware or material suits every process or need, however; always select the most _____ material for the task at hand.

COOKWARE - HEAT DISTRIBUTION - ANSWERS

Please read the information below and fill in the blanks using the words provided here:

thinner	conduct	gauge
heat	cookware	hot spots
		appropriate

cookware that fails to distribute heat evenly may cause hot spots that burn foods. Because different metals conduct heat at different rates, and thicker layers of metal conduct heat more evenly than thinner ones, the most important considerations when choosing cookware are the type and thickness (known as the gauge) of the material used. No one cookware or material suits every process or need, however; always select the most appropriate material for the task at hand.



LESSON PLAN - COPPER COOKWARE - FILL IN THE BLANKS

From the kitchen of _____ **TOOLS & EQUIPMENT**

■ **Purpose and Practice:**

- Reading material previously studied in class and remembering what was learned

■ **Ingredients**

Page 104
(learners' handout)

Page 105
(instructor's answer
key)

■ **Method**

- Instructor prepares appropriate number of "Copper Cookware" handouts for the learners
- Individually, learners fill in the banks using the words provided to complete the passage.
- Instructor reviews the answers with the class in a group setting

■ **Cooking Time**

10 - 15 minutes

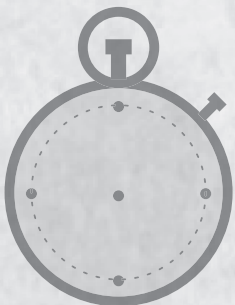

■ **Essential Skills being practiced**

- ✓ Reading Text
- ✓ Thinking Skills
- ✓ Writing
- ✓ Document Use

Tip: _____

COOKWARE - COPPER EXERCISE

Please read the information below and fill in the blanks using the words provided here:



expensive

tin

quickly

conductor

care

bottom

stainless steel

fruit

Copper is an excellent _____; it heats rapidly and evenly and cools _____ . Unlined copper pots are the best for cooking sugar and _____ mixtures. Copper cookware is very _____ .

It also requires a great deal of _____ and is often quite heavy.

Because copper may react with some foods, copper cookware usually has a _____ lining, which is soft and easily scratched. Because of these problems, copper is often sandwiched between layers of _____ or aluminum in the _____ of pots and pans.

COOKWARE - COPPER - ANSWERS

Please read the information below and fill in the blanks using the words provided here:



expensive

tin

quickly

conductor

care

bottom

stainless steel

fruit

Copper is an excellent conductor; it heats rapidly and evenly and cools quickly. Unlined copper pots are the best for cooking sugar and fruit mixtures. Copper cookware is very expensive.

It also requires a great deal of care and is often quite heavy.

Because copper may react with some foods, copper cookware usually has a tin lining, which is soft and easily scratched. Because of these problems, copper is often sandwiched between layers of stainless steel or aluminum in the bottom of pots and pans.



LESSON PLAN - ALUMINUM COOKWARE - FILL IN THE BLANKS

From the kitchen of _____ **TOOLS & EQUIPMENT**

■ **Purpose and Practice:**

- Reading material previously studied in class and remembering what was learned

■ **Ingredients**

Page 107
(learners' handout)

Page 108
(instructor's answer
key)

■ **Method**

- Instructor prepares appropriate number of "Aluminum Cookware" handouts for the learners
- Individually, learners fill in the banks using the words provided to complete the passage.
- Instructor reviews the answers with the class in a group setting

■ **Cooking Time**

10 - 15 minutes

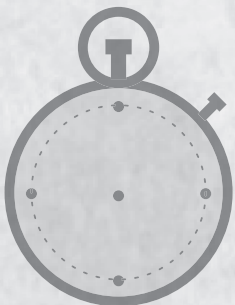

■ **Essential Skills being practiced**

- ✓ Reading Text
- ✓ Thinking Skills
- ✓ Writing
- ✓ Document Use

Tip: _____

COOKWARE - ALUMINUM EXERCISE

Please read the information below and fill in the blanks using the words provided here:

**acidic foods****soft****metal whisk****commercial****discolored****storage****sticking**

Aluminum is the metal used most commonly in _____ utensils. It is light-weight and, after copper, conducts heat best. Aluminum is a _____ metal, so it should be treated with care to avoid dents. Do not use aluminum containers for _____ or for cooking _____ because the metal reacts chemically with many foods. Light-colored foods, such as soups or sauces may be _____ when cooked in aluminum, especially if stirred with a _____ or spoon. Anodized aluminum has a hard, dark, corrosion-resistant surface that helps prevent _____ and discoloration.

COOKWARE - ALUMINUM - ANSWERS

Please read the information below and fill in the blanks using the words provided here:



acidic foods

soft

metal whisk

commercial

discolored

storage

sticking

Aluminum is the metal used most commonly in commercial utensils. It is light-weight and, after copper, conducts heat best. Aluminum is a soft metal, so it should be treated with care to avoid dents. Do not use aluminum containers for storage or for cooking acidic foods because the metal reacts chemically with many foods. Light-colored foods, such as soups or sauces may be discolored when cooked in aluminum, especially if stirred with a metal whisk or spoon. Anodized aluminum has a hard, dark, corrosion-resistant surface that helps prevent sticking and discoloration.



**LESSON PLAN - STAINLESS STEEL COOKWARE -
FILL IN THE BLANKS**

From the kitchen of **TOOLS & EQUIPMENT**

■ Purpose and Practice:

- Reading material previously studied in class and remembering what was learned

■ Ingredients

Page 110
(learners' handout)

Page 111
(instructor's answer
key)

■ Method

- Instructor prepares appropriate number of "Stainless Steel Cookware" handouts for the learners
- Individually, learners fill in the banks using the words provided to complete the passage.
- Instructor reviews the answers with the class in a group setting

■ Cooking Time

10 - 15 minutes

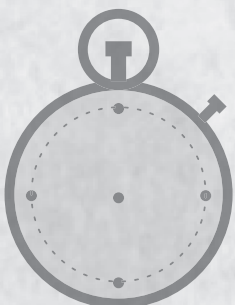

■ Essential Skills being practiced

- ✓ Reading Text
- ✓ Thinking Skills
- ✓ Writing
- ✓ Document Use

Tip:

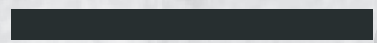

COOKWARE - STAINLESS STEEL EXERCISE

Please read the information below and fill in the blanks using the words provided here:



low-temperature

heat

aluminum

react

storage

hard

durability

core

Although stainless steel conducts and retains heat poorly, it is a _____, durable metal and very useful for holding foods and _____ cooking where hot spots and scorching are not problems. Stainless steel pots and pans are available with _____ or copper bonded to the bottom or with an aluminum layered _____.

Even though this special type of stainless steel cookware is expensive it combines the rapid, uniform _____ conductivity of copper and aluminum with the strength, _____ and nonreactivity of stainless steel.

Stainless steel is also ideal for _____ containers because it does not _____ with foods.

COOKWARE - STAINLESS STEEL - ANSWERS

Please read the information below and fill in the blanks using the words provided here:



low-temperature	heat	aluminum	react
storage	hard	durability	core

Although stainless steel conducts and retains heat poorly, it is a hard, durable metal and very useful for holding foods and low - temperature cooking where hot spots and scorching are not problems. Stainless steel pots and pans are available with aluminum or copper bonded to the bottom or with an aluminum layered core.

Even though this special type of stainless steel cookware is expensive it combines the rapid, uniform heat conductivity of copper and aluminum with the strength, durability and nonreactivity of stainless steel.

Stainless steel is also ideal for storage containers because it does not react with foods.



**LESSON PLAN - CAST IRON COOKWARE -
FILL IN THE BLANKS**

From the kitchen of **TOOLS & EQUIPMENT**

■ Purpose and Practice:

- Reading material previously studied in class and remembering what was learned

■ Ingredients

Page 113
(learners' handout)

Page 114
(instructor's answer
key)

■ Method

- Instructor prepares appropriate number of "Cast Iron Cookware" handouts for the learners
- Individually, learners fill in the banks using the words provided to complete the passage.
- Instructor reviews the answers with the class in a group setting

■ Cooking Time

10 - 15 minutes



■ Essential Skills being practiced

- ✓ Reading Text
- ✓ Thinking Skills
- ✓ Writing
- ✓ Document Use

Tip:

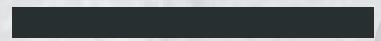

COOKWARE - CAST IRON EXERCISE

Please read the information below and fill in the blanks using the words provided here:



conditioned

heavy

holds

rust

griddles

Cast iron cookware distributes heat evenly and _____ high temperatures well. It is often used in _____ and large skillets. Although relatively inexpensive, cast iron is extremely _____ and brittle. It must be kept properly _____ and dry to prevent _____ and pitting.

COOKWARE - CAST IRON - ANSWERS

Please read the information below and fill in the blanks using the words provided here:



conditioned

heavy

holds

rust

griddles

Cast iron cookware distributes heat evenly and holds high temperatures well. It is often used in griddles and large skillets. Although relatively inexpensive, cast iron is extremely heavy and brittle. It must be kept properly conditioned and dry to prevent rust and pitting.



LESSON PLAN - GLASS COOKWARE - FILL IN THE BLANKS

From the kitchen of _____ **TOOLS & EQUIPMENT**

■ Purpose and Practice:

- Reading material previously studied in class and remembering what was learned

■ Ingredients

Page 116
(learners' handout)

Page 117
(instructor's answer key)

■ Method

- Instructor prepares appropriate number of "Glass Cookware" handouts for the learners
- Individually, learners fill in the banks using the words provided to complete the passage.
- Instructor reviews the answers with the class in a group setting

■ Cooking Time

10 - 15 minutes



■ Essential Skills being practiced

- ✓ Reading Text
- ✓ Thinking Skills
- ✓ Writing
- ✓ Document Use

Tip: _____

COOKWARE - GLASS EXERCISE

Please read the information below and fill in the blanks using the words provided here:



microwave

breakage

heat

react

metal

Glass retains _____ well but conducts it poorly. It does not _____ well with foods. Tempered glass is suitable for _____ cooking, provided it does not have any _____ band or decoration. Commercial operations rarely use glass cookware because of the danger of _____.

COOKWARE - GLASS - ANSWERS

Please read the information below and fill in the blanks using the words provided here:



microwave

breakage

heat

react

metal

Glass retains heat well but conducts it poorly. It does not react well with foods. Tempered glass is suitable for microwave cooking, provided it does not have any metal band or decoration. Commercial operations rarely use glass cookware because of the danger of breakage.



LESSON PLAN - CERAMIC COOKWARE - FILL IN THE BLANKS

From the kitchen of _____ **TOOLS & EQUIPMENT**

■ Purpose and Practice:

- Reading material previously studied in class and remembering what was learned

■ Ingredients

Page 119
(learners' handout)

Page 120
(instructor's answer key)

■ Method

- Instructor prepares appropriate number of "Ceramic Cookware" handouts for the learners.
- Individually, learners fill in the blanks using the words provided to complete the passage.
- Instructor reviews the answers with the class in a group setting.

■ Cooking Time

10 - 15 minutes

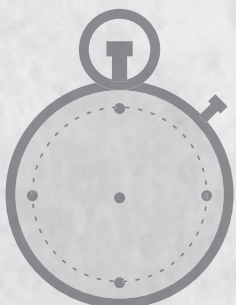

■ Essential Skills being practiced

- ✓ Reading Text
- ✓ Thinking Skills
- ✓ Writing
- ✓ Document Use

Tip: _____

COOKWARE - CERAMIC EXERCISE

Please read the information below and fill in the blanks using the words provided here:

microwave oven

retain

flame

casseroles

cracked

temperature



Ceramics, including earthenware, porcelain and stoneware, are used primarily for baking dishes, _____ and baking stones because they conduct heat uniformly and _____ temperatures well. Ceramics are nonreactive, inexpensive and generally suitable for use in a _____ (provided there is no metal in the glaze). Ceramics are easily chipped or _____, and should not be used over a direct _____. Quick _____ changes may cause the cookware to crack or shatter.

COOKWARE - CERAMIC - ANSWERS

Please read the information below and fill in the blanks using the words provided here:

microwave oven

retain

flame

casseroles

cracked

temperature



Ceramics, including earthenware, porcelain and stoneware, are used primarily for baking dishes, casseroles and baking stones because they conduct heat uniformly and retain temperatures well. Ceramics are nonreactive, inexpensive and generally suitable for use in a microwave oven (provided there is no metal in the glaze). Ceramics are easily chipped or cracked, and should not be used over a direct flame. Quick temperature changes may cause the cookware to crack or shatter.



LESSON PLAN - PLASTIC WARE - FILL IN THE BLANKS

From the kitchen of **TOOLS & EQUIPMENT**

Purpose and Practice:

- Reading material previously studied in class and remembering what was learned

Ingredients

Page 122
(learners' handout)

Page 123
(instructor's answer key)

Method

- Instructor prepares appropriate number of "Plastic Ware" handouts for the learners
- Individually, learners fill in the banks using the words provided to complete the passage.
- Instructor reviews the answers with the class in a group setting

Cooking Time

10 - 15 minutes



Essential Skills being practiced

- ✓ Reading Text
- ✓ Thinking Skills
- ✓ Writing
- ✓ Document Use

Tip:

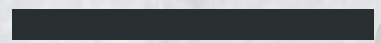

COOKWARE - PLASTIC WARE EXERCISE

Please read the information below and fill in the blanks using the words provided here:



resin

food storage

crack

microwave

inexpensive

heating

Plastic containers are frequently used in commercial kitchens for _____
 or service, but they can't be used for _____ or cooking except in a
 _____. Plastic microwave cookware is made of phenolic
 _____. It is easy to clean, fairly _____ and sturdy, but its
 glasslike structure is brittle and it can _____ or shatter.

COOKWARE - PLASTIC WARE - ANSWERS

Please read the information below and fill in the blanks using the words provided here:



resin

food storage

crack

microwave

inexpensive

heating

Plastic containers are frequently used in commercial kitchens for food storage or service, but they can't be used for heating or cooking except in a microwave. Plastic microwave cookware is made of phenolic resin. It is easy to clean, fairly inexpensive and sturdy, but its glasslike structure is brittle and it can crack or shatter.



LESSON PLAN - ENAMEL COOKWARE - FILL IN THE BLANKS

From the kitchen of _____ **TOOLS & EQUIPMENT**

■ Purpose and Practice:

- Reading material previously studied in class and remembering what was learned

■ Ingredients

Page 125
(learners' handout)

Page 126
(instructor's answer
key)

■ Method

- Instructor prepares appropriate number of "Enamel Cookware" handouts for the learners
- Individually, learners fill in the banks using the words provided to complete the passage.
- Instructor reviews the answers with the class in a group setting

■ Cooking Time

10 - 15 minutes

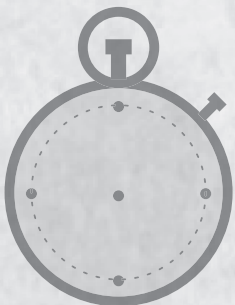

■ Essential Skills being practiced

- ✓ Reading Text
- ✓ Thinking Skills
- ✓ Writing
- ✓ Document Use

Tip: _____

COOKWARE - ENAMEL EXERCISE

Please read the information below and fill in the blanks using the words provided here:

bacteria**prohibited****crack****cooking****food poisoning**

Pans lined with enamel should not be used for _____; in many areas, their use in commercial kitchens is _____ by law. The enamel can chip or _____ easily, providing good places for _____ to grow.

Also, the chemicals used to bond the enamel to the cookware can cause _____ if ingested.

COOKWARE - ENAMEL - ANSWERS

Please read the information below and fill in the blanks using the words provided here:

bacteria**prohibited****crack****cooking****food poisoning**

Pans lined with enamel should not be used for cooking; in many areas, their use in commercial kitchens is prohibited by law. The enamel can chip or crack easily, providing good places for bacteria to grow.

Also, the chemicals used to bond the enamel to the cookware can cause food poisoning if ingested.



EGGS & BREAKFAST COOKERY



LESSON PLAN - COMPOSITION OF EGGS

From the kitchen of **EGGS & BREAKFAST COOKERY**

■ Purpose and Practice:

- To review information about eggs.

■ Ingredients

Page 129
handout called
"Composition of
Eggs Exercise"

Page 130
handout called
"Composition of
Eggs Answers"

■ Method

- (students will have already studied the Eggs and Breakfast Cookery Learning Guide)
- Instructor makes appropriate number of handouts for the class
- Instructor hands out "the exercise" sheet and asks the students to fill in the answer.
- Review answers with handout sheet called "Answers"
- Come together as a whole class to review the answers.

■ Cooking Time

20 minutes

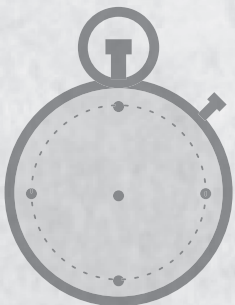

■ Essential Skills being practiced

- ✓ Thinking Skills
- ✓ Document Use
- ✓ Oral Communication
- ✓ Writing

Tip:

Students can make self-study cards by cutting the information into strips and folding them over.

COMPOSITION OF EGGS - EXERCISE

What are the 3 basic parts to an egg?

Answer:

True or false? Brown eggs are better than white eggs.

Answer:

Why should eggs be stored away from strong smelling products like onions?

Answer:

Name 2 nutritional qualities of an egg?

Answer:

Where is all the fat found in an egg?

Answer:

How can you tell that an egg is stale?

Answer:

COMPOSITION OF EGGS - ANSWERS

What are the 3 basic parts to an egg?	The shell, the yolk and the egg white.	Answer:
--	--	----------------

True or false? Brown eggs are better than white eggs.	False	Answer:
--	-------	----------------

Why should eggs be stored away from strong smelling products like onions?	Because the porous shell or “skin” absorbs odors.	Answer:
--	---	----------------

Name 2 nutritional qualities of an egg?	Good source of protein, iron, vitamin A, Vitamin D and phosphorous.	Answer:
--	---	----------------

Where is all the fat found in an egg?	In the egg yolk	Answer:
--	-----------------	----------------

How can you tell that an egg is stale?	The egg loses its transparency and it spreads over a larger area when cracked open.	Answer:
---	---	----------------



LESSON PLAN - GRADING EGGS

From the kitchen of **EGGS & BREAKFAST COOKERY**

■ Purpose and Practice:

- To review about the egg grading system in Canada

■ Ingredients

Page 132
handout called
"Grading Eggs -
Exercise"

Page 133
handout called
"Grading Eggs -
Answers"

■ Method

- (students will have already studied the Eggs and Breakfast Cookery Learning Guide)
- Instructor makes appropriate number of handouts for the class
- Instructor hands out "the exercise" sheet and asks the students to fill in the answer.
- Review answers with handout sheet called "Grading Eggs - Answers"
- Come together as a whole class to review the answers.

■ Cooking Time

20 minutes

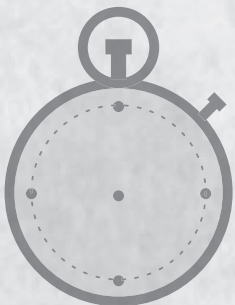

■ Essential Skills being practiced

- ✓ Thinking Skills
- ✓ Document Use
- ✓ Oral Communication
- ✓ Writing

Tip:

Students can make self-study cards by cutting the information into strips and folding them over.

GRADING EGGS - EXERCISE

<p>In Canada, eggs are graded as _____, _____, and _____.</p>	<p>Answer:</p>
<p>What does “candling” mean?</p>	<p>Answer:</p>
<p>In Canadian retail stores, what kind of symbol goes on all cartons of grades A and B eggs?</p>	<p>Answer:</p>
<p>Which grade eggs are not sold in stores?</p>	<p>Answer:</p>
<p>Only this grade egg is graded into size.</p>	<p>Answer:</p>
<p>What are some qualities of a grade A egg?</p>	<p>Answer:</p>
<p>How are grade B eggs normally used?</p>	<p>Answer:</p>
<p>How is a grade A egg different from a grade B egg?</p>	<p>Answer:</p>

GRADING EGGS - ANSWERS

<p>In Canada, eggs are graded as _____, _____, and _____.</p>	<p>A, B, and C.</p> <p style="text-align: right;">Answer:</p>
<p>What does “candling” mean?</p>	<p>The inspection of an egg by high intensity light to check quality of yolk and white.</p> <p style="text-align: right;">Answer:</p>
<p>In Canadian retail stores, what kind of symbol goes on all cartons of grades A and B eggs?</p>	<p>Maple Leaf</p> <p style="text-align: right;">Answer:</p>
<p>Which grade eggs are not sold in stores?</p>	<p>C</p> <p style="text-align: right;">Answer:</p>
<p>Only this grade egg is graded into size.</p>	<p>A</p> <p style="text-align: right;">Answer:</p>
<p>What are some qualities of a grade A egg?</p>	<p>All-purpose use especially where appearance is important like frying and poaching.</p> <p style="text-align: right;">Answer:</p>
<p>How are grade B eggs normally used?</p>	<p>For general cooking and baking where appearance is not so important</p> <p style="text-align: right;">Answer:</p>
<p>How is a grade A egg different from a grade B egg?</p>	<p>Grade A – normal shape, excellent interior</p> <p>Grade B – abnormal shape, yolks are oblong</p> <p style="text-align: right;">Answer:</p>



LESSON PLAN - STORING EGGS

From the kitchen of **EGGS & BREAKFAST COOKERY**

■ Purpose and Practice:

- To review information about egg storage.

■ Ingredients

Page 135
handout called
"Storing Eggs -
Exercise"

Page 136
handout called
"Storing Eggs -
Answers"

■ Method

- (students will have already studied the Eggs and Breakfast Cookery Learning Guide)
- Instructor makes appropriate number of handouts for the class
- Instructor hands out "the exercise" sheet and asks the students to fill in the answer.
- Review answers with handout sheet called "Storing Eggs - Answers"
- Come together as a whole class to review the answers.

■ Cooking Time

20 minutes

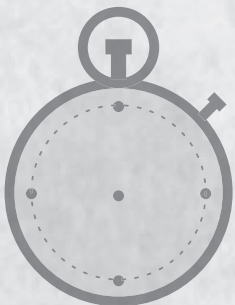

■ Essential Skills being practiced

- ✓ Thinking Skills
- ✓ Document Use
- ✓ Oral Communication
- ✓ Writing

Tip:

Students can make self-study cards by cutting the information into strips and folding them over.

STORING EGGS - EXERCISE

<p>What does CCP stand for and mean when storing eggs?</p>	<p>Answer:</p>
--	-----------------------

<p>How long can eggs last if stored at a temperature of 2-4°C (35°-40°F) and away from strong odors?</p>	<p>Answer:</p>
--	-----------------------

<p>How can you make egg yolks last up to 3 days?</p>	<p>Answer:</p>
--	-----------------------

<p>Before freezing egg yolks, what must you do?</p>	<p>Answer:</p>
---	-----------------------

<p>If egg whites are tightly covered, how long will they last in the fridge?</p>	<p>Answer:</p>
--	-----------------------

<p>Name 2 facts about Canada grade C eggs.</p>	<p>Answer:</p>
--	-----------------------

STORING EGGS - ANSWERS

<p>What does CCP stand for and mean when storing eggs?</p>	<p>Critical Control Point – keeps eggs at 4°C/40°F or colder. Safe temperature for refrigerated storage.</p> <p>Answer:</p>
<p>How long can eggs last if stored at a temperature of 2-4°C (35°-40°F) and away from strong odors?</p>	<p>Several months</p> <p>Answer:</p>
<p>How can you make egg yolks last up to 3 days?</p>	<p>Cover with water inside a tightly sealed container.</p> <p>Answer:</p>
<p>Before freezing egg yolks, what must you do?</p>	<p>Add salt and sugar</p> <p>Answer:</p>
<p>If egg whites are tightly covered, how long will they last in the fridge?</p>	<p>Up to one week</p> <p>Answer:</p>
<p>Name 2 facts about Canada grade C eggs.</p>	<p>Not sold to the public or food industry. No specific size or shape. Usually processed into commercially frozen, liquid and dried egg products.</p> <p>Answer:</p>



LESSON PLAN - MORE ABOUT EGGS!

From the kitchen of **EGGS & BREAKFAST COOKERY**

■ Purpose and Practice:

- To review information about eggs.

■ Ingredients

Page 138
handout called
"More about Eggs -
Exercise"

Page 139
handout called
"More about Eggs -
Answers"

■ Method

- (students will have already studied the Eggs and Breakfast Cookery Learning Guide)
- Instructor makes appropriate number of handouts for the class
- Instructor hands out "the exercise" sheet and asks the students to fill in the answer.
- Review answers with handout sheet called "More about Eggs - Answers"
- Come together as a whole class to review the answers.

■ Cooking Time

20 minutes

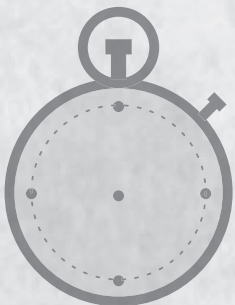

■ Essential Skills being practiced

- ✓ Thinking Skills
- ✓ Document Use
- ✓ Oral Communication
- ✓ Writing

Tip:

Students can make self-study cards by cutting the information into strips and folding them over.

MORE ABOUT EGGS! - EXERCISE

What size eggs are usually used in a recipe?	Answer:
What is a reconstituted egg?	Answer:
What is another word for dehydrated eggs?	Answer:
How long can reconstituted eggs stand unused?	Answer:
Once frozen eggs are thawed, up to how long can they be left thawed before using?	Answer:
Which part of the egg is used to clarify clear soups?	Answer:
Which part of the egg is used as an emulsifier to make a smooth butter sauce?	Answer:
How can eggs be used as a glaze?	Answer:
How would I use eggs for breading?	Answer:

MORE ABOUT EGGS! - ANSWERS

What size eggs are usually used in a recipe?	Large size	Answer:
What is a reconstituted egg?	Usually dried, frozen, shelled and egg mixes.	Answer:
What is another word for dehydrated eggs?	Dried or powdered	Answer:
How long can reconstituted eggs stand unused?	No more than 1 hour	Answer:
Once frozen eggs are thawed, up to how long can they be left thawed before using?	A few hours	Answer:
Which part of the egg is used to clarify clear soups?	The egg white	Answer:
Which part of the egg is used as an emulsifier to make a smooth butter sauce?	The egg yolk	Answer:
How can eggs be used as a glaze?	Brushed on foods	Answer:
How would I use eggs for breading?	Mix with water, milk or cream	Answer:

LESSON PLAN - METHODS OF COOKING EGGS - A



From the kitchen of **EGGS & BREAKFAST COOKERY**

■ Purpose and Practice:

- To review the methods of cooking eggs.

■ Ingredients

Page 141
handout called
"Method of
cooking Eggs -
Exercise"

Page 142
handout called
"Method of
cooking Eggs -
Answers"

■ Method

- (students will have already studied the Eggs and Breakfast Cookery Learning Guide)
- Instructor makes appropriate number of handouts for the class
- Instructor hands out "the exercise" sheet and asks the students to fill in the answer.
- Review answers with handout sheet called "Method of Cooking Eggs - Answers"
- Come together as a whole class to review the answers.

■ Cooking Time

20 minutes

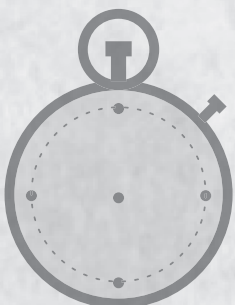

■ Essential Skills being practiced

- ✓ Thinking Skills
- ✓ Document Use
- ✓ Oral Communication
- ✓ Writing

Tip:

Students can make self-study cards by cutting the information into strips and folding them over.

METHODS OF COOKING EGGS - A

<p>Name 4 basic methods of cooking eggs.</p>	<p>Answer:</p>
--	-----------------------

<p>What is another word for a simmered egg?</p>	<p>Answer:</p>
---	-----------------------

<p>How do you poach an egg?</p>	<p>Answer:</p>
---------------------------------	-----------------------

<p>How do you cool a hard cooked egg quickly?</p>	<p>Answer:</p>
---	-----------------------

<p>How long can hard, cooled, peeled eggs last in the refrigerator?</p>	<p>Answer:</p>
---	-----------------------

<p>If an egg cracks while cooking in its shell, what can I do to stop it from leaking?</p>	<p>Answer:</p>
--	-----------------------

METHODS OF COOKING EGGS - A - ANSWERS

Name 4 basic methods of cooking eggs.	Simmering, frying, poaching, scrambling.	Answer:
--	--	----------------

What is another word for a simmered egg?	Boiled	Answer:
---	--------	----------------

How do you poach an egg?	Crack into a bowl, slide into barely simmering water (not boiling), add a touch of vinegar.	Answer:
---------------------------------	---	----------------

How do you cool a hard cooked egg quickly?	Run cold water over them	Answer:
---	--------------------------	----------------

How long can hard, cooled, peeled eggs last in the refrigerator?	2 to 3 days	Answer:
---	-------------	----------------

If an egg cracks while cooking in its shell, what can I do to stop it from leaking?	Add vinegar to the water	Answer:
--	--------------------------	----------------

LESSON PLAN - METHODS OF COOKING EGGS - B



From the kitchen of **EGGS & BREAKFAST COOKERY**

■ Purpose and Practice:

- To review the methods of cooking eggs.

■ Ingredients

Page 141
handout called
"Method of
cooking Eggs -
Exercise"

Page 142
handout called
"Method of
cooking Eggs -
Answers"

■ Method

- (students will have already studied the Eggs and Breakfast Cookery Learning Guide)
- Instructor makes appropriate number of handouts for the class
- Instructor hands out "the exercise" sheet and asks the students to fill in the answer.
- Review answers with handout sheet called "Method of Cooking Eggs - Answers"
- Come together as a whole class to review the answers.

■ Cooking Time

20 minutes

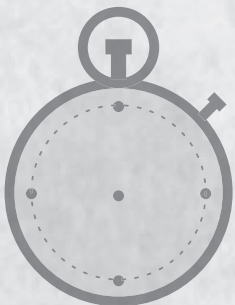

■ Essential Skills being practiced

- ✓ Thinking Skills
- ✓ Document Use
- ✓ Oral Communication
- ✓ Writing

Tip:

Students can make self-study cards by cutting the information into strips and folding them over.

METHODS OF COOKING EGGS - B

When should I use eggs that are cracked in shipping or in storage?

Answer:

What are shirred eggs?

Answer:

What are the small dishes used for shirring eggs called?

Answer:

If I mixed eggs and seasonings in a stainless steel bowl and poured the mixture into melted butter in a heated pan, then stirred the mixture until it coagulated, what would I be making?

Answer:

Over what type of heat do I scramble eggs?

Answer:

When should I turn out scrambled eggs?

Answer:

METHODS OF COOKING EGGS - B - ANSWERS

<p>When should I use eggs that are cracked in shipping or in storage?</p>	<p>Never!</p>	Answer:
--	---------------	----------------

<p>What are shirred eggs?</p>	<p>Eggs baked in small dishes until yolks are glazed over</p>	Answer:
--------------------------------------	---	----------------

<p>What are the small dishes used for shirring eggs called?</p>	<p>Ramekins</p>	Answer:
--	-----------------	----------------

<p>If I mixed eggs and seasonings in a stainless steel bowl and poured the mixture into melted butter in a heated pan, then stirred the mixture until it coagulated, what would I be making?</p>	<p>Scrambled eggs</p>	Answer:
---	-----------------------	----------------

<p>Over what type of heat do I scramble eggs?</p>	<p>Low</p>	Answer:
--	------------	----------------

<p>When should I turn out scrambled eggs?</p>	<p>Before they turn brown</p>	Answer:
--	-------------------------------	----------------



LESSON PLAN - BACON AND EGGS

From the kitchen of **EGGS & BREAKFAST COOKERY**

■ Purpose and Practice:

- To review what was learned about eggs in an interactive manner.

■ Ingredients

Study cards created from previous exercise

Page 147

4 Bacon and Eggs game boards (includes game board, team tokens and die)

■ Method Groups: up to 4 players per group

- Instructor explains that “Bacon and Eggs” is a game similar to “Snakes and Ladders” but with a cooking theme.
- Instructor asks players to put their game boards together and pick their team token. (each player will have a different team). Players also lay out the game cards in piles by category to the side of the board for easy access by all. Roll the die to see which team will be starting first. The team that rolls the highest die starts first.
- **To start:** One team member rolls die and starts at the square marked 1. If you land on a square with an end piece of bacon on it you slide up the bacon to the square it ends on. If you land on a square with eggs on it, you move down the board to the end of the arrow.
- If you land on a “regular” spot, decide which category of Egg question you would like to answer and the other team will ask you. Place that question card at the bottom of the category pile and continue the game.
- Continuing this way, teams will proceed to move along the board toward the end till one team reaches 100 and is declared the winner. You may only reach the end by rolling the exact number that it would take to get there.
- **Goal:** To answer as many questions as you can before a team player reaches the end.

■ Cooking Time

20 minutes and up

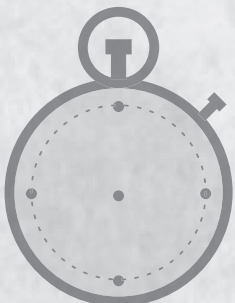

■ Essential Skills being practiced

- ✓ Thinking Skills
- ✓ Document Use
- ✓ Oral Communication

Tip:



SHOOTS & LADDERS EXERCISE 11 X 17 BOARD GAME



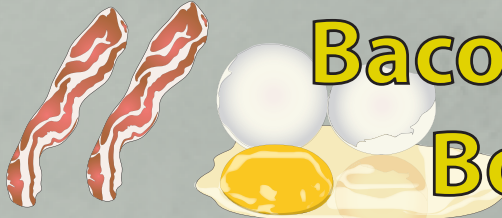

Essential Skills Companion Kit for Culinary Arts Trades Training Eggs and Breakfast Cookery



Bacon & Eggs Boardgame

100	99	98	97	96	95	94	93	92	91
81	82	83	84	85	86	87	88	89	90
80	79	78	77	76	75	74	73	72	71
61	62	63	64	65	66	67	68	69	70
60	59	58	57	56	55	54	53	52	51
41	42	43	44	45	46	47	48	49	50
40	39	38	37	36	35	34	33	32	31
21	22	23	24	25	26	27	28	29	30
20	19	18	17	16	15	14	13	12	11
1	2	3	4	5	6	7	8	9	10

Game pieces



LESSON PLAN - EGG SIZES

From the kitchen of **EGGS & BREAKFAST COOKERY**

■ Purpose and Practice:

- To review 6 different sizes of eggs.

■ Ingredients

Page 149
 called "Egg Sizes"
 (1 sheet = 4
 handouts)

■ Method

- Instructor copies and cuts handouts for the class.
- Instructor gives a handout to each student.
- Students review information together or on their own

■ Cooking Time

10 minutes



■ Essential Skills being practiced

- ✓ Thinking Skills
- ✓ Document Use

Tip: [REDACTED]

Egg Sizes

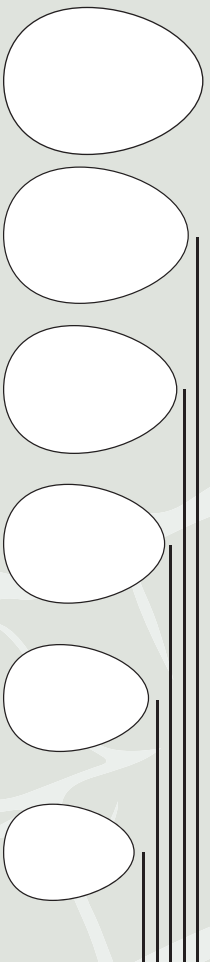

Jumbo	Extra Large	Large	Medium	Small	Pee wee
more than 69 g	64 g - 69 g	56 g - 63 g	49 g - 55 g	42 g - 48 g	less than 42 g

Egg Sizes

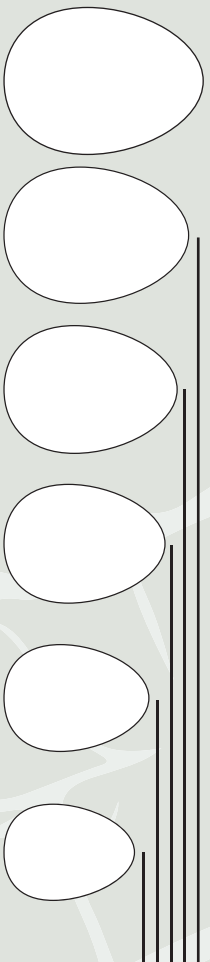

Jumbo	Extra Large	Large	Medium	Small	Pee wee
more than 69 g	64 g - 69 g	56 g - 63 g	49 g - 55 g	42 g - 48 g	less than 42 g

Egg Sizes

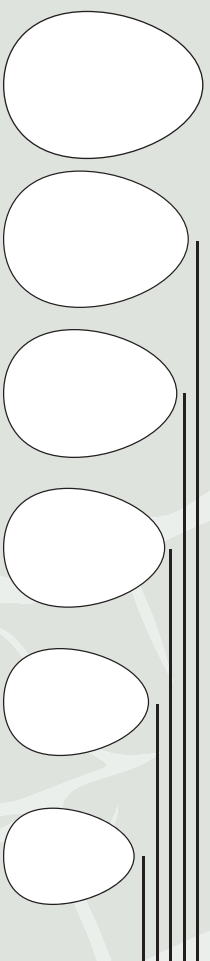

Jumbo	Extra Large	Large	Medium	Small	Pee wee
more than 69 g	64 g - 69 g	56 g - 63 g	49 g - 55 g	42 g - 48 g	less than 42 g

Egg Sizes

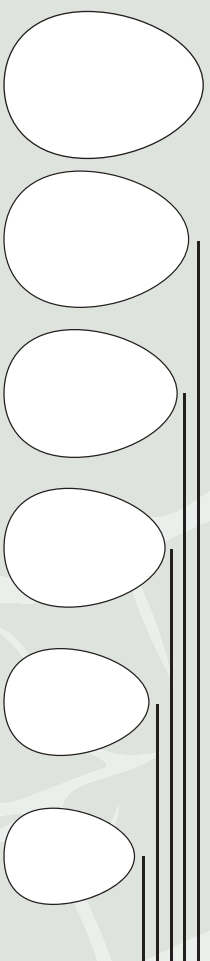

Jumbo	Extra Large	Large	Medium	Small	Pee wee
more than 69 g	64 g - 69 g	56 g - 63 g	49 g - 55 g	42 g - 48 g	less than 42 g



LESSON PLAN - PARTS OF AN EGG

From the kitchen of **EGGS & BREAKFAST COOKERY**

■ Purpose and Practice:

- To be able to identify the parts of an egg.

■ Ingredients

Page 151
handout called
"The Parts of an
Egg - Exercise"

Page 152
handout called
"The Parts of an
Egg - Answers"

■ Method

- (students will have already studied the Eggs and Breakfast Cookery Learning Guide)
- Instructor makes appropriate number of handouts for the class
- Instructor hands out "the exercise" sheet and asks the students to fill in the parts of an egg.
- Review answers with students then handout the answer sheet.

■ Cooking Time

20 minutes

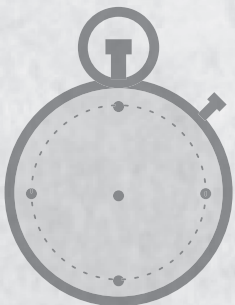

■ Essential Skills being practiced

- ✓ Thinking Skills
- ✓ Document Use

Tip:

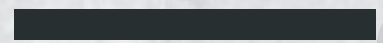

PARTS OF AN EGG - EXERCISE

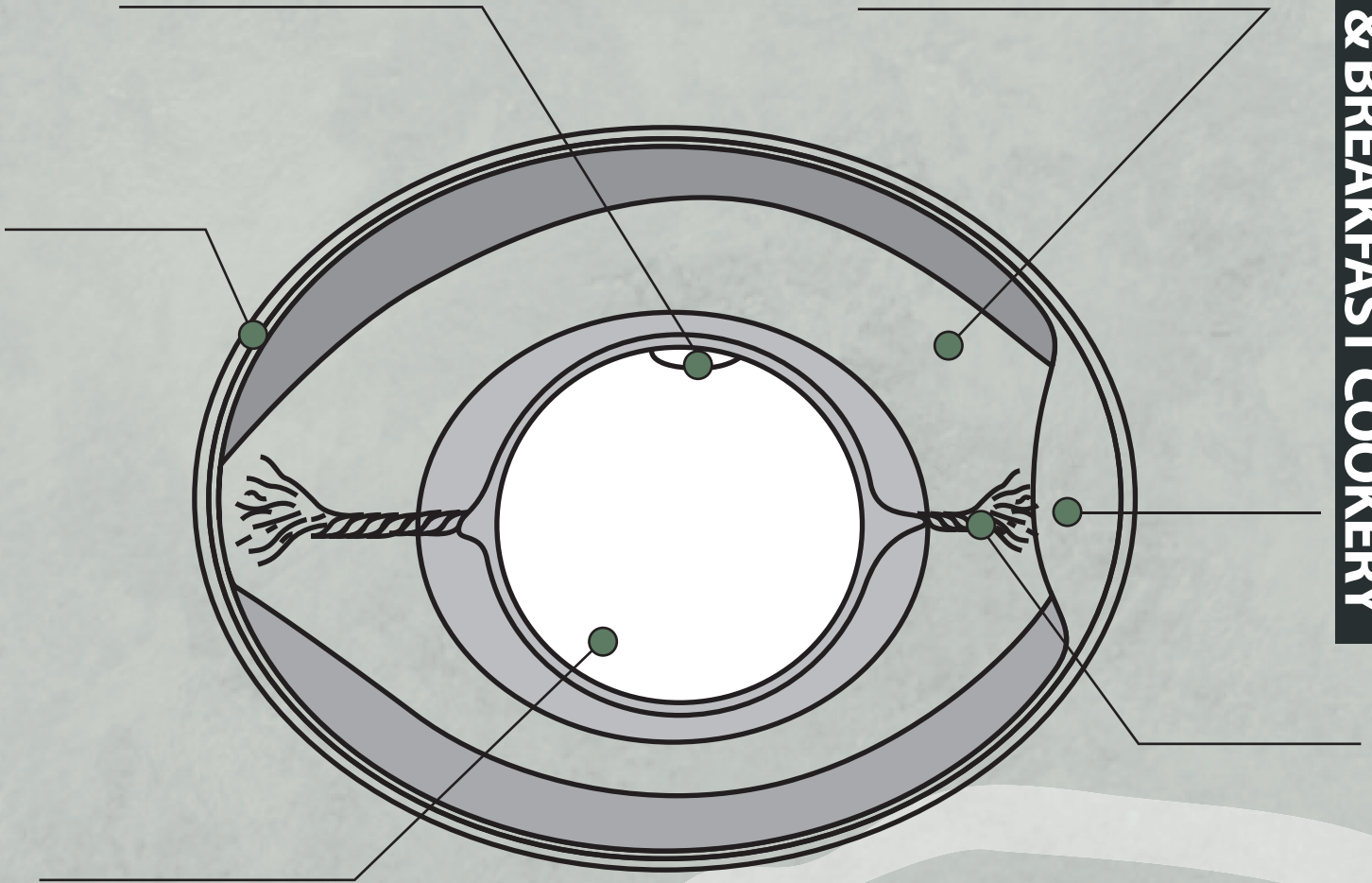

- Yolk
- Chalaza
- Air Cell
- Shell (Largely Calcium)
- Germination spot
- Albumen (Egg White)

Using the picture and the words above, decide what part of the egg is indicated by the green dots.

PARTS OF AN EGG - EXERCISE - ANSWERS

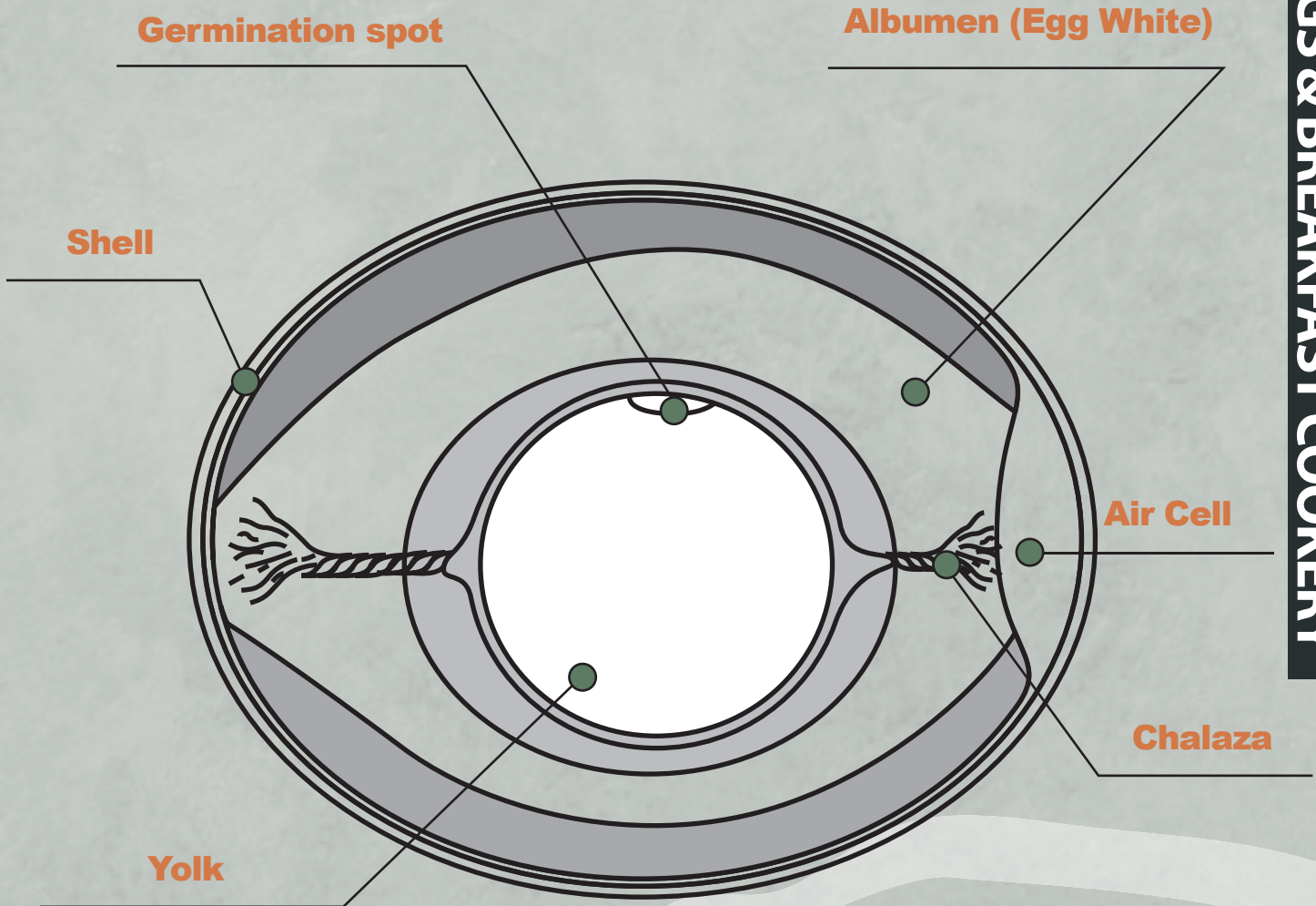

- Yolk
- Shell (Largely Calcium)
- Chalaza
- Germination spot
- Air Cell
- Albumen (Egg White)



LESSON PLAN - EGG GRADES

From the kitchen of **EGGS & BREAKFAST COOKERY**

■ Purpose and Practice:

- To review qualities of Grade A, B and C eggs.

■ Ingredients

Page 154
handout called
``Egg Grades``

Page 155
Egg Grade study
card (1 sheet = 4
study cards)

■ Method

- (students will have already studied the ``Eggs and Breakfast Cookery Learning Guide)
- Instructor makes appropriate number of handouts for the class
- Instructor hands out ``the egg grades study cards`` and reviews information with the class.

■ Cooking Time

20 minutes

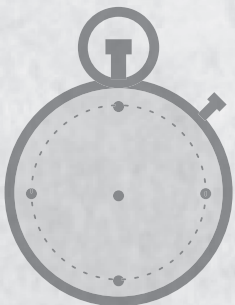

■ Essential Skills being practiced

- ✓ Thinking Skills
- ✓ Document Use

Tip:



EGG GRADES

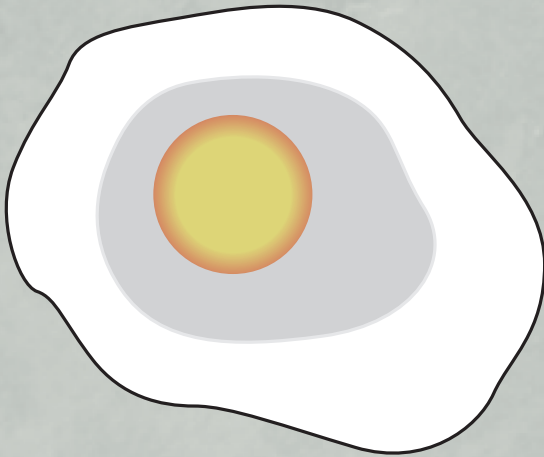

GRADE A

GRADE A

Albumen	Firm
Yolk	Rounded, well centered
Shell	Clean, no cracks, normal shape
Use	Sold at retail markets for household use

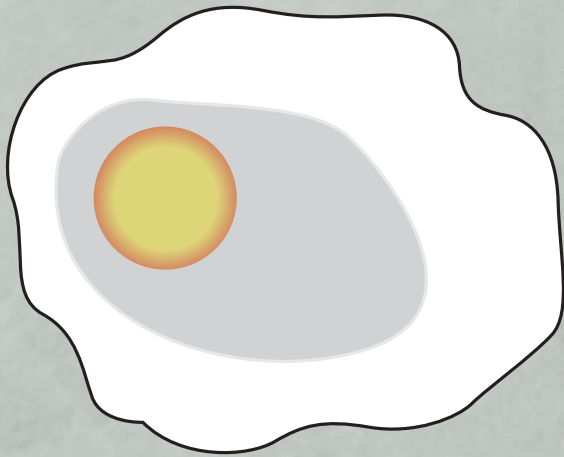

GRADE B

GRADE B

Albumen	Watery
Yolk	Slightly flattened
Shell	No cracks but rough texture
Use	Used for commercial baking or further processing

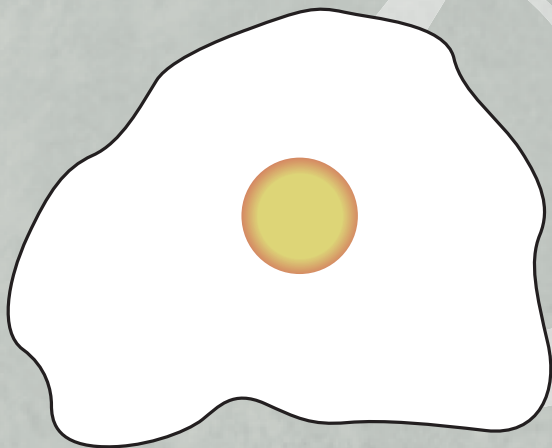

GRADE C

GRADE C

Albumen	Thin and watery
Yolk	Loose
Shell	May be cracked
Use	Not sold to consumers; sold to commercial processors for further processing

Egg Grades

EGGS & BREAKFAST COOKERY

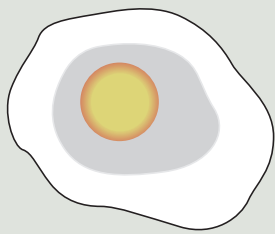

GRADE A

- GRADE A**
- Albumen** Firm
 - Yolk** Rounded, well centered
 - Shell** Clean, no cracks, normal shape
 - Use** Sold at retail markets for household use

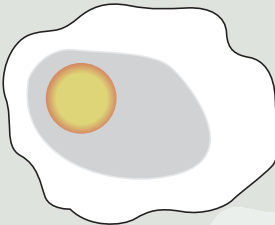

GRADE B

- GRADE B**
- Albumen** Watery
 - Yolk** Slightly flattened
 - Shell** No cracks but rough texture
 - Use** Used for commercial baking or further processing

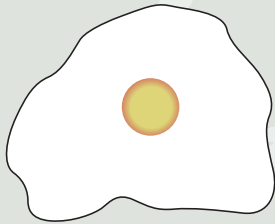

GRADE C

- GRADE C**
- Albumen** Thin and watery
 - Yolk** Loose
 - Shell** May be cracked
 - Use** Not sold to consumers; sold to commercial processors for further processing

Egg Grades

EGGS & BREAKFAST COOKERY

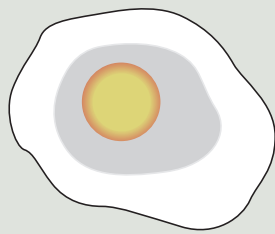

GRADE A

- GRADE A**
- Albumen** Firm
 - Yolk** Rounded, well centered
 - Shell** Clean, no cracks, normal shape
 - Use** Sold at retail markets for household use

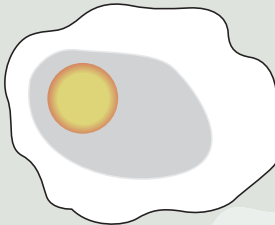

GRADE B

- GRADE B**
- Albumen** Watery
 - Yolk** Slightly flattened
 - Shell** No cracks but rough texture
 - Use** Used for commercial baking or further processing

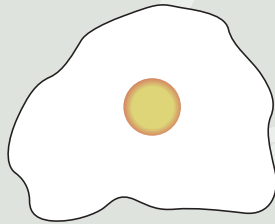

GRADE C

- GRADE C**
- Albumen** Thin and watery
 - Yolk** Loose
 - Shell** May be cracked
 - Use** Not sold to consumers; sold to commercial processors for further processing

Egg Grades

EGGS & BREAKFAST COOKERY

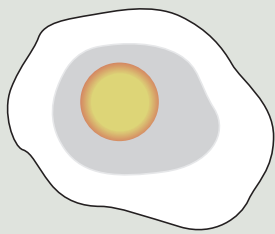

GRADE A

- GRADE A**
- Albumen** Firm
 - Yolk** Rounded, well centered
 - Shell** Clean, no cracks, normal shape
 - Use** Sold at retail markets for household use

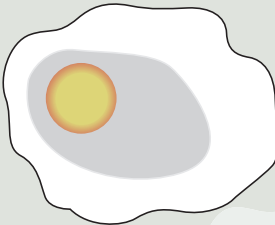

GRADE B

- GRADE B**
- Albumen** Watery
 - Yolk** Slightly flattened
 - Shell** No cracks but rough texture
 - Use** Used for commercial baking or further processing

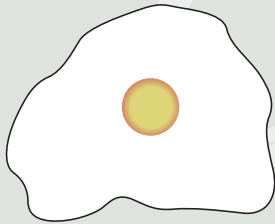

GRADE C

- GRADE C**
- Albumen** Thin and watery
 - Yolk** Loose
 - Shell** May be cracked
 - Use** Not sold to consumers; sold to commercial processors for further processing

Egg Grades

EGGS & BREAKFAST COOKERY

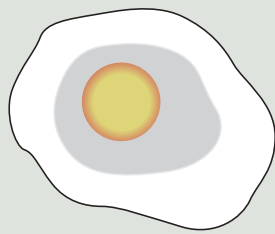

GRADE A

- GRADE A**
- Albumen** Firm
 - Yolk** Rounded, well centered
 - Shell** Clean, no cracks, normal shape
 - Use** Sold at retail markets for household use

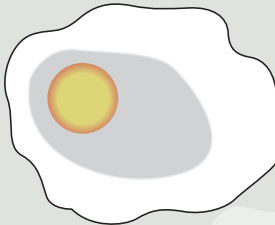

GRADE B

- GRADE B**
- Albumen** Watery
 - Yolk** Slightly flattened
 - Shell** No cracks but rough texture
 - Use** Used for commercial baking or further processing

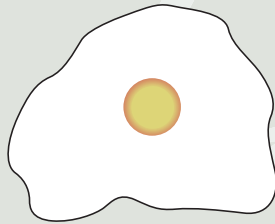

GRADE C

- GRADE C**
- Albumen** Thin and watery
 - Yolk** Loose
 - Shell** May be cracked
 - Use** Not sold to consumers; sold to commercial processors for further processing



LESSON PLAN - EGG VARIETIES

From the kitchen of **EGGS & BREAKFAST COOKERY**

■ Purpose and Practice:

- To review 6 varieties of eggs.

■ Ingredients

Page 157
handout called
“Egg Varieties”

Page 158
Egg Varieties
Pocket Card

■ Method

- Instructor makes appropriate number of handouts for the class
- Instructor hands out “Egg Varieties” sheet for the students to use as a reference.
- Instructor reviews the information with the class.
- Instructor hands out a “pocket card” version of the information.

■ Cooking Time

20 minutes

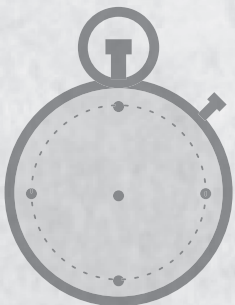

■ Essential Skills being practiced

- ✓ Thinking Skills
- ✓ Document Use

Tip:

Students can be encouraged to carry the card and quiz each other.

EGG VARIETIES

Eggs are one of nature's most nutritious foods.

From only 70 calories, an egg supplies every amino acid the human body needs as well as protein, minerals and vitamins, including vitamin D. With the exception of the Omega-3 enhanced, all eggs have the same nutritional value.

In BC, we purchase a greater variety of eggs than anywhere else in Canada, choosing from six types of eggs our farmers offer:



- **Free range** Free-range eggs are from hens that have access to an outdoor area.
- **Free run** Free-run eggs are from hens that are free to roam about on the barn floor.
- **Certified organic** Certified organic eggs are from free-range hens fed a certified organic diet and raised in accordance with guidelines issued by certified organizations.
- **Omega-3 enhanced** Omega-3 enhanced eggs are from hens that are fed an all-vegetarian diet with significant amounts of ground flaxseed.
- **Classic brown** Traditionally farmed, classic brown eggs are from breeds of hens with brown feathers, which lay brown-shelled eggs.
- **Classic white** Traditionally farmed, classic white eggs are from breeds of hens such as the white leghorn with white feathers, which lay white-shelled eggs.

Egg Varieties

Eggs are one of nature's most nutritious foods.

From only 70 calories, an egg supplies every amino acid the human body needs as well as protein, minerals and vitamins, including vitamin D. With the exception of the Omega-3 enhanced, all eggs have the same nutritional value.

In BC, we purchase a greater variety of eggs than anywhere else in Canada, choosing from six types of eggs our farmers offer:



EGGS & BREAKFAST COOKERY

- **Free range** Free-range eggs are from hens that have access to an outdoor area.
- **Free run** Free-run eggs are from hens that are free to roam about on the barn floor.
- **Certified organic** Certified organic eggs are from free-range hens fed a certified organic diet and raised in accordance with guidelines issued by certified organizations.
- **Omega-3 enhanced** Omega-3 enhanced eggs are from hens that are fed an all-vegetarian diet with significant amounts of ground flaxseed.
- **Classic brown** Traditionally farmed, classic brown eggs are from breeds of hens with brown feathers, which lay brown-shelled eggs.
- **Classic white** Traditionally farmed, classic white eggs are from breeds of hens such as the white leghorn with white feathers, which lay white-shelled eggs.

Egg Varieties

Eggs are one of nature's most nutritious foods.

From only 70 calories, an egg supplies every amino acid the human body needs as well as protein, minerals and vitamins, including vitamin D. With the exception of the Omega-3 enhanced, all eggs have the same nutritional value.

In BC, we purchase a greater variety of eggs than anywhere else in Canada, choosing from six types of eggs our farmers offer:



EGGS & BREAKFAST COOKERY

- **Free range** Free-range eggs are from hens that have access to an outdoor area.
- **Free run** Free-run eggs are from hens that are free to roam about on the barn floor.
- **Certified organic** Certified organic eggs are from free-range hens fed a certified organic diet and raised in accordance with guidelines issued by certified organizations.
- **Omega-3 enhanced** Omega-3 enhanced eggs are from hens that are fed an all-vegetarian diet with significant amounts of ground flaxseed.
- **Classic brown** Traditionally farmed, classic brown eggs are from breeds of hens with brown feathers, which lay brown-shelled eggs.
- **Classic white** Traditionally farmed, classic white eggs are from breeds of hens such as the white leghorn with white feathers, which lay white-shelled eggs.

Egg Varieties

Eggs are one of nature's most nutritious foods.

From only 70 calories, an egg supplies every amino acid the human body needs as well as protein, minerals and vitamins, including vitamin D. With the exception of the Omega-3 enhanced, all eggs have the same nutritional value.

In BC, we purchase a greater variety of eggs than anywhere else in Canada, choosing from six types of eggs our farmers offer:



EGGS & BREAKFAST COOKERY

- **Free range** Free-range eggs are from hens that have access to an outdoor area.
- **Free run** Free-run eggs are from hens that are free to roam about on the barn floor.
- **Certified organic** Certified organic eggs are from free-range hens fed a certified organic diet and raised in accordance with guidelines issued by certified organizations.
- **Omega-3 enhanced** Omega-3 enhanced eggs are from hens that are fed an all-vegetarian diet with significant amounts of ground flaxseed.
- **Classic brown** Traditionally farmed, classic brown eggs are from breeds of hens with brown feathers, which lay brown-shelled eggs.
- **Classic white** Traditionally farmed, classic white eggs are from breeds of hens such as the white leghorn with white feathers, which lay white-shelled eggs.

Egg Varieties

Eggs are one of nature's most nutritious foods.

From only 70 calories, an egg supplies every amino acid the human body needs as well as protein, minerals and vitamins, including vitamin D. With the exception of the Omega-3 enhanced, all eggs have the same nutritional value.

In BC, we purchase a greater variety of eggs than anywhere else in Canada, choosing from six types of eggs our farmers offer:



EGGS & BREAKFAST COOKERY

- **Free range** Free-range eggs are from hens that have access to an outdoor area.
- **Free run** Free-run eggs are from hens that are free to roam about on the barn floor.
- **Certified organic** Certified organic eggs are from free-range hens fed a certified organic diet and raised in accordance with guidelines issued by certified organizations.
- **Omega-3 enhanced** Omega-3 enhanced eggs are from hens that are fed an all-vegetarian diet with significant amounts of ground flaxseed.
- **Classic brown** Traditionally farmed, classic brown eggs are from breeds of hens with brown feathers, which lay brown-shelled eggs.
- **Classic white** Traditionally farmed, classic white eggs are from breeds of hens such as the white leghorn with white feathers, which lay white-shelled eggs.



SOUPS, STOCKS AND SAUCES



LESSON PLAN - SOUPS, STOCKS & SAUCES - STOCK VOCABULARY

From the kitchen of **SOUP STOCKS & SAUCES**

■ Purpose and Practice:

- Word definition match of 10 vocabulary terms related to making stocks, soups and sauces.
- Practice working in a team in order to match up the best possible word to the definition

■ Ingredients

Page161
Stocks Word match
- Study Sheet

Pages 162, 163, 164
handouts word
match

■ Method

- (students will have already studied the ``Soups, Stocks and Sauces Learning Guide)
- Instructor makes appropriate number of handouts of “Stocks Word Match – Study Sheet” for the class.
- Copy four sets of word match on card stock and cut out the pieces on the dotted lines.
- In groups of 2-3 hand out one set of word match cards per group
- Ask the students to match the word on the cracker to the bowl of soup to review vocabulary.
- Instructor hands out the “Stocks Word Match – Study Sheet” to the class to review.

■ Cooking Time

30 minutes



■ Essential Skills being practiced

- ✓ Thinking Skills
- ✓ Working With Others
- ✓ Document Use
- ✓ Reading Text
- ✓ Oral Communication

Tip:

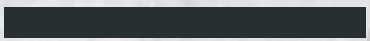

STOCKS - STUDY SHEET**aromatics**

A food added to enhance the natural aromas of another food such as herbs and spices and some vegetables.

(court) bouillon

Stock simmered with vegetables, seasonings and an acidic product like vinegar or wine

bouquet garni

Fresh herbs and vegetables tied into a bundle with twine and used to flavour stocks, sauces, soups and stews.

caramelization

The process of cooking sugars (for example: onions or browning bones for stock); the browning of sugar enhances the flavour and appearance of food.

clarification

The process of transforming a broth into a clear consommé by trapping impurities with a clearmeat consisting of the egg white protein albumen, ground meat, an acidic product, mirepoix and other ingredients.

pan drippings

The concentrated juices, drippings and bits of food left in a pan after foods are roasted or sautéed; it is used to flavour sauces made directly in the pan.

fumet

A stock made from fish bones and vegetables simmered in a liquid with flavourings.

glaze/glace

The dramatic reduction and concentration of a stock.

sachet

Aromatic ingredients tied in a cheesecloth bag and used to flavour stocks and other foods; usually contains parsley stems, peppercorns, dried thyme, bay leaves, cloves and garlic.

simmer

Maintaining the temperature of a liquid just below the boiling point.

STOCKS - WORDMATCH EXERCISE

aromatics

A food added to enhance the natural aromas of another food such as herbs and spices and some vegetables.

(court) bouillon

Stock simmered with vegetables, seasonings and an acidic product like vinegar or wine.

bouquet garni

Fresh herbs and vegetables tied into a bundle with twine and used to flavour stocks, sauces, soups and stews.

caramelization

The process of cooking sugars (for example: onions or browning bones for stock); the browning of sugar enhances the flavour and appearance of food.

clarification

The process of transforming a broth into a clear consommé by trapping impurities with a clearmeat consisting of the egg white protein albumen, ground meat, an acidic product, mirepoix and other ingredients.

pan drippings

The concentrated juices, drippings and bits of food left in a pan after foods are roasted or sautéed; it is used to flavour sauces made directly in the pan.

fumet

A stock made from fish bones and vegetables simmered in a liquid with flavourings.

glaze/glace

The dramatic reduction and concentration of a stock.

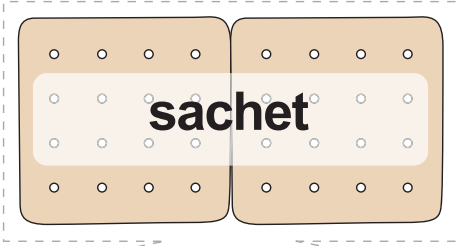

Aromatic ingredients tied in a cheesecloth bag and used to flavour stocks and other foods; usually contains parsley stems, peppercorns, dried thyme, bay leaves, cloves and garlic.

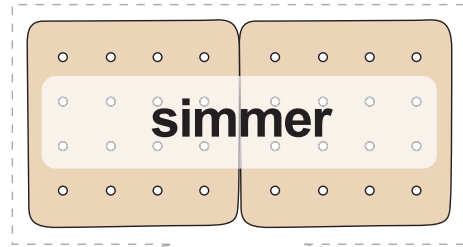

Maintaining the temperature of a liquid just below the boiling point.



LESSON PLAN - THE VELOUTE FAMILY

From the kitchen of **SOUP STOCKS & SAUCES**

■ Purpose and Practice:

- To review the information about types of sauces that can be made from Fish and White Stock.

■ Ingredients

Page 166
handout "the
Veloute Family"

Page 167
handout "the
Veloute Family
Con't"

■ Method

- (students will have already studied the "Soups, Stocks and Sauces Learning Guide)
- Instructor makes appropriate number of handouts for the class
- Instructor hands out "the Veloute Family" and "the Veloute Family Con't" to review the information with the class.

■ Cooking Time

20 minutes

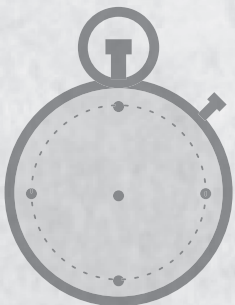

■ Essential Skills being practiced

✓ Document Use

Tip:



THE VELOUTE FAMILY

Veloute sauces are made by thickening a fish stock or white stock with roux.*

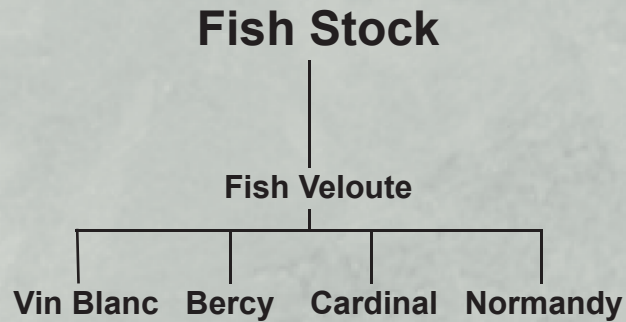

- **Vin Blanc:** white wine
- **Bercy:** shallots, butter heavy cream, parsley and lemon juice
- **Cardinal:** fish fumet, béchamel, fish veloute, heavy cream, cayenne pepper, lobster butter, brandy and garnish
- **Normandy:** mushroom trimmings, shellfish liquor, lemon juice, egg-yolk and cream liaison.

**roux – a cooked mixture of equal parts flour and fat, by weight; used as a thickener for sauces and other dishes.*

THE VELOUTE FAMILY (CON'T)

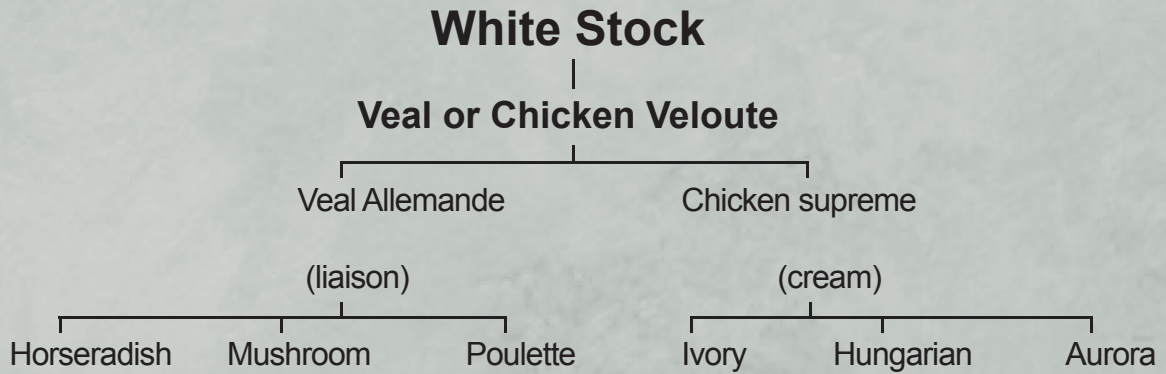

- **Allemande** sauce is made by adding lemon juice, veal stock and mushrooms to a veal veloute and finishing it with a liaison:
 - **Horseradish** – cream, dry mustard, fresh grated horseradish added just before serving(don't cook horseradish with the sauce)
 - **Mushroom** – mushrooms, butter, white wine, garnished with parsley and chives
 - **Poulette** – mushrooms, shallots, butter, finished with lemon juice and chopped parsley
- **Supreme sauce** is made by reducing cream and chicken stock:
 - **Ivory** – add glace de volaille to supreme sauce
 - **Hungarian** – onion, butter, paprika, white wine and cream
 - **Aurora** – tomato sauce, cream and butter



LESSON PLAN - THE BROWN STOCK FAMILY

From the kitchen of **SOUP STOCKS & SAUCES**

■ Purpose and Practice:

- To review the information about types of sauces that can be made from Brown Stock

■ Ingredients

Page 169
handout "The
Brown Stock
Family"

■ Method

- (students will have already studied the "Soups, Stocks and Sauces Learning Guide)
- Instructor makes appropriate number of handouts for the class
- Instructor hands out "Brown Stock Family" and reviews information with the class.

■ Cooking Time

20 minutes

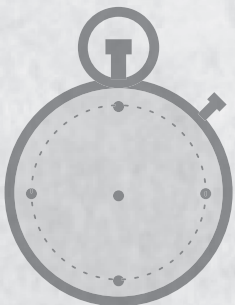

■ Essential Skills being practiced

✓ Document Use

Tip:



THE ESPAGNOLE (BROWN SAUCE) FAMILY

Made of brown stock, mirepoix* and tomatoes, thickened with brown roux; often used to produce demi-glace.

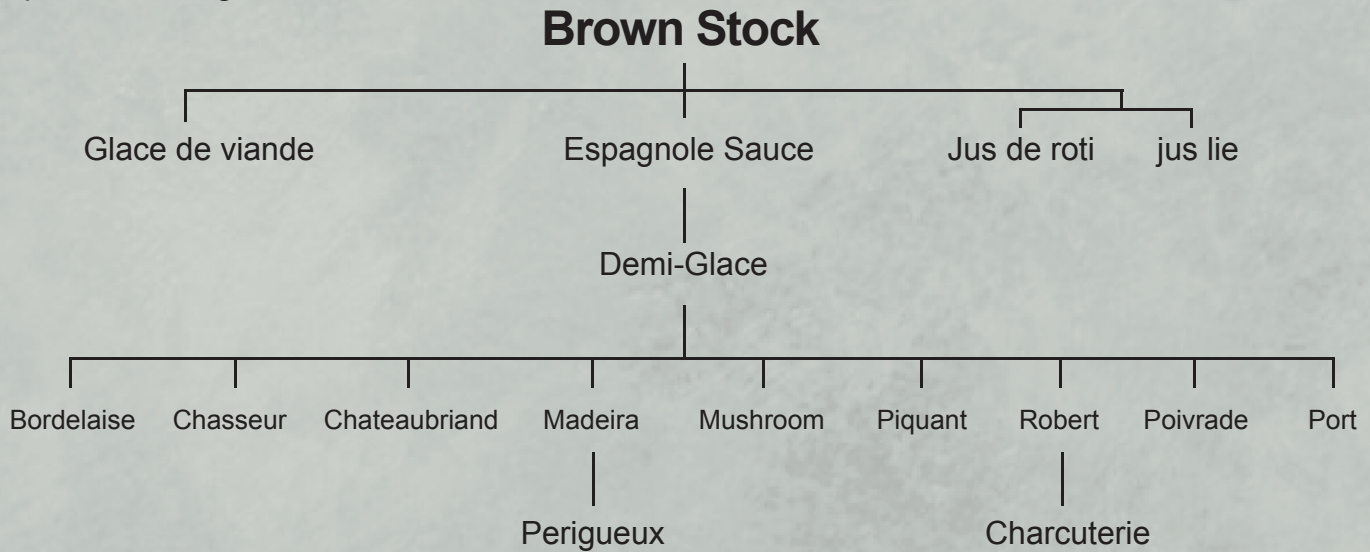

- **Demi-glace** – half brown sauce and half brown stock, reduced by half and used to produce many derivative sauces

Demi-glace is the based used to make the following derivative sauces:

- **Bordelaise** - chopped shallots, bay leaf, thyme, chopped peppercorns and dry red wine.
- **Chasseur (Hunter's Sauce)** – diced shallots, sliced mushrooms, butter, white wine, brandy and tomato concasse.
- **Chateaubriand** – sliced shallots, mushrooms, butter, thyme, bay leaves and white wine.
- **Madeira** – made with Madeira wine
- **Perigueux** – add finely diced truffles to Madeira sauce
- **Mushroom** – shallots, sliced mushrooms, butter with red, white or Madeira wine.
- **Piquant** – shallots, white wine and white wine vinegar, cracked peppercorns. Simmer with demi-glace, then add diced cornichons, capers, fresh tarragon, parsley and chervil.
- **Robert** – chopped onion, butter, dry white wine, dry mustard, wine and meat glaze.
- **Charcuterie** – Robert sauce garnished with sliced julienne of sour pickles (cornichons)
- **Poivrade** – mirepoix, butter, bay leaf, thyme, parsley stems, crushed garlic, clove, white wine, white wine vinegar (can also be done with red wine and red wine vinegar), crushed peppercorns, meat glaze.
- **Port** – made with Port

***mirepoix** – a mixture of coarsely chopped onions, carrots and celery used to flavour stocks, stews and other foods (50% onions, 25% carrots, 25% celery)



LESSON PLAN - THE HOLLANDAISE FAMILY

From the kitchen of **SOUP STOCKS & SAUCES**

■ Purpose and Practice:

- To review the information about types of sauces that can be made from Hollandaise and Béarnaise Derivatives.

■ Ingredients

Page 171
handout "The
Hollandaise Family"

■ Method

- (students will have already studied the "Soups, Stocks and Sauces Learning Guide)
- Instructor makes appropriate number of handouts for the class
- Instructor hands out "The Hollandaise Family" sheet and reviews information with the class.

■ Cooking Time

20 minutes

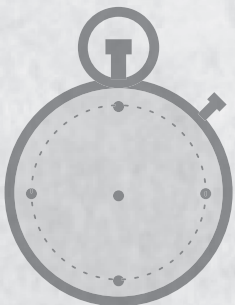

■ Essential Skills being practiced

✓ Document Use

Tip:



THE HOLLANDAISE FAMILY

Warm, emulsified* sauces. Made from egg yolks, warm butter, water, lemon juice or vinegar.

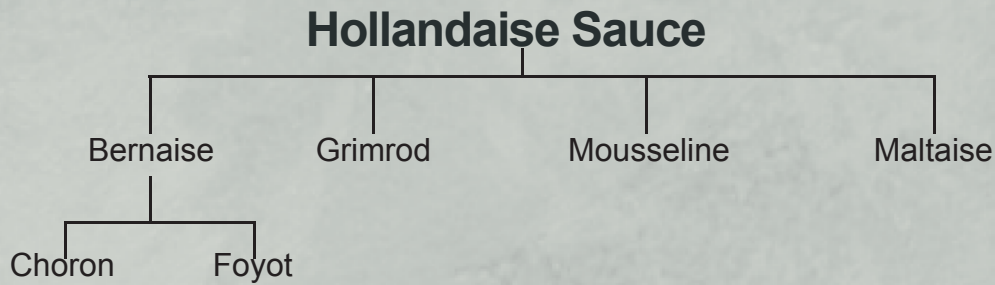

Hollandaise Sauce Derivatives:

- **Grimrod** – infuse a hollandaise sauce reduction with saffron.
- **Mousseline** – (Chantilly Sauce) cream, usually glazed under a broiler
- **Maltaise** – blood orange juice and zest (may also use regular oranges)
- **Bernaise Sauce** – is a Hollandaise with tarragon.

Bernaise Sauce Derivatives:

- **Choron** – tomato puree
- **Foyot** – melted glace de viande

* **emulsification** – the process by which generally unmixable liquids, such as oil and water, are forced into a uniform consistency.



LESSON PLAN - THE TOMATO SAUCE FAMILY

From the kitchen of **SOUP STOCKS & SAUCES**

■ Purpose and Practice:

- To review the information about types of sauces that can be made from Tomato Sauce

■ Ingredients

Page 173
handout "The
Tomato Sauce
Family"

■ Method

- (students will have already studied the "Soups, Stocks and Sauces Learning Guide)
- Instructor makes appropriate number of handouts for the class
- Instructor hands out "The Tomato Sauce Family" and reviews information with the class.

■ Cooking Time

20 minutes



■ Essential Skills being practiced

✓ Document Use

Tip:

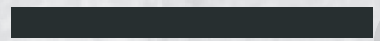

THE TOMATO SAUCE FAMILY

Tomato sauce is made from tomatoes, vegetables, seasonings and white stock. It may or may not be thickened with a roux.

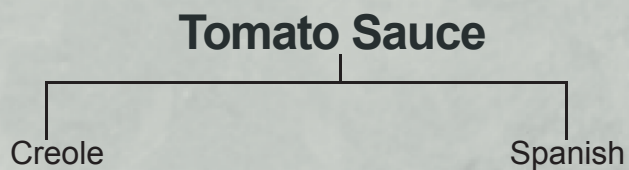

- **Creole:** onion, celery, garlic, bay leaf, thyme, diced green pepper, diced okra, sliced green olives and hot pepper sauce.
- **Spanish:** onions, celery, sweet peppers, garlic, olive oil, mushrooms, chiles, salt and pepper.



LESSON PLAN - THE BECHAMEL FAMILY

From the kitchen of **SOUP STOCKS & SAUCES**

■ Purpose and Practice:

- To review the information about types of derivative sauces that can be made from Bechamel Sauce.

■ Ingredients

Page 175
handout "The
Bechamel Sauce
Family"

■ Method

- (students will have already studied the "Soups, Stocks and Sauces Learning Guide)
- Instructor makes appropriate number of handouts for the class
- Instructor hands out "The Bechamel Sauce Family" and reviews information with the class.

■ Cooking Time

20 minutes

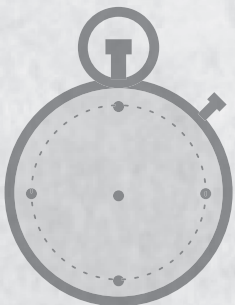

■ Essential Skills being practiced

✓ Document Use

Tip:



THE BÉCHAMEL FAMILY

Named after its creator, Louis de Bechamel (1630 – 1703), béchamel sauce is the easiest basic sauce to prepare. Today, the sauce is made by thickening scalded milk with a white roux and adding seasonings. It is used for vegetable, egg, gratin and pasta dishes.

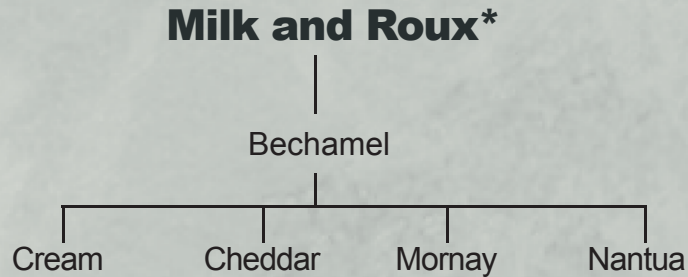

- **Cream Sauce:** scalded cream and a few drops of lemon juice
- **Cheddar:** grated old or medium cheddar cheese, a dash of Tabasco sauce and dry mustard
- **Mornay:** grated gruyere and parmesan cheeses
- **Nantua:** heavy cream, crayfish butter and paprika

**roux – a cooked mixture of equal parts flour and fat by weight; used as a thickener for sauces and other dishes*



VEGETABLES & STARCHES



LESSON PLAN - VEGETABLES - FILL IN THE BLANKS

From the kitchen of **VEGETABLES & STARCHES**

Purpose and Practice:

- Reading material previously studied in class and remembering what was learned

Ingredients

Page 178
(Learners' handout)

-Page 179
(Instructor's answer key)

Method

- Instructor prepares appropriate number of "Vegetables" handouts for the learners
- Individually, learners fill in the blanks using the words provided to complete the passage.
- Instructor reviews the answers with the class in a groups setting.

Cooking Time

15 minutes

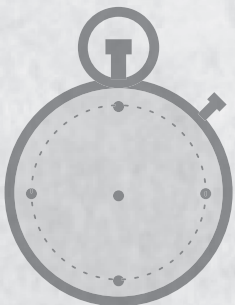

Essential Skills being practiced

- ✓ Thinking Skills
- ✓ Reading Text

Tip:

*(practicing oral communication)
Invite learners to discuss their favourite vegetables and what it is about them that they like (taste, look, aroma, preparation). We normally have difficult eating enough vegetables. Discuss ways to include eating vegetables more often in a daily diet.*

VEGETABLES - EXERCISE

Fill in the blanks by using the best possible word below:



sugar

plant

cooked

savoury*

tissue

eaten

The term vegetable refers to any herbaceous _____ that can be partially or wholly _____. A herbaceous plant has little or no woody _____.

The portion we consume include the leaves, stems, roots, tubers, seeds and flowers.

Vegetables contain more starch and less _____ than fruits. Therefore, vegetables tend to be _____, not sweet. Also, unlike fruits, vegetables are most often eaten _____ not raw.

*savoury = salty

VEGETABLES - ANSWERS

Fill in the blanks by using the best possible word below:



sugar

plant

cooked

savoury*

tissue

eaten

The term vegetable refers to any herbaceous plant that can be partially or wholly eaten. A herbaceous plant has little or no woody tissue.

The portion we consume include the leaves, stems, roots, tubers, seeds and flowers.

Vegetables contain more starch and less sugar than fruits. Therefore, vegetables tend to be savoury, not sweet. Also, unlike fruits, vegetables are most often eaten cooked not raw.

*savoury = salty



**LESSON PLAN - VEGETABLE IDENTIFICATION -
STUDY SHEET & RECALL EXERCISES**

From the kitchen of **VEGETABLES & STARCHES**

■ Purpose and Practice:

- Studying 11 categories of vegetables with examples for each category.
- Reviewing material previously studied in class.

■ Ingredients

Page 181
(learners' handout
study sheet)

Page 182
(learners' practice
sheet – identifying
categories)

Page 183
(learners' practice
sheet – identifying
examples)

■ Method

- Instructor prepares appropriate number of "Vegetable Identification – study sheet" and hands out to learners for review.
- Instructor prepares appropriate number of "Vegetable Identification – Category Identification Exercise" and encourages them to identify the category for each list of examples, without referring to the study sheet.
- Instructor prepares appropriate number of "Vegetable Identification – Example Identification Exercise" and encourages them to write in some examples of vegetables for each category without referring to the study sheet.
- Students check their answers together in smaller groups

■ Cooking Time

30 - 45 minutes

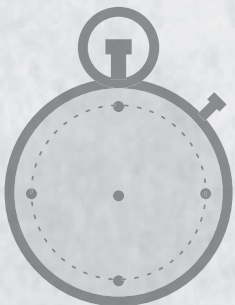

■ Essential Skills being practiced

- ✓ Reading Text
- ✓ Thinking Skills
- ✓ Writing
- ✓ Oral Communication

Tip:

Exercises can be done in small groups or individually.

VEGETABLE IDENTIFICATION - STUDY SHEET

Vegetables are divided into categories. These categories are organized according to which part of the plant is eaten and or used.

Categories	Common Vegetable Examples
Bulbs	onions, shallots, garlic, leeks, scallions
Flower and Buds	bok choy, broccoli, brussels sprouts, cauliflower, green and red cabbage, napa cabbage, savoy cabbage
Fruit Vegetables	avocados, peppers, tomatoes, eggplants, cucumbers, gourds and squashes
Fungus (plural = fungi)	mushrooms (including farmed and wild varieties)
Leafy Greens	spinach, swiss chard, mustard greens
Legumes	green, yellow and dried beans
Pods and Seeds	corn, okra
Roots & Tubers	beets, carrots, parsnips, daikon, turnips, celeriac, jicama, potatoes
Shoots & Stalks	asparagus, celery

VEGETABLE IDENTIFICATION - CATEGORY IDENTIFICATION EXERCISE

Vegetables are divided into categories. These categories are organized according to which part of the plant is eaten and or used. Please list one or two examples of vegetables for each category below:

Categories	Common Vegetable Examples
	onions, shallots, garlic, leeks, scallions
	bok choy, broccoli, brussels sprouts, cauliflower, green and red cabbage, napa cabbage, savoy cabbage
	avocados, peppers, tomatoes, eggplants, cucumbers, gourds and squashes
	mushrooms (including farmed and wild varieties)
	spinach, swiss chard, mustard greens
	green, yellow and dried beans
	corn, okra
	beets, carrots, parsnips, daikon, turnips, celeriac jicama, potatoes
	asparagus, celery

VEGETABLE IDENTIFICATION - EXAMPLE IDENTIFICATION EXERCISE

Vegetables are divided into categories. These categories are organized according to which part of the plant is eaten and or used. Please list one or two examples of vegetables for each category below:

Categories	Common Vegetable Examples
Bulbs	
Flower and Buds	
Fruit Vegetables	
Fungus (plural = fungi)	
Leafy Greens	
Legumes	
Pods and Seeds	
Roots & Tubers	
Shoots & Stalks	



LESSON PLAN - VEGETABLE CATEGORIES - BOOKLET, RECALL BOOKLET & PICTURE MATCH

From the kitchen of **VEGETABLES & STARCHES**

■ Purpose and Practice:

- Studying 11 categories of vegetables with examples, descriptions and images
- Reviewing material previously studied in class.

■ Ingredients

Pages 185 to 194
(learners' handout
booklet)

Pages 195 to 204
(learners' practice
booklet)

Pages 205, 206
(picture match
images)

■ Method

- Instructor prepares appropriate number of "Vegetable Categories" booklets – and hands out to learners for review.
- Instructor prepares appropriate number of "Vegetable Categories - Example Identification Exercise" booklets
- Instructor prepares a number of image cards depending on the size of the group (i.e. 4 sets for groups of 4)
- After learners have had a chance to review, divide the class into small groups and hand out the "Vegetable Categories – Example Identification Exercise" booklets and one set of the image cards
- Working in small groups, learners identify as many examples of vegetables for each category and match images to each example.

■ Cooking Time

60 minutes

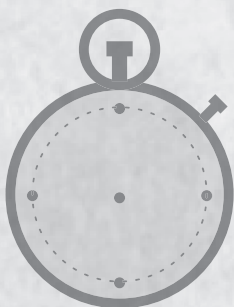

■ Essential Skills being practiced



- ✓ Reading Text
- ✓ Thinking Skills
- ✓ Writing
- ✓ Oral Communication

Tip:





The image cards can be used as a "memory game" by combining 2 sets and flipping them all over (image side) down. Learners take turns flipping 2 cards at a time searching for matches (i.e. cauliflower to cauliflower, bulb onion to bulb onion). Goal is to improve memory recall and collect as many matches as possible.

VEGETABLE CATEGORIES - BULBS





Vegetables are divided into categories. These categories are organized according to which part of the plant is eaten and or used.

Categories	Example	Description	What does it look like?
Bulbs	Bulb Onion	<p>Most widely known bulb.</p> <p>May be white, yellow or red.</p> <p>Choose ones that are firm, dry, and feel heavy.</p>	
	Garlic	<p>One head is made up of many small cloves.</p> <p>Each clove is wrapped in a thin husk or peel; the entire head is encased in several thin layers of papery husk.</p> <p>When using this bulb, remember that the more finely the cloves are crushed, the stronger the flavour will be.</p> <p>Cooking this bulb reduces its pungency and the longer it's cooked, the milder it becomes.</p> <p>Choose firm, dry bulbs with tightly closed cloves and smooth skins.</p>	
	Leeks	<p>Look like large, overgrown scallions (green onions), with a fat white tip and wide green leaves.</p> <p>Their flavour is sweeter and stronger than scallions, but milder than common bulb onions.</p> <p>They must be carefully washed to remove the sandy soil that gets between the leaves.</p>	





VEGETABLE CATEGORIES - FLOWER & BUDS

Categories	Example	Description	What does it look like?
Flower & Buds	Bok Choy	<p>Also known as Pok Choy.</p> <p>It is a white-stemmed kind of southern Chinese cabbage.</p> <p>Choose heads with bright white stalks and dark green leaves.</p>	
	Broccoli	<p>A type of flower with a thick central stalk with greyish-green leaves topped with one or more heads of green florets.</p> <p>Choose firm stalks with compact clusters of tightly closed dark green florets.</p> <p>Avoid stalks with yellow flowers.</p>	
	Brussels Sprouts	<p>The tender young sprouts are similar to baby cabbages and are usually steamed or roasted.</p> <p>Choose small, firm sprouts that are compact and heavy.</p>	
	Green Cabbage	<p>The familiar green ones have large, firm round heads with tightly packed pale green leaves.</p>	





VEGETABLE CATEGORIES - FLOWER & BUDS (CON'T)

Categories	Example	Description	What does it look like?
Flower & Buds	Red Cabbage	Red (or purple) ones are a different strain and may be tougher than the green ones.	
	Cauliflower	The king of the cabbage family. Each stalk produces one flower or head surrounded by large green leaves. The head is composed of creamy white florets. Choose firm, compact heads. Any attached leaves should be bright green and crisp.	
	Napa Cabbage	Also known as Chinese cabbage (suey choy). It has a long head with tightly packed, firm, pale green leaves. It is moister and more tender than common green and red cabbages, with a milder, more delicate flavour.	
	Savoy Cabbage	Has curly, bumpy, wavy, tightly wrinkled leaves. Tends to be milder and more tender than regular cabbages.	

VEGETABLE CATEGORIES - FRUIT VEGETABLES

Categories	Example	Description	What does it look like?
Fruit Vegetables	Avocados	<p>Pear shaped fruits with rich, high-fat flesh.</p> <p>Flesh is golden-green and surrounds a large, inedible, oval-shaped seed (pit).</p> <p>Some varieties have smooth, green skin; others have pebbly, almost black skin.</p>	
	Peppers	<p>Members of the Capsicum family.</p> <p>Include sweet and hot (chiles) varieties.</p> <p>They get their heat from capsaicin, which is found in the placental ribs (not in the flesh or seeds). Its heat can be reduced by carefully removing the ribs and attached seeds. Generally, the smaller the chile, the hotter it is.</p> <p>Common sweet ones are known as “bell”.</p> <p>They are thick-walled fruits available in green, red, yellow, purple, orange and other colours.</p>	
	Tomatoes	<p>Available in a wide variety of colors and shapes.</p> <p>They vary from green (unripe) to golden yellow to ruby red.</p> <p>Size: from tiny spheres to huge, squat ovals (known as beefsteak).</p> <p>Choose fresh ones that are plump with a smooth, shiny skin. The color should be uniform.</p>	
	Eggplant	<p>In French, known as “aubergine” (sounds like oberjeen).</p> <p>Two types commonly available: asian and western.</p> <p>Asian variety is long and thin, with skin colors ranging from creamy white to deep purple.</p>	



VEGETABLE CATEGORIES - FRUIT VEGETABLES (CON'T)

Categories	Example	Description	What does it look like?
Fruit Vegetables	Cucumbers	<p>Common types of “Slicing” ones are: seedless English, Lemon, and the common green field.</p> <p>Choose ones that are firm but not hard. Avoid those that are limp, yellowed or have soft spots.</p>	
	Squashes	<p>Members of the gourd family.</p> <p>They can be classified as winter or summer, based on their peak season and skin.</p> <p>Choose ones with unbroken skins and good colour. Avoid ones with soft, moist spots.</p>	
	Winter Squashes	<p>Varieties include: acorn, banana, butternut, pumpkin and spaghetti.</p> <p>They have hard skins (shells) and seeds.</p> <p>The flesh, which may be removed from the shell before or after cooking tends to be sweeter than the summer squash.</p>	
	Summer Squash	<p>Varieties include the: pattypan, yellow crook-neck and zucchini.</p> <p>They have soft edible skins and seeds that are generally not removed before cooking.</p> <p>Most may be eaten raw, but are also suitable for grilling, sautéing, steaming or baking.</p> <p>Their peak season is April through September.</p>	





VEGETABLE CATEGORIES - FUNGUS (PLURAL = FUNGI)

Categories	Example	Description	What does it look like?
Fungus (plural = fungi)	Mushrooms	<p>Members of a broad category of plants known as fungi.</p> <p>Come in farmed and wild varieties.</p> <p>They have a stalk with an umbrella like top. Even though they aren't really a vegetable, they are used and served in much the same manner as vegetables.</p> <p>Wild ones have a stronger earthy or nutty flavour than the cultivated ones and should generally be cooked before eating.</p> <p>Choose fresh ones that are clean, without soft or moist spots or blemishes.</p>	



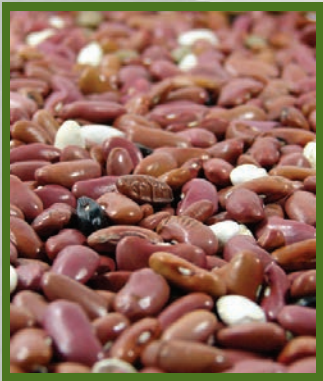

VEGETABLE CATEGORIES - LEAFY GREENS

Categories	Example	Description	What does it look like?
Leafy Greens	Leafy Greens	<p>The term refers to a variety of leafy green vegetables that may be served raw, but are usually cooked.</p> <p>Most have strong, spicy flavours.</p> <p>Mustard, sorrel, spinach, Swiss chard, dandelion and turnip greens fall into this category.</p> <p>Choose young, tender greens with good colour and no limpness. Avoid greens with dry-looking stems or yellow leaves.</p>	
Leafy Greens	Spinach	<p>A versatile green that grows rapidly in cool climates.</p> <p>It has smooth, bright green leaves attached to thin stems.</p> <p>Choose bunches with crisp, tender, deep green leaves; avoid yellow, blemished leaves.</p>	



VEGETABLE CATEGORIES - LEGUMES/PODS AND SEEDS

Categories	Example	Description	What does it look like?
Legumes/ Pods and Seeds	Beans and Peas	Members of the legume family. They have double-seamed pods containing a single row of seeds.	
	Fresh Beans	Commonly referred to as green beans, string beans, runner beans or snap beans. They are picked when they are immature. Except for the stem, the entire pod can be eaten. This category includes the green bean, the yellow wax bean and the French haricot vert. Choose ones that have a bright colour without brown or soft spots. Large pods may be tough or bitter.	
	Dried Beans	Common ones include: kidney, pinto, chickpeas, lentils, black, black-eyed peas and split green peas. Most need to be soaked in water before cooking.	
	Corn	Is actually a grain, a type of grass. They are plant seeds. Choose freshly picked ears with firm, small kernels. Avoid those with mould or decay at the tip of the cob or brownish silks.	

VEGETABLE CATEGORIES - ROOTS AND TUBERS

Categories	Example	Description	What does it look like?
<p>Roots (single roots that extend deep into the soil to supply the above-ground plan with nutrients)</p> <p>and Tubers (fat underground stems)</p>	Beets	<p>Beets can be boiled, then peeled and used in salads, soups or backed dishes.</p> <p>Choose small to medium-sized beets that are firm, with smooth skins.</p> <p>Avoid those with hairy root tips, as they may be tough.</p>	
	Carrots	<p>They are among the most versatile of vegetables. They are large taproots.</p> <p>They are long and pointed with a medium to dark orange colour.</p> <p>They have a mild, sweet flavour.</p> <p>Choose ones that are smooth and well-shaped, with a bright orange colour.</p> <p>If the tops are still attached, they should be fresh-looking and bright green.</p>	
	Parsnips	<p>They are white taproots that look and taste like carrots and have the texture of sweet potatoes.</p> <p>Choose small to medium-sized ones that are firm, smooth and well-shaped.</p> <p>Avoid large, woody ones.</p>	
	Rutabagas	<p>They are a root vegetable and a member of the cabbage family. Their skin is purple to yellow and they have yellow flesh with a distinctive starchy, cabbage-like flavour.</p> <p>Choose small to medium-sized ones that are smooth and firm and feel heavy.</p>	
	Turnips	<p>They are a root vegetable from the cabbage family.</p> <p>They have white skin with a rosy-re or purple blush and white interior.</p> <p>Flavour is similar to a radish.</p> <p>Choose small to medium-sized turnips that have smooth skin and feel heavy.</p> <p>They should be firm, not rubbery or limp.</p>	

VEGETABLE CATEGORIES - SHOOTS AND STALKS

Categories	Example	Description	What does it look like?
<p>Shoots and Stalks (plant stems with a high percentage of cellulose fibre)</p>	<p>Asparagus</p>	<p>Generally has bright green shoots with a ruffle of tiny leaves at the tip.</p> <p>Larger spears or shoots tend to be tough and woody but can be used in soups or for puree.</p> <p>Choose firm, plump spears with tightly closed tips and a bright green colour running the full length of the spear.</p> <p>White ones are sometimes available fresh.</p>	
	<p>Celery</p>	<p>The stalk variety is pale green with stringy curved stalks (ribs).</p> <p>Choose stalks that are crisp, without any sign of dryness.</p> <p>Available all year.</p>	

VEGETABLE CATEGORIES - EXAMPLE IDENTIFICATION EXERCISE

Vegetables are divided into categories. These categories are organized according to which part of the plant is eaten and or used.

Categories	Example	Description
Bulbs		<p>Most widely known bulb.</p> <p>May be white, yellow or red.</p> <p>Choose ones that are firm, dry, and feel heavy.</p>
		<p>One head is made up of many small cloves.</p> <p>Each clove is wrapped in a thin husk or peel; the entire head is encased in several thin layers of papery husk.</p> <p>When using this bulb, remember that the more finely the cloves are crushed, the stronger the flavour will be.</p> <p>Cooking this bulb reduces its pungency and the longer it's cooked, the milder it becomes.</p> <p>Choose firm, dry bulbs with tightly closed cloves and smooth skins.</p>
		<p>Look like large, overgrown scallions (green onions), with a fat white tip and wide green leaves.</p> <p>Their flavour is sweeter and stronger than scallions, but milder than common bulb onions.</p> <p>They must be carefully washed to remove the sandy soil that gets between the leaves.</p>

VEGETABLE CATEGORIES - EXAMPLE IDENTIFICATION EXERCISE

Categories	Example	Description
Flower & Buds		<p>Also known as Pok Choy.</p> <p>It is a white-stemmed kind of southern Chinese cabbage.</p> <p>Choose heads with bright white stalks and dark green leaves.</p>
		<p>A type of flower with a thick central stalk with greyish-green leaves topped with one or more heads of green florets.</p> <p>Choose firm stalks with compact clusters of tightly closed dark green florets.</p> <p>Avoid stalks with yellow flowers.</p>
		<p>The tender young sprouts are similar to baby cabbages and are usually steamed or roasted.</p> <p>Choose small, firm sprouts that are compact and heavy.</p>
		<p>The familiar green ones have large, firm round heads with tightly packed pale green leaves.</p>

VEGETABLE CATEGORIES - EXAMPLE IDENTIFICATION EXERCISE

Categories	Example	Description
Flower & Buds		Red (or purple) ones are a different strain and may be tougher than the green ones.
		The king of the cabbage family. Each stalk produces one flower or head surrounded by large green leaves. The head is composed of creamy white florets. Choose firm, compact heads. Any attached leaves should be bright green and crisp.
		Also known as Chinese cabbage (suey choy). It has a long head with tightly packed, firm, pale green leaves. It is moister and more tender than common green and red cabbages, with a milder, more delicate flavour.
		Has curly, bumpy, wavy, tightly wrinkled leaves. Tends to be milder and more tender than regular cabbages.

VEGETABLE CATEGORIES - EXAMPLE IDENTIFICATION EXERCISE

Categories	Example	Description
Fruit Vegetables		<p>Pear shaped fruits with rich, high-fat flesh.</p> <p>Flesh is golden-green and surrounds a large, inedible, oval-shaped seed (pit).</p> <p>Some varieties have smooth, green skin; others have pebbly, almost black skin.</p>
		<p>Members of the Capsicum family.</p> <p>Include sweet and hot (chiles) varieties.</p> <p>They get their heat from capsaicin, which is found in the placental ribs (not in the flesh or seeds). Its heat can be reduced by carefully removing the ribs and attached seeds. Generally, the smaller the chile, the hotter it is.</p> <p>Common sweet ones are known as “bell”. They are thick-walled fruits available in green, red, yellow, purple, orange and other colours.</p>
		<p>Available in a wide variety of colors and shapes.</p> <p>They vary from green (unripe) to golden yellow to ruby red.</p> <p>Size: from tiny spheres to huge, squat ovals (known as beefsteak).</p> <p>Choose fresh ones that are plump with a smooth, shiny skin. The color should be uniform.</p>
		<p>In French, known as “aubergine” (sounds like oberjeen).</p> <p>Two types commonly available: asian and western.</p> <p>Asian variety is long and thin, with skin colors ranging from creamy white to deep purple.</p>

VEGETABLE CATEGORIES - EXAMPLE IDENTIFICATION EXERCISE

Categories	Example	Description
Fruit Vegetables		<p>Common types of "Slicing" ones are: seedless English, Lemon, and the common green field.</p> <p>Choose ones that are firm but not hard. Avoid those that are limp, yellowed or have soft spots.</p>
		<p>Members of the gourd family.</p> <p>They can be classified as winter or summer, based on their peak season and skin.</p> <p>Choose ones with unbroken skins and good colour. Avoid ones with soft, moist spots.</p>
		<p>Varieties include: acorn, banana, butternut, pumpkin and spaghetti.</p> <p>They have hard skins (shells) and seeds.</p> <p>The flesh, which may be removed from the shell before or after cooking tends to be sweeter than the summer squash.</p>
		<p>Varieties include the: pattypan, yellow crookneck and zucchini.</p> <p>They have soft edible skins and seeds that are generally not removed before cooking.</p> <p>Most may be eaten raw, but are also suitable for grilling, sautéing, steaming or baking.</p> <p>Their peak season is April through September.</p>

VEGETABLE CATEGORIES - EXAMPLE IDENTIFICATION EXERCISE

Categories	Example	Description
Fungus (plural = fungi)		<p>Members of a broad category of plants known as fungi.</p> <p>Come in farmed and wild varieties.</p> <p>They have a stalk with an umbrella like top. Even though they aren't really a vegetable, they are used and served in much the same manner as vegetables.</p> <p>Wild ones have a stronger earthy or nutty flavour than the cultivated ones and should generally be cooked before eating.</p> <p>Choose fresh ones that are clean, without soft or moist spots or blemishes.</p>

VEGETABLE CATEGORIES - EXAMPLE IDENTIFICATION EXERCISE

Categories	Example	Description
Leafy Greens		<p>The term refers to a variety of leafy green vegetables that may be served raw, but are usually cooked.</p> <p>Most have strong, spicy flavours.</p> <p>Mustard, sorrel, spinach, Swiss chard, dandelion and turnip greens fall into this category.</p> <p>Choose young, tender greens with good colour and no limpness. Avoid greens with dry-looking stems or yellow leaves.</p>
Leafy Greens		<p>A versatile green that grows rapidly in cool climates.</p> <p>It has smooth, bright green leaves attached to thin stems.</p> <p>Choose bunches with crisp, tender, deep green leaves; avoid yellow, blemished leaves.</p>

VEGETABLE CATEGORIES - EXAMPLE IDENTIFICATION EXERCISE

Categories	Example	Description
Legumes/ Pods and Seeds		<p>Members of the legume family.</p> <p>They have double-seamed pods containing a single row of seeds.</p>
		<p>Commonly referred to as green beans, string beans, runner beans or snap beans.</p> <p>They are picked when they are immature.</p> <p>Except for the stem, the entire pod can be eaten.</p> <p>This category includes the green bean, the yellow wax bean and the French haricot vert.</p> <p>Choose ones that have a bright colour without brown or soft spots.</p> <p>Large pods may be tough or bitter.</p>
		<p>Common ones include: kidney, pinto, chickpeas, lentils, black, black-eyed peas and split green peas.</p> <p>Most need to be soaked in water before cooking.</p>
		<p>Is actually a grain, a type of grass.</p> <p>They are plant seeds.</p> <p>Choose freshly picked ears with firm, small kernels.</p> <p>Avoid those with mould or decay at the tip of the cob or brownish silks.</p>

VEGETABLE CATEGORIES - EXAMPLE IDENTIFICATION EXERCISE

Categories	Example	Description
<p>Roots (single roots that extend deep into the soil to supply the above-ground plan with nutrients)</p> <p>and</p> <p>Tubers (fat underground stems)</p>		<p>Beets can be boiled, then peeled and used in salads, soups or backed dishes.</p> <p>Choose small to medium-sized beets that are firm, with smooth skins.</p> <p>Avoid those with hairy root tips, as they may be tough.</p>
		<p>They are among the most versatile of vegetables. They are large taproots.</p> <p>They are long and pointed with a medium to dark orange colour.</p> <p>They have a mild, sweet flavour.</p> <p>Choose ones that are smooth and well- shaped, with a bright orange colour.</p> <p>If the tops are still attached, they should be fresh-looking and bright green.</p>
		<p>They are white taproots that look and taste like carrots and have the texture of sweet potatoes.</p> <p>Choose small to medium-sized ones that are firm, smooth and well-shaped.</p> <p>Avoid large, woody ones.</p>
		<p>They are a root vegetable and a member of the cabbage family. Their skin is purple to yellow and they have yellow flesh with a distinctive starchy, cabbage-like flavour.</p> <p>Choose small to medium-sized ones that are smooth and firm and feel heavy.</p>
		<p>They are a root vegetable from the cabbage family.</p> <p>They have white skin with a rosy-re or purple blush and white interior.</p> <p>Flavour is similar to a radish.</p> <p>Choose small to medium-sized turnips that have smooth skin and feel heavy.</p> <p>They should be firm, not rubbery or limp.</p>

VEGETABLE CATEGORIES - EXAMPLE IDENTIFICATION EXERCISE

Categories	Example	Description
<p>Shoots and Stalks (plant stems with a high percentage of cellulose fibre)</p>		<p>Generally has bright green shoots with a ruffle of tiny leaves at the tip.</p> <p>Larger spears or shoots tend to be tough and woody but can be used in soups or for puree.</p> <p>Choose firm, plump spears with tightly closed tips and a bright green colour running the full length of the spear.</p> <p>White ones are sometimes available fresh.</p>
		<p>The stalk variety is pale green with stringy curved stalks (ribs).</p> <p>Choose stalks that are crisp, without any sign of dryness.</p> <p>Available all year.</p>

VEGETABLE CATEGORIES - IMAGE CUT OUTS







LESSON PLAN - GUIDELINES FOR VEGETABLE COOKERY

From the kitchen of **VEGETABLES & STARCHES**

■ Purpose and Practice:

- Review 6 general guidelines for cooking vegetables that should be considered regardless of the cooking method used.
- Matching phrases to form a complete thought.

■ Ingredients

Page 208
Guidelines for
Vegetable Cookery
handout

Pages 209 - 210
Guidelines for
Vegetable Cookery
Phrase Match
Exercise A,B

■ Method

- Instructor prepares appropriate number of "Guidelines for Vegetable Cookery" handout and reviews with the class
- Instructor prepares 4 sets of phrase match strips (color coded) by cutting along the dotted lines and separating into sets. Instructor shuffles the strips of the same color so that they are not in order.
- Distribute a complete (shuffled) set to each group (2 to 5 students per group)
- Invite each group to work together (encouraging total participation) to match up phrases to make up a complete thought/guideline.
- Come together as a whole class to review the sort.

■ Cooking Time

30 minutes

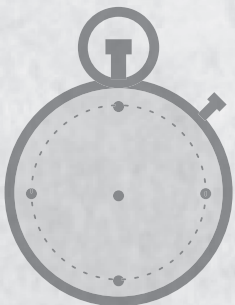

■ Essential Skills being practiced

- ✓ Thinking Skills
- ✓ Working With Others
- ✓ Document Use
- ✓ Reading Text

Tip:

If learners are struggling to make a match, remind them to use Thinking Skills and search for clues that would suggest a perfect match.

GUIDELINES FOR VEGETABLE COOKERY

The following general guidelines for vegetable cookery should be considered regardless of the cooking method used:

1. Vegetables should be carefully cut into uniform shapes and sizes to promote even cooking and provide an attractive finished product.
2. Cook vegetables for as short a time as possible to preserve texture, colour and nutrients.
3. Cook vegetables as close to service time as possible. Holding vegetables in a steam table continues to cook them.
4. When necessary, vegetables may be blanched in advance, refreshed in ice water and refrigerated. They can then be reheated as needed.
5. White and red vegetables (those with flavonoid pigments) may be cooked with a small amount of acid such as lemon juice, vinegar or white wine to help retain their color.
6. When preparing an assortment of vegetables, cook each type separately, and then combine them. Otherwise some items will be overcooked in the time required to cook others properly.

GUIDELINES FOR VEGETABLE COOKERY - PHRASE MATCH EXERCISE A

Match the best possible phrases/sentences to each other:

Vegetables should be carefully cut into uniform shapes and sizes

to promote even cooking and provide an attractive finished product.

Cook vegetables for as short a time as possible

to preserve texture, colour and nutrients.

Cook vegetables as close to service time as possible.

Holding vegetables in a steam table continues to cook them.

GUIDELINES FOR VEGETABLE COOKERY - PHRASE MATCH EXERCISE B

Match the best possible phrases/sentences to each other:

When necessary, vegetables may be blanched in advance,

refreshed in ice water and refrigerated.

White and red vegetables (those with flavonoid pigments) may be cooked with a small

amount of acid such as lemon juice, vinegar or white wine to help retain their color.

When preparing an assortment of vegetables,

cook each type separately, and then combine them.



LESSON PLAN - PURCHASING & STORING FRESH VEGETABLES – FILL IN THE BLANKS

From the kitchen of **VEGETABLES & STARCHES**

■ Purpose and Practice:

- Reading material previously studied in class and remembering what was learned

■ Ingredients

Page 212
(Learners' handout)

Page 213
(Instructor's answer key)

■ Method

- Instructor prepares appropriate number of "Purchasing and Storing Fresh Vegetables" handouts for the learners
- Individually, learners fill in the blanks using the words provided to complete the passage.
- Instructor reviews the answers with the class in a groups setting.

■ Cooking Time

15 minutes

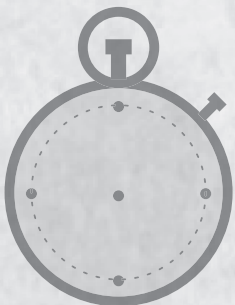

■ Essential Skills being practiced

- ✓ Thinking Skills
- ✓ Reading Text

Tip:

Invite learners to discuss the idea of spoilage. Questions to ask: how many of you buy fresh vegetables only to have to throw them out because they are spoiled? What do you do to make sure that you use any vegetables that you bring home?

PURCHASING AND STORING FRESH VEGETABLES - EXERCISE

Fill in the blanks by using the best possible word below:

greatest**seasonal****vegetables****advantages****texture****lowest**

Fresh _____ should be selected according to _____ availability. Using a vegetable at the peak of its season has several _____: Price is at its _____, selection is at its _____ and the vegetable's color, flavour and _____ are at their best.

PURCHASING AND STORING FRESH VEGETABLES - ANSWERS

Fill in the blanks by using the best possible word below:

greatest

seasonal

vegetables

advantages

texture

lowest

Fresh vegetables should be selected according to

seasonal availability. Using a vegetable at the peak of its season

has several advantages: Price is at its lowest,

selection is at its greatest and the vegetable's color, flavour and

texture are at their best.



**LESSON PLAN - DETERMINING DONENESS –
FILL IN THE BLANKS**

From the kitchen of **VEGETABLES & STARCHES**

■ Purpose and Practice:

- Reading material previously studied in class and remembering what was learned.

■ Ingredients

Page 215
(Learners' handout)

Page 216
(Instructor's answer
key)

■ Method

- Instructor prepares appropriate number of "Determining Doneness" handouts for the learners
- Individually, learners fill in the blanks using the words provided to complete the passage.
- Instructor reviews the answers with the class in a groups setting.

■ Cooking Time

15 minutes

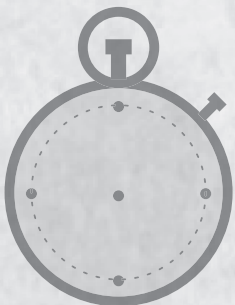

■ Essential Skills being practiced

- ✓ Thinking Skills
- ✓ Reading Text

Tip:

(practicing oral communication)

Invite learners to discuss the idea of overcooking vegetables: What happens when vegetables are overcooked? How do you cook vegetables at home? What kinds of vegetables do you enjoy eating raw?

DETERMINING DONENESS - EXERCISE

Fill in the blanks by using the best possible word below:

bright**pierced****aroma****paring****wilted****overcooking**

Most cooked vegetables are done when they are just tender when _____
with a fork or the tip of a _____ knife. Leafy vegetables should be
_____ but still have a _____ color.

You can avoid _____ vegetables by remembering that some
carryover cooking will occur. Always rely on objective tests – sight, taste and
_____ rather than the clock.

DETERMINING DONENESS - ANSWERS

Fill in the blanks by using the best possible word below:

bright**pierced****aroma****paring****wilted****overcooking**

Most cooked vegetables are done when they are just tender when **pierced**

with a fork or the tip of a **paring** knife. Leafy vegetables should be

 wilted but still have a **bright** color.

You can avoid **overcooking** vegetables by remembering that some

carryover cooking will occur. Always rely on objective tests – sight, taste and

 aroma rather than the clock.



LESSON PLAN - STARCHES - STUDY SHEETS

From the kitchen of **VEGETABLES & STARCHES**

Purpose and Practice:

- Study sheet hand out of starches with pictures and definitions.

Ingredients

Pages 218 to 221
 Study Sheets
 (part A and B) -
 foundation for
 other exercises –
 handout

Method

- Instructor makes appropriate number of handouts for the class
- Instructor hands out ``Study Sheets`` sheet for the students to use as a reference.
- Instructor reviews the information with the class.

Cooking Time

20 minutes



Essential Skills being practiced

- ✓ Document Use
- ✓ Thinking Skills
- ✓ Reading skills

Tip:

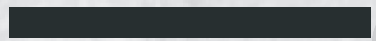

STARCHES - STUDY SHEET - A**Red Potatoes**

Have a thin red skin and crisp, white, waxy flesh best suited to boiling or steaming. They do not have the dry, mealy texture successful baking requires.

**Russet**

Also referred to as Idaho Potatoes, are the standard baking potatoes. Russets are excellent baked and are the best potatoes for frying.

**Sweet Potatoes**

Sweet potatoes are from a different botanical family than ordinary potatoes. Two types are commonly available. One has a yellow flesh and a dry mealy texture white sweet potato. The other has a darker orange, moister flesh and is high in sugar.

**Yams**

Botanically different from both sweet and common potatoes, Yams are less sweet than sweet potatoes. Flesh of yams changes from creamy white to deep red.

STARCHES - STUDY SHEET - B**Converted rice**

Is Parboiled to remove the surface starch. This procedure also forces nutrients from the bran into the endosperm. Therefore, converted rice retains more nutrients than the regular milled white rice, although the flavour is the same.

**Arborio rice**

Is a round, short grained rice used primarily in Italian dishes such as risotto. It is very sticky, with a white color and mild flavour.

**Basmati Rice**

Is one of the finest long grained rice in the world. It grows in the Himalayan foothills and is preferred in Indian cuisine. Jasmine rice another aromatic long grain rice. It is grown in Thailand.

**Brown Rice**

Is the whole natural grain of rice. Brown rice has a nutty flavour; its chewy texture is caused by the high fibre bran. Brown rice absorbs more water and takes longer to cook than white rice does.

**Wild Rice**

Is prepared in the same manner as traditional rice, although it is actually the seed of an unrelated reed like aquatic plant.



LESSON PLAN - STARCHES - PICTURE MATCH

From the kitchen of **VEGETABLES & STARCHES**

Purpose and Practice:

- Match the pictures of the starches with the starches description.

Ingredients

Page 221, 222

Match the picture to definition

Method

- Instructor makes appropriate number of handouts for the class
- Instructor hands out ``Picture Match A and B sets`` for the students to use as a reference. There are four sets of picture and definitions.
- Students will be split up into groups and work together to match the pictures to the description that is provided.
- Come together as a class to go over the activity.

Cooking Time

30 minutes

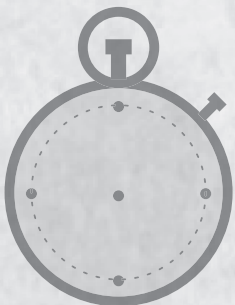

Essential Skills being practiced

- ✓ Document Use
- ✓ Thinking Skills
- ✓ Reading skills

Tip:



STARCHES - PICTURE MATCH - A

**Red Potatoes**

Have a thin red skin and crisp, white, waxy flesh best suited to boiling or steaming. They do not have the dry, mealy texture successful baking requires.

**Russet**

Also referred to as Idaho Potatoes, are the standard baking potatoes. Russets are excellent baked and are the best potatoes for frying.

**Sweet Potatoes**

Sweet potatoes are from a different botanical family than ordinary potatoes. Two types are commonly available. One has a yellow flesh and a dry mealy texture white sweet potato. The other has a darker orange, moister flesh and is high in sugar.

**Yams**

Botanically different from both sweet and common potatoes, Yams are less sweet than sweet potatoes. Flesh of yams changes from creamy white to deep red.

STARCHES - PICTURE MATCH - B

**Converted rice**

Is Parboiled to remove the surface starch. This procedure also forces nutrients from the bran into the endosperm. Therefore, converted rice retains more nutrients than the regular milled white rice, although the flavour is the same.

**Arborio rice**

Is a round, short grained rice used primarily in Italian dishes such as risotto. It is very sticky, with a white color and mild flavour.

**Basmati Rice**

Is one of the finest long grained rice in the world. It grows in the Himalayan foothills and is preferred in Indian cuisine. Jasmine rice another aromatic long grain rice. It is grown in Thailand.

**Brown Rice**

Is the whole natural grain of rice. Brown rice has a nutty flavour; its chewy texture is caused by the high fibre bran. Brown rice absorbs more water and takes longer to cook than white rice does.

**Wild Rice**

Is prepared in the same manner as traditional rice, although it is actually the seed of an unrelated reed like aquatic plant.



LESSON PLAN - STARCHES - DEFINITION MATCH

From the kitchen of **VEGETABLES & STARCHES**

■ Purpose and Practice:

- To match the definitions with the appropriate Starch.

■ Ingredients

Page 224
Definition Match

Page 225
Definition Match
Answer Key

■ Method

- Instructor makes appropriate number of the definition match handouts for the class
- Instructor hands out ``Definition Match`` sheet for the students to use.
- Students will take the sheets provided and add the names of the starches to description that is provided.
- Come together as a class to go over the activity.

■ Cooking Time

30 minutes

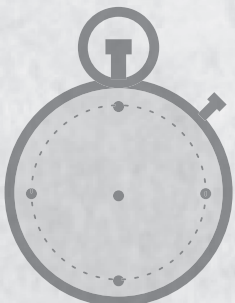

■ Essential Skills being practiced

- ✓ Document Use
- ✓ Thinking Skills
- ✓ Reading skills

Tip:

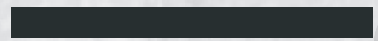

STARCHES - DEFINITION MATCH

Write the name of the starch above the definition

- A. _____
Botanically different from both sweet and common potatoes. They are less sweet than sweet potatoes. Flesh changes from creamy white to deep red.
- B. _____
Is the whole natural grain of rice. This rice has a nutty flavour; its chewy texture is caused by the high fibre bran. Absorbs more water and takes longer to cook than white rice does.
- C. _____
Is parboiled to remove the surface starch. This procedure also forces nutrients from the bran into the endosperm. Therefore, this rice retains more nutrients than the regular milled white rice, although the flavour is the same.
- D. _____
One of the finest long grained rice in the world. It grows in the Himalayan foothills and is preferred in Indian cuisine. It is highly aromatic, with a sweet, delicate flavour and a creamy color. It is grown in Thailand.
- E. _____
This rice is prepared in the same manner as traditional rice, although it is actually the seed of an unrelated reed like aquatic plant.
- F. _____
These potatoes have a thin red skin and crisp, white, waxy flesh best suited to boiling or steaming they do not have the dry, mealy texture successful baking requires.
- G. _____
This rice is a round, short grained rice used primarily in Italian dishes such as risotto. It is very sticky, with a white color and mild flavour.
- H. _____
Also referred to as Idaho Potatoes, are the standard baking potatoes. They are excellent baked and are the best potatoes for frying.
- I. _____
From a different botanical family than ordinary potatoes. Two types are commonly available. One has a yellow flesh and a dry mealy texture white sweet potato. The other has a darker orange, moister flesh and is high in sugar.

STARCHES - DEFINITION MATCH - ANSWERS

Write the name of the starch above the definition

- A. **Yams**
Botanically different from both sweet and common potatoes. They are less sweet than sweet potatoes. Flesh changes from creamy white to deep red.
- B. **Wild Rice**
Is the whole natural grain of rice. This rice has a nutty flavour; its chewy texture is caused by the high fibre bran. Absorbs more water and takes longer to cook than white rice does.
- C. **Converted Rice**
Is parboiled to remove the surface starch. This procedure also forces nutrients from the bran into the endosperm. Therefore, this rice retains more nutrients than the regular milled white rice, although the flavour is the same.
- D. **Basmati Rice**
One of the finest long grained rice in the world. It grows in the Himalayan foothills and is preferred in Indian cuisine. It is highly aromatic, with a sweet, delicate flavour and a creamy color. It is grown in Thailand.
- E. **Wild Rice**
This rice is prepared in the same manner as traditional rice, although it is actually the seed of an unrelated reed like aquatic plant.
- F. **Red Potatoes**
These potatoes have a thin red skin and crisp, white, waxy flesh best suited to boiling or steaming they do not have the dry, mealy texture successful baking requires.
- G. **Arborio Rice**
This rice is a round, short grained rice used primarily in Italian dishes such as risotto. It is very sticky, with a white color and mild flavour.
- H. **Russet Potatoes**
Also referred to as Idaho Potatoes, are the standard baking potatoes. They are excellent baked and are the best potatoes for frying.
- I. **Sweet potatoes**
From a different botanical family than ordinary potatoes. Two types are commonly available. One has a yellow flesh and a dry mealy texture white sweet potato. The other has a darker orange, moister flesh and is high in sugar.



LESSON PLAN - STARCHES - WORD SCRABBLE EXERCISE

From the kitchen of VEGETABLES & STARCHES

Purpose and Practice:

- To become more familiar with the words and definitions of starches.

Ingredients

Page 227
Word Scrabble
Exercise

Page 228
Word Scrabble
Exercise Answer
Key

Method

- Instructor makes appropriate number of the Word Scramble handouts for the class
- Instructor hands out "Word Scramble Exercise" sheet for the students to use.
- Students will look at the words that are mixed up on the handout and using the definitions provided unscramble the words and write on the line above the definition provided.
- Come together as a class to go over the activity with instructors answer key.

Cooking Time

30 minutes



Essential Skills being practiced

- ✓ Document Use
- ✓ Thinking Skills
- ✓ Reading skills

Tip: [Redacted]

STARCHES - WORD SCRABBLE EXERCISE

Match the definition to the mixed up word and correctly spell

Nbwon cire

dwli icer

tamsabi crie

obraori ider

tordevcen

icer myas

tospaeot tewse

poteoats setrus

atpeotos erd

- A. _____
This rice is prepared in the same manner as traditional rice, although it is actually the seed of an unrelated reed like aquatic plant.
- B. _____
Botanically different from both sweet and common potatoes. They are less sweet than sweet potatoes. Flesh changes from creamy white to deep red.
- C. _____
Is the whole natural grain of rice. This rice has a nutty flavour; its chewy texture is caused by the high fibre bran. Absorbs more water and takes longer to cook than white rice does.
- D. _____
These potatoes have a thin red skin and crisp, white, waxy flesh best suited to boiling or steaming they do not have the dry, mealy texture successful baking requires.
- E. _____
This rice is a round, short grained rice used primarily in Italian dishes such as risotto. It is very sticky, with a white color and mild flavour.
- F. _____
Is parboiled to remove the surface starch. This procedure also forces nutrients from the bran into the endosperm. Therefore, this rice retains more nutrients than the regular milled white rice, although the flavour is the same.
- G. _____
From a different botanical family than ordinary potatoes. Two types are commonly available. One has a yellow flesh and a dry mealy texture white sweet potato. The other has a darker orange, moister flesh and is high in sugar.
- H. _____
One of the finest long grained rice in the world. It grows in the Himalayan foothills and is preferred in Indian cuisine. It is highly aromatic, with a sweet, delicate flavour and a creamy color. It is grown in Thailand.
- I. _____
Also referred to as Idaho Potatoes, are the standard baking potatoes. They are excellent baked and are the best potatoes for frying.

STARCHES - WORD SCRABBLE EXERCISE - ANSWERS

Match the definition to the mixed up word and correctly spell

Nbwon cire

dwli icer

tamsabi crie

obraori ider

tordevcen

icer myas

tospaeot tewse

poteoats setrus

atpeotos erd

- A. **Wild Rice**
This rice is prepared in the same manner as traditional rice, although it is actually the seed of an unrelated reed like aquatic plant.
- B. **Yams**
Botanically different from both sweet and common potatoes. They are less sweet than sweet potatoes. Flesh changes from creamy white to deep red.
- C. **Brown Rice**
Is the whole natural grain of rice. This rice has a nutty flavour; its chewy texture is caused by the high fibre bran. Absorbs more water and takes longer to cook than white rice does.
- D. **Red Potatoes**
These potatoes have a thin red skin and crisp, white, waxy flesh best suited to boiling or steaming they do not have the dry, mealy texture successful baking requires.
- E. **Arborio Rice**
This rice is a round, short grained rice used primarily in Italian dishes such as risotto. It is very sticky, with a white color and mild flavour.
- F. **Converted Rice**
Is parboiled to remove the surface starch. This procedure also forces nutrients from the bran into the endosperm. Therefore, this rice retains more nutrients than the regular milled white rice, although the flavour is the same.
- G. **Sweet Potatoes**
From a different botanical family than ordinary potatoes. Two types are commonly available. One has a yellow flesh and a dry mealy texture white sweet potato. The other has a darker orange, moister flesh and is high in sugar.
- H. **Basmati Rice**
One of the finest long grained rice in the world. It grows in the Himalayan foothills and is preferred in Indian cuisine. It is highly aromatic, with a sweet, delicate flavour and a creamy color. It is grown in Thailand.
- I. **Russet Potatoes**
Also referred to as Idaho Potatoes, are the standard baking potatoes. They are excellent baked and are the best potatoes for frying.



LESSON PLAN - STARCHES - WHEAT

From the kitchen of **VEGETABLES & STARCHES**

■ Purpose and Practice:

- Reading and comprehension exercise.

■ Ingredients

Page 230
Reading Passage
with questions
exercise

Page 231
Answer Key

■ Method

- Instructor makes appropriate number of the Wheat handouts for the class
- Instructor hands out `` Reading and Comprehension Exercise `` sheet for the students to use.
- Students will read the information that is provided and answer the questions at the bottom of the page.
- Come together as a class to go over the activity with instructors answer key.

■ Cooking Time

30 minutes

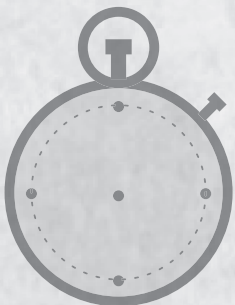

■ Essential Skills being practiced

- ✓ Document Use
- ✓ Thinking Skills
- ✓ Reading skills

Tip:

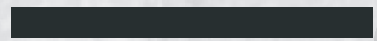

WHEAT - READING AND COMPREHENSION EXERCISE

Wheat is most often milled into the wide range of flours. Wheat and wheat products derived from it are also used as starchy side dishes or ingredients in soups, salads, ground meat dishes and breads. These products include cracked wheat, bulgur, and couscous.

Cracked Wheat – is the whole wheat kernel broken into various degrees of coarseness. Cracked wheat can be cooked by long gentle simmering.

Barley - Is one of the oldest culinary grains, used by humans since prehistoric times. The most common type is pearled to produce small, round white nugget of endosperm. It has a sweet earthy flavour similar to oats. Its starchiness can be used to thicken soups or stews.

Oats – After rice, oats are probably the most widely accepted whole grain product in the North America diet. Oats are consumed daily as a hot breakfast cereal. It is used in breads muffins cookies and other baked goods

STORING – all grains should be stored in an airtight containers placed in a dark, cool, dry place. Airtight containers prevent dust and insects from entering. Airtight containers and darkness also reduce nutrient loss.

Instructions:

Read the passage about wheat and using that information, answer the questions below.

1. What is one of the most widely accepted whole grains in North America?

2. What do air tight containers prevent?

3. How do you reduce nutrient loss in grains?

4. Due to its starchiness what can barley be used for?

5. What is one way to cook cracked wheat?

6. Wheat is used as an ingredient in what types of foods?

WHEAT - READING AND COMPREHENSION EXERCISE - ANSWERS

Wheat is most often milled into the wide range of flours. Wheat and wheat products derived from it are also used as starchy side dishes or ingredients in soups, salads, ground meat dishes and breads. These products include cracked wheat, bulgur, and couscous.

Cracked Wheat – is the whole wheat kernel broken into various degrees of coarseness. Cracked wheat can be cooked by long gentle simmering.

Barley - Is one of the oldest culinary grains, used by humans since prehistoric times. The most common type is pearled to produce small, round white nugget of endosperm. It has a sweet earthy flavour similar to oats. Its starchiness can be used to thicken soups or stews.

Oats – After rice, oats are probably the most widely accepted whole grain product in the North America diet. Oats are consumed daily as a hot breakfast cereal. It is used in breads muffins cookies and other baked goods

STORING – all grains should be stored in an airtight containers placed in a dark, cool, dry place. Airtight containers prevent dust and insects from entering. Airtight containers and darkness also reduce nutrient loss.

Instructions:

Read the passage about wheat and using that information, answer the questions below.

1. What is one of the most widely accepted whole grains in North America?

Oats

2. What do air tight containers prevent?

Airtight containers prevent dust and insects from entering

3. How do you reduce nutrient loss in grains?

Airtight containers and darkness reduce nutrient loss.

4. Due to its starchiness what can barley be used for?

Can be used to thicken soups or stews.

5. What is one way to cook cracked wheat?

Cracked wheat can be cooked by long gentle simmering.

6. Wheat is used as an ingredient in what types of foods?

Can be used as ingredients in soups, salads, ground meat dishes and breads.



LESSON PLAN - STARCHES WORD SEARCH

From the kitchen of **VEGETABLES & STARCHES**

■ Purpose and Practice:

- To work on the words in the vegetable and starches module.

■ Ingredients

Page 233
Word Search
Exercise

Page 234
Word Search
Answer Key

■ Method

- Instructor makes appropriate number of the word search handouts for the class
- Instructor hands out `` Word Search Exercise `` sheet for the students to use.
- Students will use the words on the bottom of the page and find those words in the word search above.
- Come together as a class to go over the activity with instructors answer key.

■ Cooking Time

30 minutes

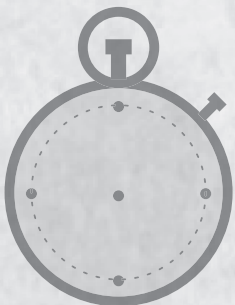

■ Essential Skills being practiced

- ✓ Document Use
- ✓ Thinking Skills
- ✓ Reading skills

Tip:



STARCHES WORD SEARCH

s t o r i n g b i o a u
 e i s u o o w m t e o r
 o t r o h s e e c e i m
 t a e h w d e k c a r c
 a m r s i w e k g o o y
 t s o u s y e l r a b a
 o a m e c u o c a t r m
 p b r o w n r a i s a s
 e e r i g i t o n r m s
 d n l d d r t e t o d i
 b d l r c r b u i s u m
 e t s r o s o i t d a e

cracked wheat

oats

medium

arborio

wild

red

corn

barley

long

grain

basmati

yams

potatoes

storing

short

rice

brown

russet

sweet

STARCHES WORD SEARCH - ANSWERS

	a	b	c	d	e	f	g	h	i	j	k	l
1	s	t	o	r	i	n	g	b	i	o	a	u
2	e	i	s	u	o	o	w	m	t	e	o	r
3	o	t	r	o	h	s	e	e	c	e	i	m
4	t	a	e	h	w	d	e	k	c	a	r	c
5	a	m	r	s	i	w	e	k	g	o	o	y
6	t	s	o	u	s	y	e	l	r	a	b	a
7	o	a	m	e	c	u	o	c	a	t	r	m
8	p	b	r	o	w	n	r	a	i	s	a	s
9	e	e	r	i	g	i	t	o	n	r	m	s
10	d	n	l	d	d	r	t	e	t	o	d	i
11	b	d	l	r	c	r	b	u	i	s	u	m
12	e	t	s	r	o	s	o	i	t	d	a	e

(L4, W) cracked wheat

(K6, W) barley

(A1, E) storing

(J5, S) oats

(H6, SW) long

(F3, W) short

(H2, SW) medium

(I5, S) grain

(J9, NW) rice

(K8, N) arborio

(B8, N) basmati

(B8, E) brown

(E8, SW) wild

(L5, S) yams

(G8, NW) russet

(C8, SW) red

(A8, N) potatoes

(E6, NE) sweet

(E7, SW) corn

TO FIND THE WORD USE THE LEGEND. THE WORD STARTS WHERE THE TWO LINES MEET (L AND 4 IN THE CASE OF CRACKED WHEAT) AND MOVES IN THE DIRECTION INDICATED (I.E. W = WEST, SE = SOUTH EAST AND SO ON)



LESSON PLAN - STARCHES - NUMBERED WORD DEFINITION MATCH

From the kitchen of **VEGETABLES & STARCHES**

■ Purpose and Practice:

- To work on Starches vocabulary.

■ Ingredients

Page 236
 Numbered Word
 Definition Exercise

Page 237
 Numbered Word
 Definition Answer
 Key

■ Method

- Instructor makes appropriate number of the word search handouts for the class
- Instructor hands out `` Word Search Exercise `` sheet for the students to use.
- Students will use the words on the bottom of the page and find those words in the word search above.
- Come together as a class to go over the activity with instructors answer key.

■ Cooking Time

30 minutes

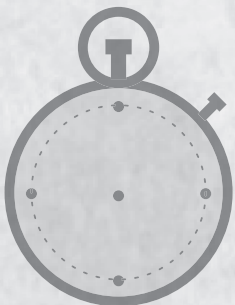

■ Essential Skills being practiced

- ✓ Document Use
- ✓ Thinking Skills
- ✓ Reading skills

Tip:

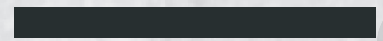

STARCHES DEFINITIONS - NUMBERED WORD DEFINITION MATCH

Match the description on the right with the list on the left, write the name next to the definition.

1. Cracked Wheat _____ : waxy flesh best suited to boiling or steaming
2. Short grain rice _____ : finest long grained rice in the world
3. Russet _____ : grains remain firm, fluffy and separate when cooked
4. Arborio rice _____ : native to the new world
5. Yams _____ : flesh changes from creamy white to deep red
6. Oats _____ : cooked by long gentle simmering
7. Red Potatoes _____ : quite tender and sticky when cooked
8. Wild Rice _____ : the seed of an unrelated reed like aquatic plant
9. Sweet Potatoes _____ : only grain that can be eaten as a fresh vegetable
10. Brown Rice _____ : different botanical family than ordinary potatoes
11. Long grain rice _____ : best potatoes for frying
12. Potatoes _____ : are consumed daily as a hot breakfast cereal
13. Basmati Rice _____ : rice absorbs more water and takes longer to cook
14. Barley _____ : Parboiled to remove the surface starch
15. Converted rice _____ : is very sticky, with a white color and mild flavour
16. Corn _____ : Can be used to thicken soups or stews.

STARCHES DEFINITIONS - NUMBERED WORD DEFINITION MATCH ANSWERS

Match the description on the right with the list on the left, write the name next to the definition.

1. Cracked Wheat Red Potatoes : waxy flesh best suited to boiling or steaming
2. Short grain rice Basmati Rice : finest long grained rice in the world
3. Russet Long grain rice : grains remain firm, fluffy and separate when cooked
4. Arborio rice Potatoes : native to the new world
5. Yams Yams : flesh changes from creamy white to deep red
6. Oats Cracked Wheat : cooked by long gentle simmering
7. Red Potatoes Short grain rice : quite tender and sticky when cooked
8. Wild Rice Wild Rice : the seed of an unrelated reed like aquatic plant
9. Sweet Potatoes Corn : only grain that can be eaten as a fresh vegetable
10. Brown Rice Sweet Potatoes : different botanical family than ordinary potatoes
11. Long grain rice Russet : best potatoes for frying
12. Potatoes Oats : are consumed daily as a hot breakfast cereal
13. Basmati Rice Brown Rice : rice absorbs more water and takes longer to cook
14. Barley Converted rice : Parboiled to remove the surface starch
15. Converted rice Arborio rice : is very sticky, with a white color and mild flavour
16. Corn Barley : Can be used to thicken soups or stews.



LESSON PLAN - STARCHES - GRAINS

From the kitchen of **VEGETABLES & STARCHES**

■ Purpose and Practice:

- To work on Grains vocabulary.

■ Ingredients

Page 239
Grains - Exercise

Page 240
Grains - Answer
Key

■ Method

- Instructor makes appropriate number of the word search handouts for the class
- Instructor hands out `` Word Search Exercise `` sheet for the students to use.
- Students will use the words on the bottom of the page and find those words in the word search above.
- Come together as a class to go over the activity with instructors answer key.

■ Cooking Time

30 minutes

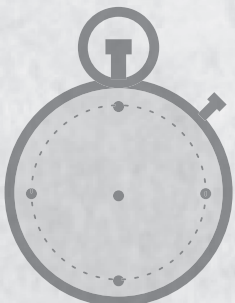

■ Essential Skills being practiced

- ✓ Document Use
- ✓ Thinking Skills
- ✓ Reading skills

Tip:

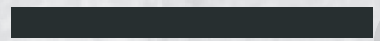

GRAINS - EXERCISE

Instructions: Fill in the blanks by using the list of terms below.

1. long grain, medium grain and short grain.
2. fresh
3. firm, fluffy and separate
4. originally
5. drying and grinding
6. grasses
7. sticky

Grains are _____ that bear edible seeds. Corn, rice, and wheat are the most significant.

Rice – is the starchy seed of a semiaquatic grass. Rice is used as a staple for half the world's population. Rice is divided into three types based on seed: _____, _____ and _____.

Corn – is the only grain that can be eaten as a _____ vegetable. Cornmeal is made by and _____ a special type of corn known as dent, which may be yellow white or blue.

Long grain rice - is most versatile and popular, the grains remain _____, _____ and _____ when cooked.

Short grain rice - has more starch and becomes quite tender and _____ when cooked. Italian risotto, Japanese sushi is all traditionally made with short grain rice.

Medium Grain rice - the appearance and starch content of medium grained rice falls somewhere in between.

All rice is _____ brown.

GRAINS - EXERCISE ANSWERS

Instructions: Fill in the blanks by using the list of terms below.

1. long grain, medium grain and short grain.
2. fresh
3. firm, fluffy and separate
4. originally
5. drying and grinding
6. grasses
7. sticky

Grains are Grasses that bear edible seeds. Corn, rice, and wheat are the most significant.

Rice – is the starchy seed of a semiaquatic grass. Rice is used as a staple for half the world's population. Rice is divided into three types based on seed: Long grain, Medium grain and Short grain.

Corn – is the only grain that can be eaten as a Fresh vegetable. Cornmeal is made by and Drying and Grinding a special type of corn known as dent, which may be yellow white or blue.

Long grain rice - is most versatile and popular, the grains remain Firm, Fluffy and Seperate when cooked.

Short grain rice - has more starch and becomes quite tender and Sticky when cooked. Italian risotto, Japanese sushi is all traditionally made with short grain rice.

Medium Grain rice - the appearance and starch content of medium grained rice falls somewhere in between.

All rice is Originally brown.



COLD KITCHEN - SALADS & DRESSINGS

LESSON PLAN - COLD KITCHEN STUDY SHEETS: SALAD GREENS, SALAD DRESSINGS, PREPARATION METHODS



From the kitchen of **COLD KITCHEN**

Purpose and Practice:

- Reading material previously studied in class and remembering what was learned.

Ingredients

Page 244
Salad Greens

Page 245
Salad Dressings

Page 246
Preparation
Methods

Method

- Instructor makes appropriate number of handouts of the 3 study sheets for the class
- Instructor hands out "Cold Kitchen Study Sheets" and reviews information with the class

Cooking Time

20 minutes

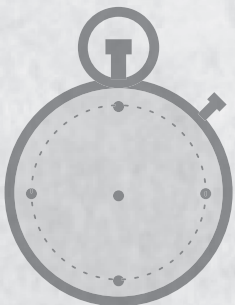

Essential Skills being practiced

- ✓ Thinking Skills
- ✓ Reading Text

Tip:



COLD KITCHEN - STUDY SHEET**SALAD GREENS****LETTUCE**

Most common types of lettuce are butterleaf, iceberg, leaf, and romaine

**ICEBERG**

Iceberg lettuce is the most common out of all the varieties. Iceberg lettuce remains crisp for a relatively long period of time after being out. Select heads that are firm but not hard and leaves that are free of rusty tips.

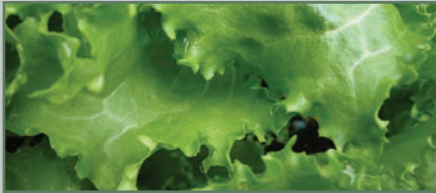
**LEAF**

Leaf lettuce grows in bunches. It has a separate ruffle edged leaves branching from the stalk. It is easily damaged during harvest and transport.

**ROMAINE**

Romaine lettuce also known as cos, is a loosely packed head lettuce with elongated leaves and thick midribs. The outer leaves are dark green. Romaine has enough flavour to stand up to strongly flavoured dressing such as the garlic and parmesan cheese used in a caesar salad.

**CHICORY****BELGIAN ENDIVE**

Belgian endive (Witloof) grows in small tight heads with pointed leaves. It is actually the shoot of a chicory plant.

**RADICCHIO**

Resembles a small red cabbage. Is popular braised or grilled. Due to its attractive colour radicchio is popular in cold salads, but has a bitter flavour and should be used sparingly and mixed with other greens in a tossed salad.

COLD KITCHEN - STUDY SHEET (CON'T)

SALAD DRESSINGS

(dressing) for a salad should complement rather than mask the flavours of the other ingredients. Most are based on either a mixture of oil and vinegar, called vinaigrette, or a mayonnaise or other emulsified product.

VINAIGRETTE DRESSINGS

The simple vinaigrette, also known as basic French dressing, is a temporary emulsion of oil and vinegar seasoned with salt, pepper and mustard. The standard ration is 3 parts oil to 1 part vinegar.

Oil and vinegar repel each other and will separate almost immediately when mixed. They should be whisked immediately before use.



OILS

Many types of oils can be used to make salad dressings. Light, neutral-flavoured oils such as canola, corn, cottonseed, soybean, and safflower are relatively low priced and used extensively for this purpose.

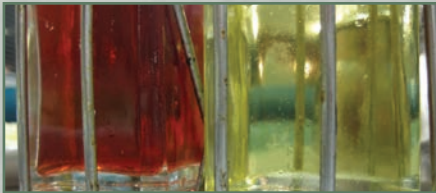

VINEGARS

Many different types of vinegar can be used to make salad dressings. Red wine vinegar is the most common because it is inexpensive and its flavour blends well with many foods. But other vinegars such as cider, balsamic, white wine and rice are also used. Acidic juices such as lemon, orange and lime are sometimes substituted for all or part of the vinegar in a salad.



MAYONNAISE

Mayonnaise is an **emulsified** sauce. An emulsified sauce is formed when two liquids that would not ordinarily form a stable mixture are forced together and held in suspension. The higher the proportion of oil to vinegar, the thicker the sauce will be.



EMULSIFIED VINAIGRETTE DRESSINGS

An emulsified vinaigrette is a standard vinaigrette dressing emulsified with whole eggs, modified starches or vegetable gum. Its taste is similar to basic vinaigrette, but will not separate and it clings to green quite easily.

COLD KITCHEN - STUDY SHEET (CON'T)

PREPARATION METHODS

There are two types of **green salads: tossed and composed**. The more informal **tossed salad** is prepared by placing the greens, garnishes and dressing in a large bowl and tossing to combine. A **composed salad** usually has a more elegant look to it. It is prepared by arranging each of the ingredients on plates in an artistic fashion. **Bound salads**, which are cooked meats, poultry, fish, shellfish, pasta or potato bound with a dressing, the binding agent can be either vinaigrette or mayonnaise based. **Vegetable salad** and **fruit salad** are other types of salads that can be made.

There are usually four components: the base, body, garnish and dressing.

The **base** is usually salad greens that partially line or anchor the plate on which the salad will be served. Depending on the desired effect, the leaves can be cup shaped or flat.

The **body** is the main ingredient. It can be lettuce or other greens, or another salad made from cooked or blended ingredients, such as chicken salad or fruit salad.

The **garnish** is added to the salad for color, texture and flavour. It can be substantial as a grilled, sliced duck breast or as simple as a sprinkling of chopped herbs; it can be warm or cold. The choice is unlimited but whatever is used should complement and balance the flavour of the body.

The salad **dressing** should complement rather than mask the other flavours in the salad. If the body already contains a dressing, as in a bound salad, additional dressing may not be necessary.

LESSON PLAN - COLD KITCHEN - FILL IN THE BLANKS



From the kitchen of **COLD KITCHEN**

Purpose and Practice:

- Students will practice recalling the information that was read during Lesson Plan 1: Cold Kitchen Study Sheets

Ingredients

Page 248
Cold Kitchen – Fill
in the Blanks

Page 249
Cold Kitchen – Fill
in the Blanks –
Answer Key

Method

- Instructor makes appropriate number of “Cold Kitchen – Fill in the Blanks” exercise sheets
- Instructor hands out “Cold Kitchen - Fill in the Blanks” exercise sheet to the class
- Once completed, Instructor will go over the information with the class using the answer sheet in the kit

Cooking Time

30 minutes

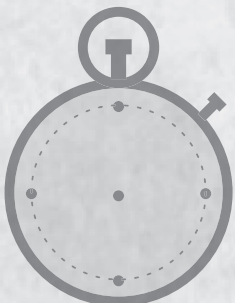

Essential Skills being practiced

- ✓ Thinking Skills
- ✓ Document Use

Tip:



COLD KITCHEN - FILL IN THE BLANKS

Use the words below to fill in the blanks of the sentences.

leaf	emulsion	composed	garnish
iceberg	belgian endive	bound salads	dressing
romaine	vinaigrette	base	
radicchio	tossed	body	

- Most common types of lettuce are butterleaf, _____, _____, and _____
- The _____ is usually salad greens that partially line or anchor the plate on which the salad will be served.
- The simple _____, also known as basic French dressing, is a temporary _____ of oil and vinegar seasoned with salt, pepper and mustard.
- The more informal _____ salad is prepared by placing the greens, garnishes and dressing in a large bowl and tossing to combine
- Due to its attractive colour _____ is popular in cold salads.
- The salad _____ should complement rather than mask the other flavours in the salad.
- It is actually the shoot of a chicory plant. _____ (Witloof) grows in small tight heads with pointed leaves.
- Prepared by arranging each of the ingredients on plates in an artistic fashion. A, _____ salad has a more elegant look to it.
- The _____ is the main ingredient. It can be lettuce or other greens, or another salad made from cooked or blended ingredients.
- Salads that have cooked meats, poultry, fish, shellfish, pasta or potato bound with a dressing are called _____
- The _____ is added to the salad for color, texture and flavour.

COLD KITCHEN - FILL IN THE BLANKS - ANSWERS

Use the words below to fill in the blanks of the sentences.

leaf	emulsion	composed	garnish
iceberg	belgian endive	bound salads	dressing
romaine	vinaigrette	base	
radicchio	tossed	body	

- Most common types of lettuce are butterleaf, leaf, iceberg, and romaine.
- The base is usually salad greens that partially line or anchor the plate on which the salad will be served.
- The simple vinaigrette, also known as basic French dressing, is a temporary emulsion of oil and vinegar seasoned with salt, pepper and mustard.
- The more informal tossed salad is prepared by placing the greens, garnishes and dressing in a large bowl and tossing to combine.
- Due to its attractive colour radicchio is popular in cold salads.
- The salad dressing should complement rather than mask the other flavours in the salad.
- It is actually the shoot of a chicory plant. belgian endive (Witloof) grows in small tight heads with pointed leaves.
- Prepared by arranging each of the ingredients on plates in an artistic fashion. A, composed salad has a more elegant look to it.
- The body is the main ingredient. It can be lettuce or other greens, or another salad made from cooked or blended ingredients.
- Salads that have cooked meats, poultry, fish, shellfish, pasta or potato bound with a dressing are called bound salad.
- The garnish is added to the salad for color, texture and flavour.



LESSON PLAN - COLD KITCHEN - WORDMATCH

From the kitchen of **COLD KITCHEN**

Purpose and Practice:

- To practice matching Cold Kitchen vocabulary to its corresponding definition

Ingredients

Page 251
Cold Kitchen –
Word Match

Page 252
Cold Kitchen
– Word Match
Answer Key

Method

- Instructor makes appropriate number of Cold Kitchen Word Match exercise sheets
- Instructor hands out “Cold Kitchen – Hidden Word Match exercise sheet to the class
- Once completed, Instructor will go over the information with the class using the answer sheet in the kit

Cooking Time

30 minutes

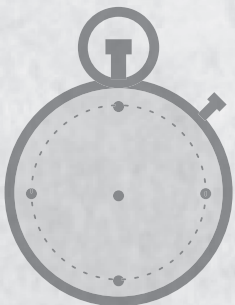

Essential Skills being practiced

- ✓ Thinking Skills
- ✓ Document Use

Tip:



COLD KITCHEN - WORDMATCH

Match the description on the right with the list on the left, write the name next to the definition.

- A. iceberg _____ Most common out of all the varieties
- B. leaf _____ It has a separate ruffle edged leaves branching from the stalk
- C. romaine _____ Which are cooked meats, poultry, fish, shellfish, pasta or potato bound with a dressing
- D. belgian endive _____ Prepared by arranging each of the ingredients on plates in an artistic fashion
- E. radicchio _____ Grows in small tight heads with pointed leaves
- F. vinaigrette _____ Added to the salad for color, texture and flavour
- G. emulsified _____ Should complement rather than mask the other flavours in the salad
- H. tossed salad _____ Loosely packed head lettuce with elongated leaves and thick midribs
- I. composed salad _____ Is formed when two liquids that would not ordinarily form a stable mixture are forced together and held in suspension
- J. bound salads _____ A temporary emulsion of oil and vinegar seasoned with salt, pepper and mustard
- K. base _____ Popular in cold salads, but has a bitter flavour and should be used sparingly
- L. body _____ The main ingredient
- M. garnish _____ Salad greens that partially line or anchor the plate on which the salad will be served
- N. dressing _____ Placing the greens, garnishes and dressing in a large bowl and tossing to combine

COLD KITCHEN - WORDMATCH - ANSWERS

Match the description on the right with the list on the left, write the name next to the definition.

- A. iceberg iceberg Most common out of all the varieties
- B. leaf leaf It has a separate ruffle edged leaves branching from the stalk
- C. romaine bound salads Which are cooked meats, poultry, fish, shellfish, pasta or potato bound with a dressing
- D. belgian endive composed salad Prepared by arranging each of the ingredients on plates in an artistic fashion
- E. radicchio iceberg Grows in small tight heads with pointed leaves
- F. vinaigrette radicchio Added to the salad for color, texture and flavour
- G. emulsified dressing Should complement rather than mask the other flavours in the salad
- H. tossed salad romaine Loosely packed head lettuce with elongated leaves and thick midribs
- I. composed salad emulsified Is formed when two liquids that would not ordinarily form a stable mixture are forced together and held in suspension
- J. bound salads vinaigrette A temporary emulsion of oil and vinegar seasoned with salt, pepper and mustard
- K. base radicchio Popular in cold salads, but has a bitter flavour and should be used sparingly
- L. body body The main ingredient
- M. garnish base Salad greens that partially line or anchor the plate on which the salad will be served
- N. dressing tossed salad Placing the greens, garnishes and dressing in a large bowl and tossing to combine



LESSON PLAN - COLD KITCHEN - HIDDEN WORD PUZZLE

From the kitchen of COLD KITCHEN

Purpose and Practice:

- To practice locating learned Cold Kitchen vocabulary in a puzzle format

Ingredients

Page 254
Cold Kitchen – Hidden Word Puzzle
Page 255
Cold Kitchen – Hidden Word Puzzle Answer Key

Method

- Instructor makes appropriate number of Cold Kitchen Hidden Word Puzzle exercise sheets
Instructor hands out "Cold Kitchen – Hidden Word Puzzle" exercise sheet to the class
Learners can refer to the Hidden Word Answer Key if they are struggling to find a word or they can compare with their co-learners

Cooking Time

20 minutes

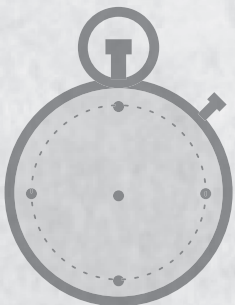

Essential Skills being practiced

- Thinking Skills
Document Use

Tip:

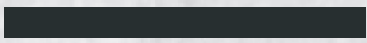

COLD KITCHEN - HIDDEN WORD PUZZLE

Find the words below in this word search puzzle.

s n s n e i i o i b s l r
 e v i d n e n a i g l e b
 t v c r o m a i n e s a b
 t i e e d u h d s a a f a
 e g b s e l f a i i l s g
 r i e s s s l i i d a g a
 g d r i o i h c c i d a r
 i r g n p f e b o d y e n
 a s r g m i y s d n n c i
 n s i e o e o e f u a d s
 i a y e c d e s s o t s h
 v s u o o o i s e b b n y
 i r c l o i i a g s i i i

iceberg

leaf

romaine

dressing

body

vinaigrette

emulsified

raddicchio

tossed

belgian endive

composed

salad

base

garnish

bound

COLD KITCHEN - HIDDEN WORD PUZZLE - ANSWERS

Find the words below in this word search puzzle.

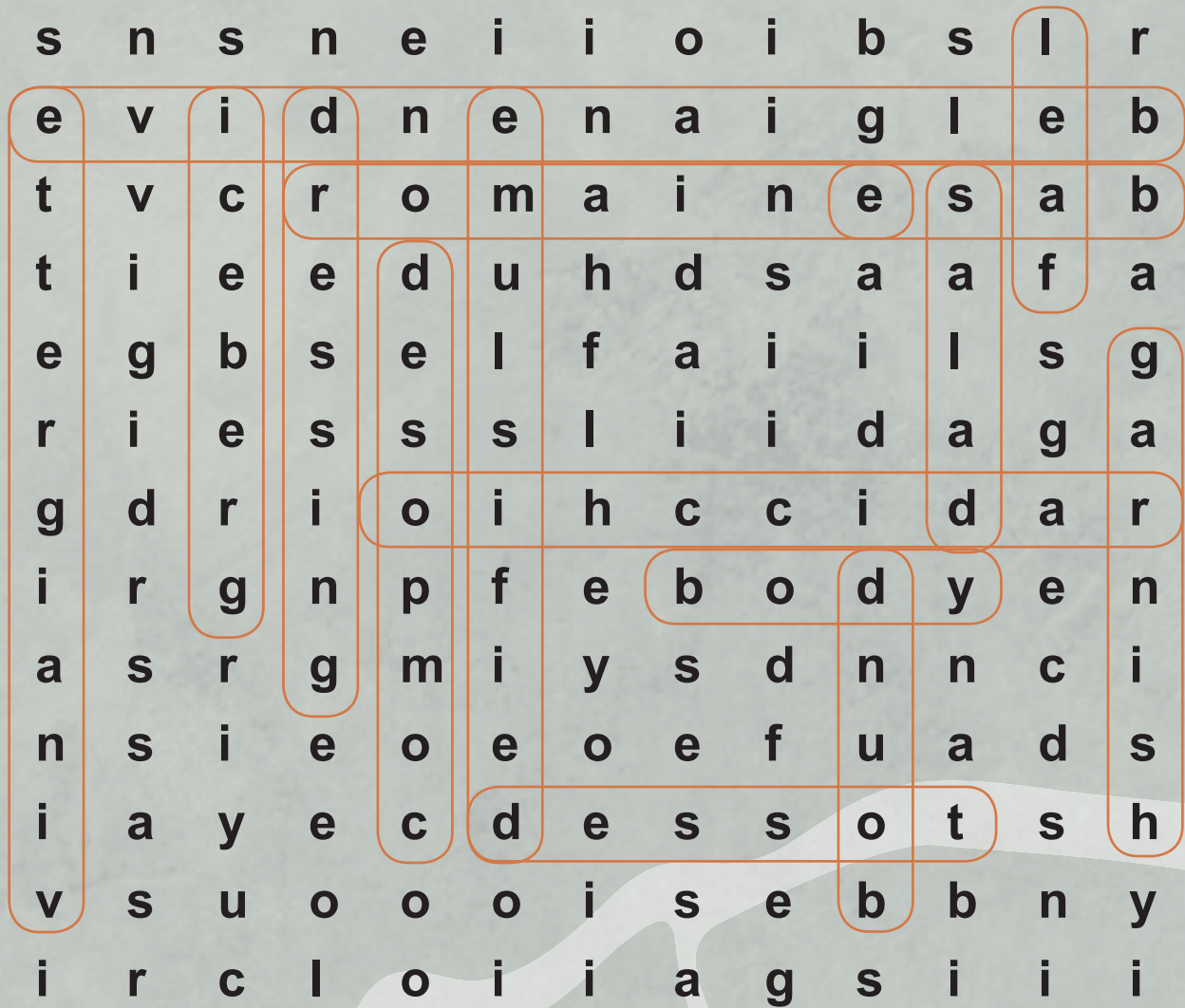

iceberg

leaf

romaine

dressing

body

vinaigrette

emulsified

raddicchio

tossed

belgian endive

composed

salad

base

garnish

bound



LESSON PLAN - COLD KITCHEN - WORD SCRAMBLE

From the kitchen of **COLD KITCHEN**

Purpose and Practice:

- To practice unscrambling learned Cold Kitchen vocabulary in a scrambled word puzzle format

Ingredients

Page 257
Cold Kitchen –
Word Scramble

Page 258
Cold Kitchen –
Word Scramble
Puzzle Answer Key

Method

- Instructor makes appropriate number of Cold Kitchen Word Scramble exercise sheets
- Instructor hands out “Cold Kitchen – Word Scramble” exercise sheet to the class
- Once completed, Instructor will go over the information with the class using the answer sheet in the kit

Cooking Time

30 minutes

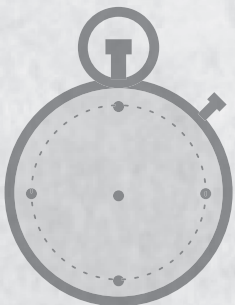

Essential Skills being practiced

- ✓ Thinking Skills
- ✓ Document Use

Tip:

This exercise can be challenging for some. Try working in pairs.

COLD KITCHEN - WORD SCRAMBLE

Find the correct spelling for the scrambled words below .

crbgeei	
arientietgv	
eomarni	
ichoaicrd	
ostsde ladsa	
iflieeudsm	
eabs	
hnrissag	
eisngsrd	
elaf	
iasaemnonny	
giblanc dienv	
pedmosco lasda	
Nodub asdal	
doyb	

COLD KITCHEN - WORD SCRAMBLE - ANSWERS

Find the correct spelling for the scrambled words below .

crbgeei	iceberg
arientietgv	vinaigrette
eomarni	romaine
ichoaicrd	radicchio
ostsde ladsa	tossed salad
iflieudsm	emulsified
eabs	base
hnrissag	garnish
eisngsrd	dressing
elaf	leaf
iasaemnonny	mayonnaise
giblanc dienv	belgian endive
pedmosco lasda	composed salad
Nodub asdal	bound salad
doyb	body



LESSON PLAN - HOT OR COLD SANDWICHES - POSTER

From the kitchen of **COLD KITCHEN**

■ Purpose and Practice:

- To work as a team to review the principles behind the preparation of Hot or Cold Sandwiches

■ Ingredients

Page 260
Hot or Cold
Sandwiches Poster

Page 261
Hot or Cold
Sandwiches
Exercise

Page 262
Hot or Cold
Sandwiches
Exercise Answer
Key

■ Method

- Instructor makes appropriate number of Hot or Cold Sandwiches Posters
- Instructor makes appropriate number of Hot or Cold Sandwiches exercise sheets
- Instructor divides the class into small groups
- Instructor hands out exercise sheet to the class and a poster for each team
- Once completed, Instructor will go over the information with the class using the answer sheet in the kit

■ Cooking Time

30 minutes

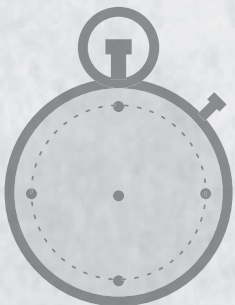

■ Essential Skills being practiced

- ✓ Document Use
- ✓ Thinking Skills
- ✓ Working with Others

Tip:

Hang the poster in a strategic place for easy reference after the exercise has taken place.

HOT OR COLD SANDWICHES - 11 X 17 POSTER

This poster can be found on

Essential Skills Companion Kit for Culinary Arts Trades Training

HOT or COLD Sandwiches

Sandwiches must be prepared under strict sanitation and hygiene conditions because they are generally served uncooked.



GENERAL RULES:

- 1: Correct sanitation procedures observed.
- 2: Only quality products used.
- 3: All products are fresh.
- 4: Moisture balance is correct.
- 5: Proper work methods have been followed, particularly with respect to neatness, productivity and convenience.
- 6: The product is appealing to the eye; your sandwich should be neat, arranged appeal and garnished appropriately.
- 7: Portion size is appropriate.
- 8: The cost of food is within the range allotted for it.

Freshness is one of the major qualities desired, whether the sandwich is prepared to order or mass produced. You should carefully estimate the number of sandwiches you need in a day and never keep or use sandwiches that are over twenty four hours old.

BREADS

As well as ensuring that the bread is fresh, it is also desirable to use a variety of breads in sandwich making.



SPREADS

Spreads softened butter or margarine to the edges of the bread slices. Softened butter, margarine, cream cheese and peanut butter will form a protective coating that prevents moist fillings from soaking the bread.



Mayonnaise or salad dressing, if spread directly onto the bread will also soak into the soggy bread.



Avoid melted butter or margarine, as these will soak into the bread and make a soggy sandwich.



FILLINGS

Make sure fillings are applied evenly across the bread slice and that enough is used to make the sandwich attractive and appetizing.



Ensure that the filling is neither too dry nor too moist, and that it is correctly seasoned. Make sure that moist fillings such as tuna or egg salad have an easy to spread consistency.



Greens such as lettuce and watercress should be used only in sandwiches that are to be eaten at once.



HOT FILLINGS

The most common type of hot filling is probably the hamburger patty. It is important to remember that when making a sandwich with a hot filling that you ensure the filling is hot. The filling should be cooked until the internal temperature reaches at least 74 degrees C before being removed from the cooking surface. The product may then be held at a temperature not lower than 60 degrees C.



COLD KITCHEN - SALADS & DRESSINGS

HOT OR COLD SANDWICHES - EXERCISE

Read the poster called Hot or Cold Sandwiches and use the information to answer the questions below:

1. Name 3 general rules about making a hot or cold sandwich?

2. What is one of the major qualities in making a good sandwich?

3. What is the maximum time a sandwich can be kept if not eaten right away?

4. Why should you avoid putting melted butter on a sandwich?

5. When adding the fillings, what is the proper way they should be applied?

6. What is important about the temperature of 74° C?

HOT OR COLD SANDWICHES - EXERCISE - ANSWERS

Read the poster called Hot or Cold Sandwiches and use the information to answer the questions below:

1. Name 3 general rules about making a hot or cold sandwich?

Refer to poster General Rules: 8 rules that could be used

2. What is one of the major qualities in making a good sandwich?

Freshness is one of the major qualities in making a sandwich

3. What is the maximum time a sandwich can be kept if not eaten right away?

The maximum time for a sandwich to be kept is 24 hours

4. Why should you avoid putting melted butter on a sandwich?

Avoid melted butter as it will make the bread soggy

5. When adding the fillings, what is the proper way they should be applied?

Fillings should be applied evenly to make it attractive and appetizing

6. What is important about the temperature of 74° C?

74° C is the internal temperature hot fillings should be cooked to before removing from the cooking surface



LESSON PLAN - SALAD DRESSINGS 101 - INTRODUCTION

From the kitchen of **COLD KITCHEN**

■ Purpose and Practice:

- Using excerpts from Chef Nathan Hyam’s “Salad Dressings 101” cookbook, learners will practice reading text and respond to questions regarding the general layout of a cookbook

■ Ingredients

Pages 264 and 265
Introduction

Page 266
Cover Page

Page 267
Contents page

Page 268, 269, 270
Dressings for
all Occasions –
Exercise

Page 271, 272, 273
Dressings for all
Occasions Answer
Key

■ Method

- Instructor makes appropriate number of copies of the Introduction handouts for each learner and one copy of the Exercise sheets
- Instructor guides learners to read through the information and as a team and record their answers on the exercise sheets
- Once completed, Instructor posts the answers on a wall and invites the team to come up and check their answers

■ Cooking Time

60 minutes

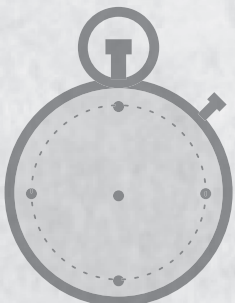

■ Essential Skills being practiced

- ✓ Document Use
- ✓ Thinking Skills
- ✓ Working with Others
- ✓ Oral Communication
- ✓ Writing

Tip:

Hang the poster in a strategic place for easy reference after the exercise has taken place.

SALAD DRESSINGS 101 - INTRODUCTION

Salad Dressings

Eating fresh raw food is a culinary link to our distant ancestors. Historical records show that the Romans, Egyptians and Babylonians all enjoyed various types of salads with flavoured dressings as a part of their diet thousands of years ago. Foraging for greens and edible plants is part of our cellular memory. The word *salad* conjures up images of health, new growth and pleasant weather. Perhaps this is why eating salads can make you feel so good. They are an edible symbol of nature, a hint of green pastures or a lush country garden right at your table, no matter where you live.



The incredible diversity of produce available today makes an entire new range of dishes possible. However, although the multiplicity of greens and vegetables used in a salad will give a solid foundation of taste to the dish, most people would agree that the key flavouring element is the dressing. A perfectly matched dressing can tie together all the individual elements of a salad to create a culinary symphony.

Matching Dressings to Ingredients

There are infinite ways to transform a bowl of greens just by choosing an appropriate dressing. A carefully chosen dressing can transform a simple salad into a special occasion dish.

The dressing can be a spectacular combination of zesty flavours and aromas but it is best to remember that it is really a seasoning meant to enhance the main ingredients. It should augment their flavours, not overpower them. The art of matching a dressing to a salad calls for some analysis of both the salad ingredients and the dressing.

Translucent mixtures of oil and vinegar, with added taste elements such as herbs, are best when paired with a leafy green.

Creamy dressings with their thicker texture are ideal with heavier ingredients like vegetables, pastas, grains or potatoes and meats.

Vinaigrettes (from the French *vin aigre* - "sour wine") are very versatile and can be used to dress most types of salads.



(Thank you to Chef Nathan Hyam for giving permission to copy from Salad Dressing 101)

SALAD DRESSINGS 101 - INTRODUCTION (CON'T)

A question to ask in helping you choose a dressing is: Are the flavours of the salad ingredients predominantly strong or mild? A subtly flavoured green like butter lettuce will be overwhelmed by a pungent creamy caesar dressing.

Texture is another important consideration. A soft delicate mache leaf will be squashed by a heavy mayonnaise-based dressing, but the same dressing could be an ideal complement to sliced vegetables or a sturdy lettuce like romaine.

When a salad is a part of a larger meal it is important to determine whether or not the dressing will harmonize with the other flavours in the meal. The herbs or spices used in the salad dressing could compliment the other flavours or clash. A weighty entree like beef stew calls for a light leafy green salad with a simple oil and lemon dressing. A dressing based on orange juice could harmonize well with a curry entree but it would be redundant with an entree of orange ginger chicken.

When to Add the Dressing

The dressing for most salads, in particular leafy greens, should be added as close to the serving time as possible, or separately so the diner can decide on the amount to be added.

It is essential to be aware of the consequences of adding dressing to a green salad too far in advance of it being served. Most dressings contain acids such as vinegar or lemon juice. This acid will cause the greens to wilt and get soggy as soon as the salad is tossed with the dressing. The salad will get soggy as the time increases before it is eaten. However, this rule has an exception. Salads without leafy greens, such as potato or pasta salad, actually improve in flavor when they are allowed to marinate in the dressing for an hour or longer.

Emulsions

The two most common types of dressings are vinaigrettes and creamy dressing. These are both examples of emulsified dressings. Emulsifying means combining two liquids that don't usually mix together easily. In a salad dressing the two liquids would normally be oil and vinegar. Acidic liquids like vinegar or lemon juice help the process a little by changing the pH of the mixture.

Starting with the vinegar in a bowl, the oil is added very slowly, usually a drop by drop, while beating vigorously. This disperses and suspends small drops of the liquids throughout each other. It is essential for the oil to be added slowly or the two liquids will not combine.

The two liquids will remain combined for a short period of time but will soon separate. The harder the mixture is beaten or stirred, the longer it will take to separate. This is because the oil and vinegar are broken into smaller droplets. The smaller the droplets are, the stronger the emulsion is.

To change the temporary emulsion into a permanent emulsion a third ingredient must be added - an emulsifier. Egg yolks and mustard are examples of emulsifiers. They act to stabilize the two different liquids by forming a layer around each of the tiny droplets and holding them in suspension. Mayonnaise is an example of a permanent emulsion. The harder a mayonnaise is beaten to break up the droplets, the more stable it becomes.

It is important to note that emulsions form more easily at room temperature because cold oil is more difficult to break up into small droplets that will create a more stable emulsion.

SALAD DRESSINGS 101 - COVER PAGE

SALAD DRESSING 101

• dressings for all occasions •

edited by NATHAN HYAM

METIS SKILLS AND EDUCATION
CENTRE LIBRARY

CULINARY ARTS

SALAD DRESSINGS 101 - DRESSINGS FOR ALL OCCASIONS - EXERCISE

Use pages 266 and 267 to answer the following questions.

1. Have a look at the cover page and decide who edited this book called "Salad Dressings 101":

2. Look at the page opposite the Contents page and find which year the second edition was published:

3. Using the Contents page, answer the following questions:

Caesar Recipes start on which page?

What kinds of recipes can be found starting on page 141?

Where is the Index?

SALAD DRESSINGS 101 - DRESSINGS FOR ALL OCCASIONS - EXERCISE

4. Read the Introduction (pg 31, 33) and answer the following questions:

Salads and Dressings:

According to Chef Nathan, what kind of images does the word “salad” conjure up?

Matching Dressings to Ingredients:

Draw a line to match up the type of dressing to the most appropriate salad:

Creamy Dressings

Leafy Greens

Mixtures of oil, vinegar and herbs

Most types of salad

Vinaigrettes

Vegetables, pastas

What question should you ask to help you choose a dressing?

What will likely happen if you put a heavy mayonnaise-based dressing on a soft, delicate leaf?

What type of dressing would go well on a salad that is being served with beef stew?

When to Add the Dressing

When should dressing be added to most salads?

What type of salad improves with flavour when allowed to marinate in the dressing?

SALAD DRESSINGS 101 - DRESSINGS FOR ALL OCCASIONS - EXERCISE

Emulsions:

What are the two most common types of dressings?

What does “emulsifying” mean?

Name two emulsifiers that can be added to oil and vinegar to produce a permanent emulsion?

What is an example of a permanent emulsion?

At which temperature do emulsions form more easily?

SALAD DRESSINGS 101 - DRESSINGS FOR ALL OCCASIONS - ANSWERS

Use pages 35 and 37 to answer the following questions.

1. Have a look at the cover page and decide who edited this book called "Salad Dressings 101":

Nathan Hyam

2. Look at the page opposite the Contents page and find which year the second edition was published:

2010

3. Using the Contents page, answer the following questions:

Caesar Recipes start on which page?

91

What kinds of recipes can be found starting on page 141?

Noodle and Potato Salads

Where is the Index?

167

SALAD DRESSINGS 101 - DRESSINGS FOR ALL OCCASIONS - ANSWERS

4. Read the Introduction (pg 31, 33) and answer the following questions:

Salads and Dressings:

According to Chef Nathan, what kind of images does the word “salad” conjure up?

Health, new growth and pleasant weather

Matching Dressings to Ingredients:

Draw a line to match up the type of dressing to the most appropriate salad:

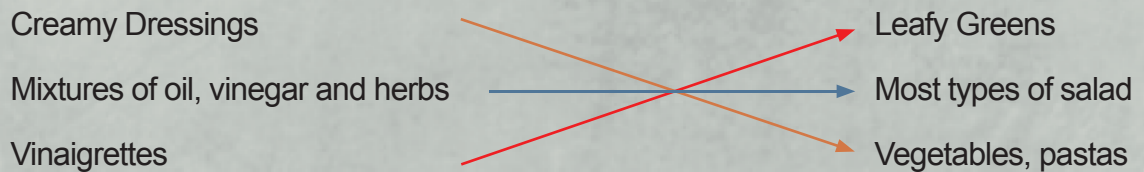

What question should you ask to help you choose a dressing?

Are the salad ingredients mainly strong or mild?

What will likely happen if you put a heavy mayonnaise-based dressing on a soft, delicate leaf?

The dressing will squash the leaf

What type of dressing would go well on a salad that is being served with beef stew?

Simple oil and lemon dressing

When to Add the Dressing

When should dressing be added to most salads?

As close to serving as possible

What type of salad improves with flavour when allowed to marinate in the dressing?

Salads without leafy greens, like potato or pasta salad

SALAD DRESSINGS 101 - DRESSINGS FOR ALL OCCASIONS - ANSWERS

Emulsions:

What are the two most common types of dressings?

Vinaigrettes and creamy dressings

What does “emulsifying” mean?

Combining two liquids that don’t usually mix together easily

Name two emulsifiers that can be added to oil and vinegar to produce a permanent emulsion?

Egg yolks and mustard

What is an example of a permanent emulsion?

mayonnaise

At which temperature do emulsions form more easily?

Room temperature



SEAFOOD COOKERY

**LESSON PLAN - FISH STRUCTURE & MUSCLE COMPOSITION -
FILL IN THE BLANKS**



From the kitchen of **SEAFOOD COOKERY**

■ Purpose and Practice:

- Reading material previously studied in class and remembering what was learned

■ Ingredients

Page 275
(learners' Exercise Sheet)

Page 276
(instructor's answer key)

■ Method

- Instructor prepares appropriate number of "Fish Structure and Muscle Composition" exercise sheets for the learners
- Individually, learners fill in the banks using the words provided to complete the passage.
- Instructor reviews the answers with the class in a group setting

■ Cooking Time

15 - 20 minutes



■ Essential Skills being practiced

- ✓ Reading Text
- ✓ Thinking Skills
- ✓ Writing
- ✓ Document Use

Tip: [REDACTED]

(for oral communication)
Invite learners to discuss what they know about the fish, mollusks and crustaceans used in food service operations.

FISH STRUCTURE AND MUSCLE COMPOSITION - FILL IN THE BLANKS

Cooks prepare and cook a wide variety of foods including fish and seafood. A cook pays special attention to the preparation of fish and shellfish to prevent spoilage and to produce high-quality finished products.

Take a look at the paragraphs below and fill in the blanks with the best word.

skeleton**mollusks****fish****saltwater****crustaceans****fins****round****shape****flatfish**

The fish and shellfish used in food service operations can be divided

into three categories; _____, _____

and _____.

Fish include both fresh and _____ varieties. They

have _____ and an internal _____ of bone and

cartilage. Based on _____ and skeletal structure, fish be

divided into two groups: _____ fish and _____.

FISH STRUCTURE AND MUSCLE COMPOSITION - ANSWERS

Cooks prepare and cook a wide variety of foods including fish and seafood. A cook pays special attention to the preparation of fish and shellfish to prevent spoilage and to produce high-quality finished products.

Take a look at the paragraphs below and fill in the blanks with the best word.

skeleton**mollusks****fish****saltwater****crustaceans****fins****round****shape****flatfish**

The fish and shellfish used in food service operations can be divided

into three categories; **fish**, **mollusks**

and **crustaceans**.

Fish include both fresh and **saltwater** varieties. They

have **fins** and an internal **skeleton** of bone and

cartilage. Based on **shape** and skeletal structure, fish be

divided into two groups: **round** fish and **flatfish**.



LESSON PLAN - FLAT FISH BONE STRUCTURE - PART NAMES

From the kitchen of **SEAFOOD COOKERY**

■ Purpose and Practice:

- Reading material previously studied in class and remembering the parts of a flat fish and what makes them different from a round fish.

■ Ingredients

Page 278
cut out name parts
for a flat fish
Page 279
image of a flat
fish with fill in the
blanks sections
Page 280
image of a flat fish
answer key
- Scissors and glue
sticks

■ Method

- Instructor prepares appropriate number of the first 2 handouts for the learners
- Using scissors and glue sticks, invite learners to cut out the 10 parts to a flat fish and glue the parts on to the appropriate blanks of the exercise sheet.
- Instructor reviews the answers with the class in a group setting and then hands out the answer key for further study purpose.

■ Cooking Time

30 minutes



■ Essential Skills being practiced

- ✓ Thinking Skills
- ✓ Document Use

Tip:

(for oral communication)
Invite learners to discuss the name parts and clues to where such parts belong to the structure of the flat fish.

FLAT FISH BONE STRUCTURE - PART NAMES



BONE STRUCTURE OF FLAT FISH - EXERCISE

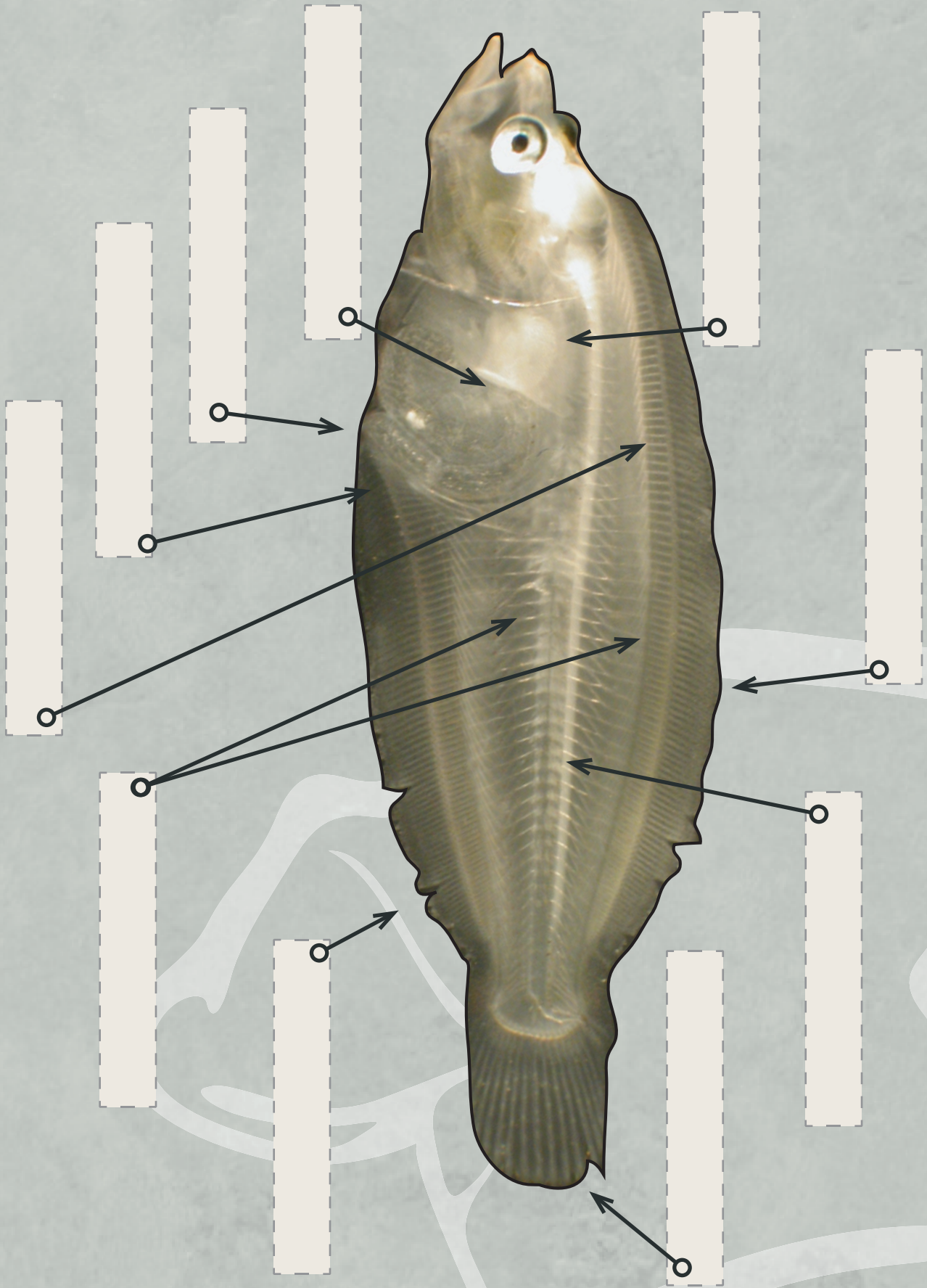

BONE STRUCTURE OF FLAT FISH - ANSWERS

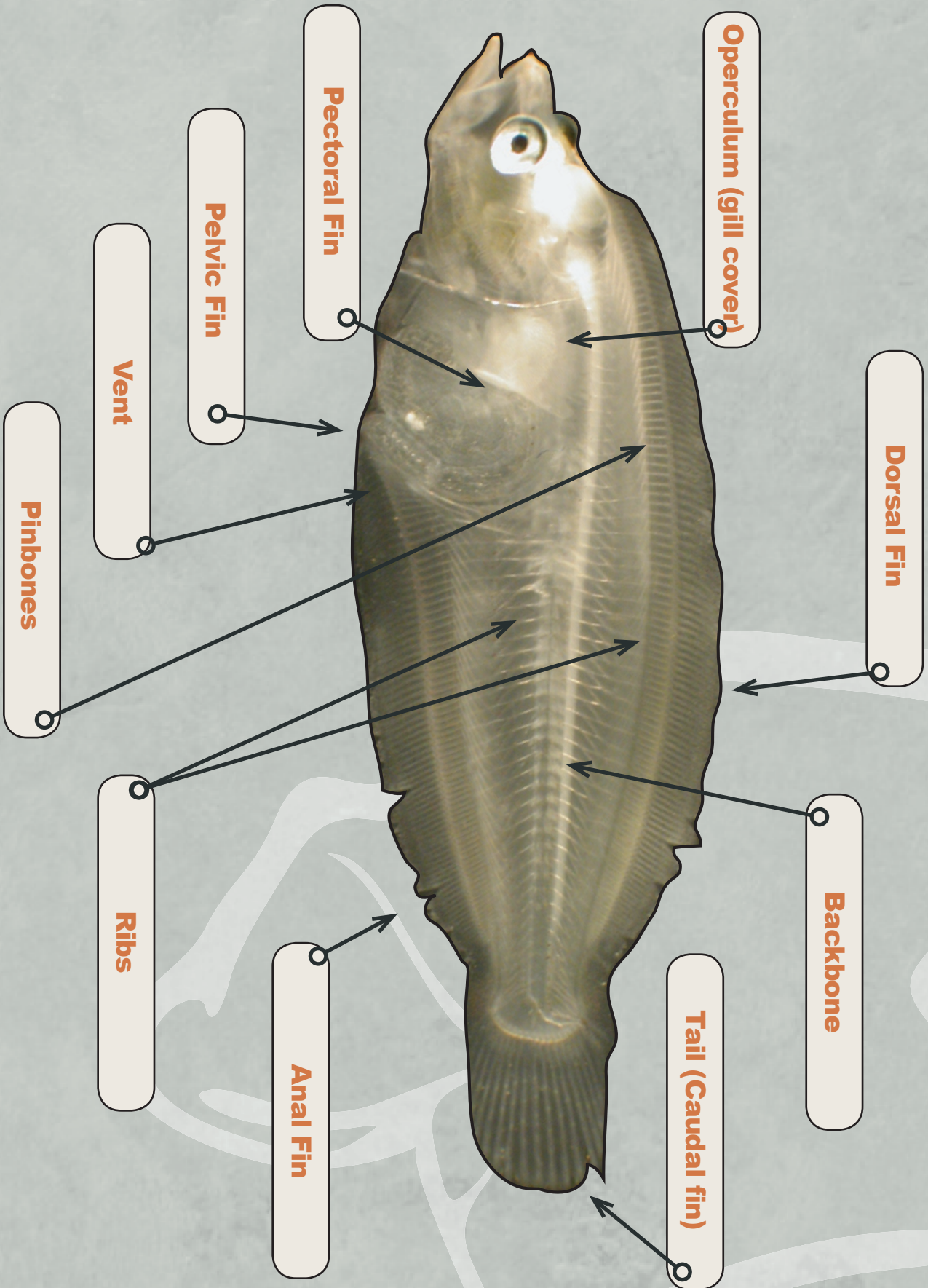



LESSON PLAN - ROUND FISH BONE STRUCTURE - PART NAMES

From the kitchen of **SEAFOOD COOKERY**

■ Purpose and Practice:

- Reading material previously studied in class and remembering the parts of a round fish and what makes them different from a round fish.

■ Ingredients

Page 282
cut out name parts
for a round fish
Page 283
image of a round
fish with fill in the
blanks sections
Page 284
image of a round
fish answer key
- Scissors and glue
sticks

■ Method

- Instructor prepares appropriate number of the first 2 handouts for the learners
- Using scissors and glue sticks, invite learners to cut out the 10 parts to a flat fish and glue the parts on to the appropriate blanks of the exercise sheet.
- Instructor reviews the answers with the class in a group setting and then hands out the answer key for further study purpose.

■ Cooking Time

30 minutes

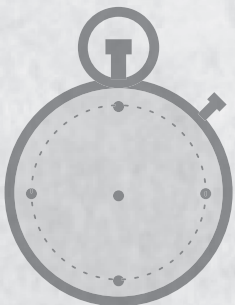

■ Essential Skills being practiced

- ✓ Thinking Skills
- ✓ Document Use

Tip:

(for oral communication)
Invite learners to discuss the name parts and clues to where such parts belong to the structure of the round fish.

ROUND FISH BONE STRUCTURE - PART NAMES

Tail (Caudal fin)

Operculum (gill cover)

Pectoral Fin

Vent

Anal Fin

Dorsal Fin

Backbone

Pelvic Fin

Ribs

Pinbones

BONE STRUCTURE OF ROUND FISH - EXERCISE

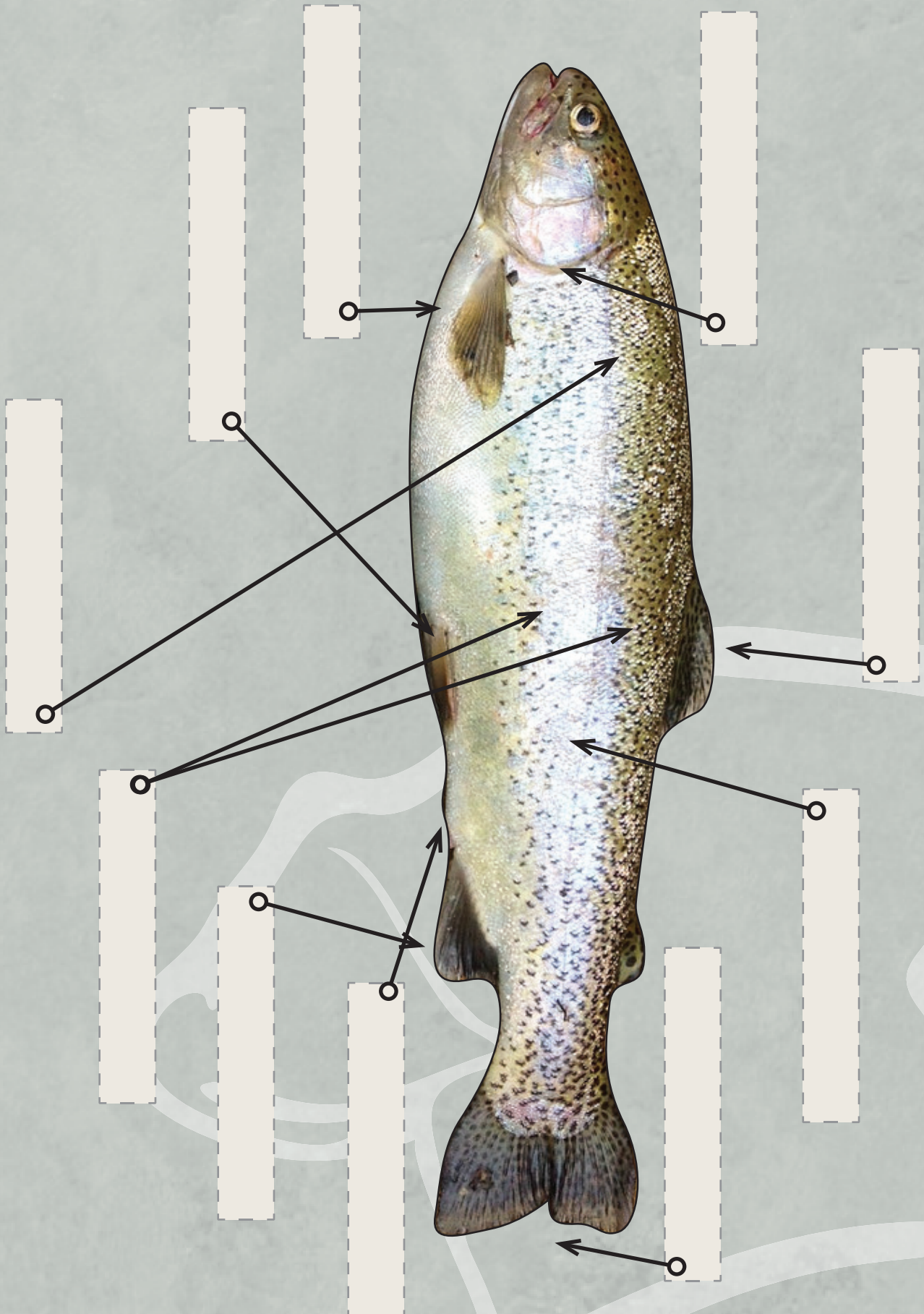

BONE STRUCTURE OF ROUND FISH - ANSWERS

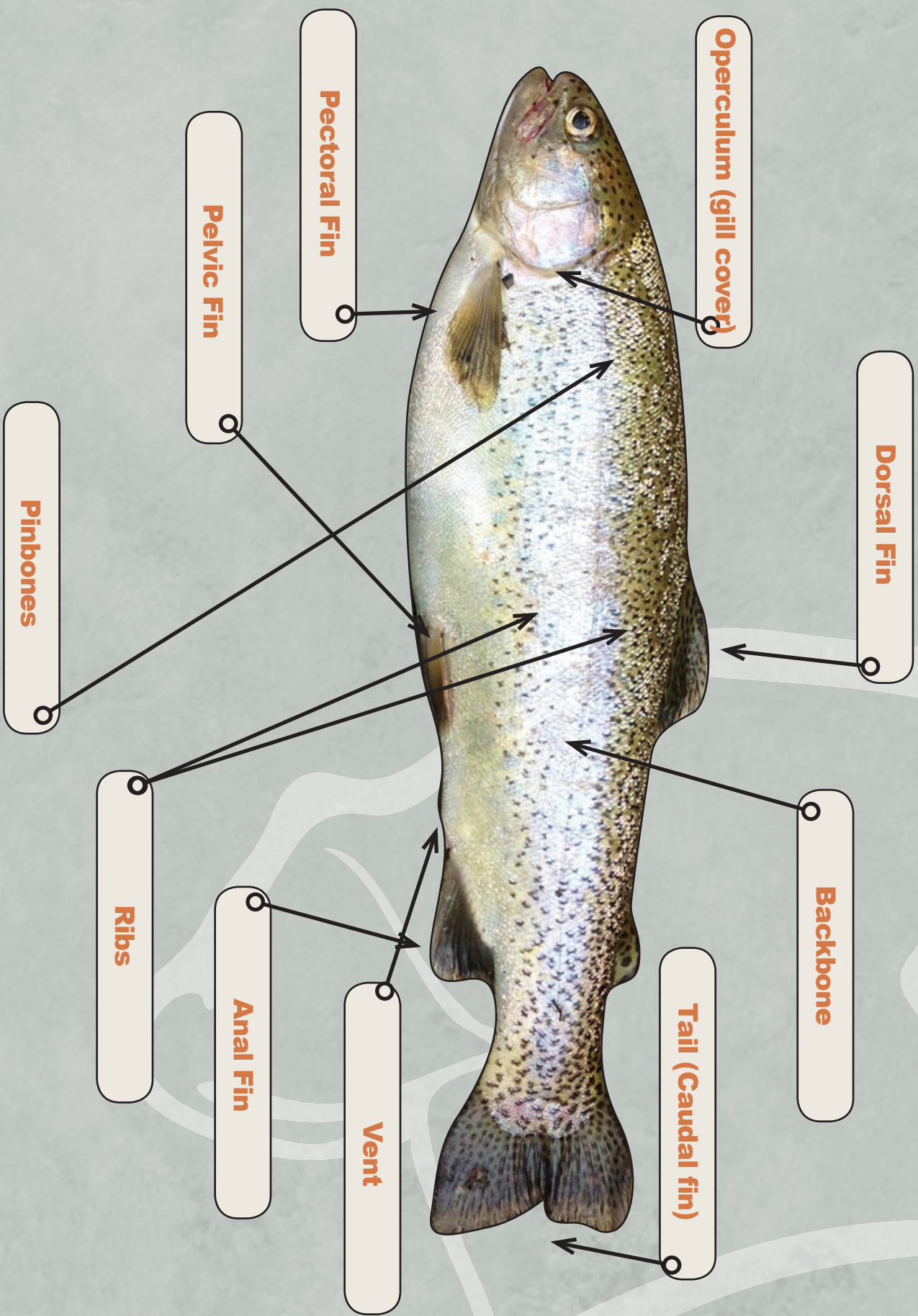

LESSON PLAN - ROUND FISH, FLAT FISH, MOLLUSKS & CRUSTACEANS STUDY BOOKLET



From the kitchen of **SEAFOOD COOKERY**

■ Purpose and Practice:

- Reading material previously studied in class and remembering the parts of a round fish and what makes them different from a round fish.

■ Ingredients

Pages 286 to 297
(learners' study book)

■ Method

- Instructor prepares full sets of booklets for each learner
- Instructor prepares one set of each booklet per group
- The class is divided into 4 groups and the instructor assigns a different booklet to each group (draw from a hat)
- Instructor invites each group to create a "learning poster" for their peers
- Each group works on their booklet to create a visual poster to be presented to their peers.
- Each group presents their poster to the whole class.
- Instructor provides a full booklet to each learner for study purposes.
- Posters can be displayed in the classroom.

■ Cooking Time

2 - 3 Hours

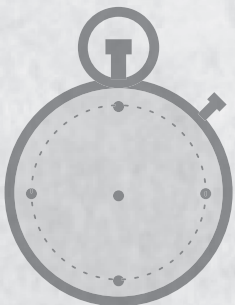

■ Essential Skills being practiced

- ✓ Thinking Skills
- ✓ Document Use
- ✓ Working with Others

Tip:

*Invite learners to review each others' posters over the course of the training for study purposes.
Remove the posters from the classroom during test time.*

ROUND FISH - IMAGES AND DESCRIPTION



Round Fish

- swim in a vertical position
- have eyes on both sides of their heads
- bodies may be round, oval or compressed



Bass

- varieties include: largemouth, smallmouth, redeye and black
 - members of the sunfish family
 - lean and delicate
- salt water varieties (black sea and striped) are popular commercial items



Catfish

- scaleless freshwater fish
- common in southern lakes and rivers
- now aquafarmed which eliminates the “muddy” taste
- flesh is pure white with a moderate fat content
- mild, sweet flavour and firm texture
- especially well suited for frying



Artic Char

- a type of salmon found in far northern rivers
- lean and pink fleshed

ROUND FISH - IMAGES AND DESCRIPTION (CON'T)**Cod**

- family includes Atlantic and Pacific varieties as well as Pollock, haddock, whiting and hake
- mild, delicate flavour and lean, firm white flesh that flakes apart easily
- can be prepared by most cooking methods, although grilling is not recommended because the flesh is too flaky

**Pacific Cod**

- also known as grey cod
- found in the northern Pacific Ocean
- not as abundant as Atlantic cousin
- most often available frozen
- known as “true cod”

**Red Snapper**

- the true variety has lean, pink flesh that becomes white when cooked
- sweet flavoured and flaky
- sold whole or as fillets with the skin left on for identification
- can be prepared using almost any cooking method
- head and bones are excellent for stock

**Atlantic Salmon**

- most important commercial fish
- lots of aquafarms in Canada, Norway and Scotland so there is a steady supply
- this fish's point of origin is often added to the name
- have a rich pink colour
- average weight 4 to 12 lb.
- Wild variety are almost never available

ROUND FISH - IMAGES AND DESCRIPTION (CON'T)



Chinook (King) Salmon

- from the Pacific
- red-orange flesh
- flesh separates into large flakes when cooked
- high fat content
- average weight 5 to 30 lb.
- Often marketed by the name of the river from which they are harvested
- The interior of their mouths are black



Coho (Silver) Salmon

- pinkish flesh
- available fresh or frozen, wild or aquafarmed
- wild average 3 to 12 lb.
- Aquafarmed average 1 pound



Tilapia

- name given to several species of freshwater, aquafarm-raised fish bred across the world
- they grow quickly in warm water
- up to 3 lb
- flesh is similar to catfish: lean, white meat and sweet with a firm texture

ROUND FISH - IMAGES AND DESCRIPTION (CON'T)



Trout

- varieties include rainbow, brown and brook
- on the West Coast they are called salmon trout or steelhead
- have low to moderate fat content
- flaky texture and delicate flavour
- flesh may be white, orange or pink
- can be baked, pan-fried, smoked or steamed



Tuna

- varieties include the bluefin, yellowfin, bonito, bigeye and blackfin
- Ahi is the popular market name for either yellowfin or bigeye
- Members of the mackerel family
- Found in tropical and sub-tropical waters around the world
- Large fish weighing up to several hundred pounds each

FLAT FISH - IMAGES AND DESCRIPTION**Flat Fish**

- swim in a horizontal position
- have both eyes on the top of their heads
- have asymmetrical (uneven) or compressed bodies
- bottom dwellers, usually in deep ocean waters
- skin on top of body is dark for camouflage
- can change color depending on surroundings
- scales are small and dorsal and anal fins run the length of their bodies

**Flounder**

- have lean, firm flesh that is pearly or pinkish-white
- sweet, mild flavour
- usually sold as fresh or frozen fillets
- fillets are very thin and dry out or spoil easily
- best for poaching, steaming or frying

**English Sole**

- usually marketed as "fillet of sole"
- actually flounder caught off the west coast of Canada

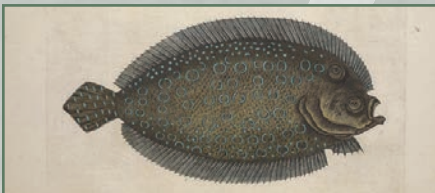
**Domestic Dover Sole**

- Pacific flounder
- Not as delicate or flavourful as other species of sole or flounder
- Often afflicted with a parasite that causes meat to have a slimy, jelly like texture
- Not recommended if another sole or flounder are available

FLAT FISH - IMAGES AND DESCRIPTION (CON'T)

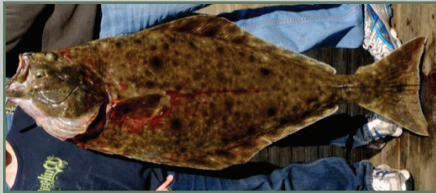

Halibut

- among the largest of flat fish
- can weigh up to 300 lb (135 kg)
- have lean, firm flesh that is snow-white
- sweet, mild flavour
- flesh dries out easily
- can be poached, baked, grilled or broiled and is good with many sauces



Turbot

- type of Pacific flat fish, not particularly popular in Canada
- in Europe, the species are large diamond-shaped and popular because of their delicate flavour and firm, white flesh
- also marketed as “brill” and the Japanese sell it for fine dining

MOLLUSKS - IMAGES AND DESCRIPTION**Mollusks**

Mollusks are shellfish that have a soft body, no internal skeleton and a hard outside shell.

Univalves are mollusks with a single shell in which the soft-bodied animal lives. They are marine snails with a single foot, used to attach the creature to fixed objects such as rocks.

**Abalone**

- have brownish-grey, ear-shaped shells
- lean with a sweet delicate flavour similar to clams
- tough to eat unless tenderized with a mallet
- can be eaten raw or seviche-style
- meat becomes tough if overcooked

Bivalves are mollusks with two bilateral shells attached by a central hinge.

**Clams**

- harvested along the east and west Coasts
- available all year, live in the shell or shucked (meat removed from the shell)
- also available canned (minced, chopped or whole)

**Atlantic Hard Shelled Clams – Quahogs**

- have hard blue-grey shells
- meat is chewy and not as sweet as other clams
- they have different names depending on their size (Littlenecks, Cherrystones and Topnecks)

MOLLUSKS - IMAGES AND DESCRIPTION (CON'T)**Littlenecks**

- generally measure under 2 in. (5 cm) across the shell
- usually served on the half shell or steamed
- they are the most expensive clams

**Cherrystones**

- generally under 3 in (7.5 cm) across the shell
- sometimes eaten raw but most often cooked

**Topneck Clams**

- usually cooked and are often served as stuffed clams

**Soft-shell Clams**

- also known as Ipswich, steamer and long-necked clams
- have thin, brittle shells that do not close because of black-tipped siphon
- meat is tender and sweet
- sometimes fried but mostly steamed

**Pacific Clams**

- generally too tough to eat raw
- most common is the Manila clam
- resembles a quahog with a ridged shell
- can be served steamed or on the half shell

MOLLUSKS - IMAGES AND DESCRIPTION (CON'T)



Mussels

- excellent steamed in wine or seasoned broth
- can be fried or used in soups or pasta dishes



Oysters

- have a rough grey shell
- soft, grey, briny flesh can be eaten raw or cooked
- four main species: Atlantic, European flat, Olympias and Pacific

CRUSTACEANS - IMAGES AND DESCRIPTION**Crustaceans**

Crustaceans are found in both fresh and salt water. They have a hard outer shell and jointed appendages, and they breathe through gills.

**Crabs**

- found along the North American coasts
- shipped through the world in fresh, frozen and canned forms
- meat varies in flavour and texture
- used in chowders, curries, casseroles
- purchased live, they should last up to five days

**King Crabs**

- very large, usually around 10 lb. (4.5 kg)
- caught in the very cold waters of the North Pacific
- meat is very sweet and snow-white
- always sold frozen, usually in the shell

**Dungeness Crabs**

- found along the West Coast
- weigh 1.5 to 4 lb
- have delicate, sweet meat
- sold live, pre-cooked and frozen or as picked meat

CRUSTACEANS - IMAGES AND DESCRIPTION (CON'T)



Lobsters

- brown to blue-black outer shells
- firm, white meat with a rich, sweet flavour
- shells turn red when cooked
- usually poached, steamed, simmered, baked or grilled
- can be served cold
- must be kept alive until just before cooking



Atlantic Lobster

- have edible meat in both their tails and claws
- considered superior to all others
- come from the cold waters along the northeast coast
- most often sold live

CRUSTACEANS - IMAGES AND DESCRIPTION (CON'T)

■ Domestic Lobster





MEAT & POULTRY COOKERY



LESSON PLAN - DRY-HEAT COOKING METHODS FOR MEATS – FILL IN THE BLANKS

From the kitchen of MEAT & POULTRY COOKERY

Purpose and Practice:

- Reading material previously studied in class and remembering what was learned.

Ingredients

Page 300 (learners' handout)
Page 301 (instructor's answer key)

Method

- Instructor prepares appropriate number of "Dry-heat Cooking Methods for Meats" handouts for the learners
Individually, learners fill in the banks using the words provided to complete the passage.
Instructor reviews the answers with the class in a group setting

Cooking Time

10 - 15 minutes

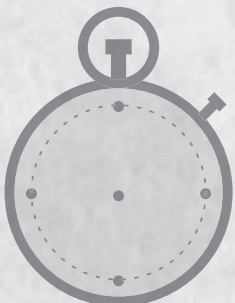

Essential Skills being practiced

- Reading Text
Thinking Skills
Writing
Document Use

Tip:

DRY-HEAT COOKING METHODS FOR MEATS - EXERCISE

Dry-heat cooking is the method used to roast, broil, grill, sauté and/or pan-fry foods. Dry-heat means heat is conducted by hot air, hot metal, radiation or hot fat. When cooking with dry-heat, no extra liquid is added to the food during preparation and the cooking item is seldom covered. Use the following words to fill in the blanks in the sentences below on roasting meat.

fat side up**brown****dry****yield****self-baste****seared****juicy****quality****temperature****Roasting Meat:**

The goal of roasting with dry-heat is to have the surface of the meat _____ without charring, while the centre of the cut remains _____ and succulent.

To prevent the meat from becoming _____ during the roasting process, the cut of meat is sometimes _____ and is almost always placed on the rack _____ so it can _____.

Dry roasting is a suitable cooking procedure only for fine or _____ meats.

Timing and _____ are very important to prevent shrinkage and loss of _____.

DRY-HEAT COOKING METHODS FOR MEATS - ANSWERS

Dry-heat cooking is the method used to roast, broil, grill, sauté and/or pan-fry foods. Dry-heat means heat is conducted by hot air, hot metal, radiation or hot fat. When cooking with dry-heat, no extra liquid is added to the food during preparation and the cooking item is seldom covered. Use the following words to fill in the blanks in the sentences below on roasting meat.

fat side up	brown	dry	yield
self-baste	seared	juicy	quality
temperature			

Roasting Meat:

The goal of roasting with dry-heat is to have the surface of the meat brown without charring, while the centre of the cut remains juicy and succulent.

To prevent the meat from becoming dry during the roasting process, the cut of meat is sometimes seared and is almost always placed on the rack fat side up so it can self-baste.

Dry roasting is a suitable cooking procedure only for fine or quality meats.

Timing and temperature are very important to prevent shrinkage and loss of yield.



**LESSON PLAN - ROASTING EQUIPMENT –
FILL IN THE BLANKS**

From the kitchen of **MEAT & POULTRY COOKERY**

■ Purpose and Practice:

- Reading material previously studied in class and remembering what was learned.

■ Ingredients

Page 303
(learners' handout)

Page 304
(instructor's answer
key)

■ Method

- Instructor prepares appropriate number of "Roasting Equipment" handouts for the learners
- Individually, learners fill in the banks using the words provided to complete the passage.
- Instructor reviews the answers with the class in a group setting

■ Cooking Time

10 - 15 minutes

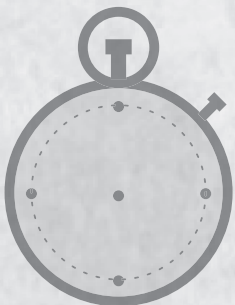

■ Essential Skills being practiced

- ✓ Reading Text
- ✓ Thinking Skills
- ✓ Writing
- ✓ Document Use

Tip:



ROASTING EQUIPMENT - EXERCISE

Dry-heat cooking is the method used to roast, broil, grill, sauté and/or pan-fry foods. Dry-heat means heat is conducted by hot air, hot metal, radiation or hot fat. When cooking with dry-heat, no extra liquid is added to the food during preparation and the cooking item is seldom covered. Use the following words to fill in the blanks in the sentences below on roasting equipment.

dryness**shrinking****ovens****hot air****fans****Roasting Equipment:**

In commercial convection _____, the hot air is moved mechanically by _____.

Care must be taken as the movement of the _____ in the oven can cause excessive _____, overbrowning and _____ in the cooked meat.

ROASTING EQUIPMENT - ANSWERS

Dry-heat cooking is the method used to roast, broil, grill, sauté and/or pan-fry foods. Dry-heat means heat is conducted by hot air, hot metal, radiation or hot fat. When cooking with dry-heat, no extra liquid is added to the food during preparation and the cooking item is seldom covered. Use the following words to fill in the blanks in the sentences below on roasting equipment.

dryness**shrinking****ovens****hot air****fans****Roasting Equipment:**

In commercial convection ovens, the hot air is moved mechanically by fans.

Care must be taken as the movement of the hot air in the oven can cause excessive shrinking, overbrowning and dryness in the cooked meat.



LESSON PLAN - ROASTING MEAT IN THE OVEN

From the kitchen of **MEAT & POULTRY COOKERY**

Purpose and Practice:

- To review key points about roasting meat in the oven

Ingredients

Page 307
Study Sheet

Page 308
Activity set

Page 309
Activity set
Answers

Method

- Instructor prepares appropriate number of sets of study sheets and activity question sheets
- Individually, learners review the information and answer the activity set questions
- Review answers together as a group using the answer key as a reference

Cooking Time

25 minutes

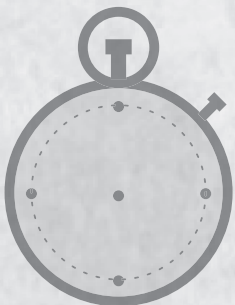

Essential Skills being practiced

- ✓ Writing
- ✓ Oral Communication
- ✓ Document Use
- ✓ Reading Text

Tip:

Learners may be given the opportunity to examine meat thermometer and the difference between Celsius and Fahrenheit)

ROASTING MEAT IN THE OVEN

When roasting meat in the oven, the following points should be observed:

1. Bring meat to room temperature before roasting.
2. Season the meat lightly. Follow the guidelines of your school regarding pre-seasoning procedures.
3. Place roast fat side up on a rack in a suitable roasting pan to retain the fat and meat juices.
4. Insert a meat thermometer in the meat so that the probe is in the centre of the meat. The thermometer should not touch bone or fat.
5. Do not cover and do not add liquids.
6. Place pan in a preheated oven 135^o to 220^o Celsius (275^o to 425^o Fahrenheit).
7. Baste frequently with the melted fat only.
8. Add mirepoix to the roasting pan halfway through the cooking process.
9. Remove the roast from the oven when the thermometer registers 6-8^o Celsius (10-15^o Fahrenheit) below the degree of doneness. This will allow for the carry over cooking. Removing the roast from the oven does not halt the cooking process immediately. The heat that is contained inside the roast will continue to cook the roast. This is called carry over cooking.
10. Allow the meat to sit before carving. By waiting about ½ hour before carving, you allow the juices in the meat to be redistributed throughout the cut which reduces juice losses and dryness in the meat. Do not keep meat at room temperature longer than 2 hours.

ROASTING MEAT IN THE OVEN - ACTIVITY SET

1. What temperature should meat be at before roasting?

2. Why should a roast be placed fat side up on a rack in a roasting pan?

3. When inserting a meat thermometer, where should the probe be?

4. What is added to the roasting pan halfway through the cooking process?

5. Why is a roast removed from the oven a few degrees below the degree of doneness?

6. Why do you wait about ½ hour before carving the roast?

7. How long can a cooked roast be left at room temperature?

ROASTING MEAT IN THE OVEN - ACTIVITY SET - ANSWERS

1. What temperature should meat be at before roasting?

Room temperature

2. Why should a roast be placed fat side up on a rack in a roasting pan?

To retain the fat and meat juices

3. When inserting a meat thermometer, where should the probe be?

In the centre of the meat (not touching bone or fat)

4. What is added to the roasting pan halfway through the cooking process?

Mirepoix

5. Why is a roast removed from the oven a few degrees below the degree of doneness?

To allow to carry over cooking

6. Why do you wait about ½ hour before carving the roast?

To allow the juices in the meat to be redistributed through the cut (reduces juice loss and dryness)

7. How long can a cooked roast be left at room temperature?

No longer than 2 hours



**LESSON PLAN - JUS AND GRAVIES –
FILL IN THE BLANKS**

From the kitchen of **MEAT & POULTRY COOKERY**

■ Purpose and Practice:

- Reading material previously studied in class and remembering what was learned.

■ Ingredients

Page 310
(learners' handout)

Page 311
(instructor's answer
key)

■ Method

- Instructor prepares appropriate number of "Jus and Gravies" handouts for the learners
- Individually, learners fill in the banks using the words provided to complete the passage.
- Instructor reviews the answers with the class in a group setting

■ Cooking Time

10 - 15 minutes

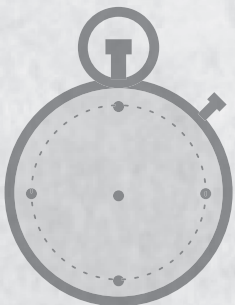

■ Essential Skills being practiced

- ✓ Reading Text
- ✓ Thinking Skills
- ✓ Writing
- ✓ Document Use

Tip:



JUS & GRAVIES - ACTIVITY SET

Using the following vocabulary words, complete the sentences below by inserting the best possible word:

cornstarch

mirepoix

gravy

juice

cleaner

flavour

Roasted meat is served with its own _____, called jus, or a _____.

Gravies and jus must always be of the same _____ as the meat that they accompany.

Jus refers to the natural juices of a meat that has been roasted with _____ and seasonings. It is usually very lightly thickened with _____ or arrowroot starch for a _____ finished product and called jus lié.

JUS & GRAVIES - ACTIVITY SET - ANSWERS

Using the following vocabulary words, complete the sentences below by inserting the best possible word:

cornstarch

mirepoix

gravy

juice

cleaner

flavour

Roasted meat is served with its own juice, called jus, or a gravy.

Gravies and jus must always be of the same flavour as the meat that they accompany.

Jus refers to the natural juices of a meat that has been roasted with mirepoix and seasonings. It is usually very lightly thickened with cornstarch or arrowroot starch for a cleaner finished product and called jus lié.

LESSON PLAN - JUS LIÉ – 7 STEPS FOR PREPARING JUS LIÉ

From the kitchen of **MEAT & POULTRY COOKERY****■ Purpose and Practice:**

- Learner`s will review the 7 steps for preparing jus lié and then practice arranging the 7 steps in order.

■ Ingredients

Page 313
(learners' handout)

Page 314
(4 sets of the seven
steps strips, color
coded)

■ Method

- Instructor prepares up to 4 sets by color code (depending on class size), of the Jus lié steps strips and shuffles each set so that they are not in order.
- Working in small groups, the learners arrange the Jus lié steps strips in order (Step 1: Remove roast from pan and keep warm, Step 2: ...)
- Instructor roams around and encourages the small groups
- Once the exercise is finished, invite the learners to walk around each set to see if they came up with the same order.

■ Cooking Time

15 - 20 minutes

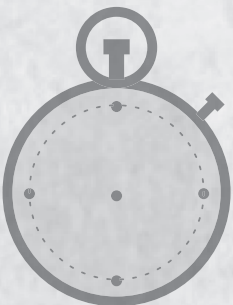
**■ Essential Skills being practiced**

- ✓ Reading Text
- ✓ Thinking Skills
- ✓ Writing
- ✓ Document Use

Tip:

Instructor may wish to review some of the vocabulary and invite learners to describe the meaning of terms such as ``reduce, deglaze, simmer, seasoning, etc.``

Note: sets are color coded so that they do not get mixed up when collecting after the exercise.

JUS LIÉ

There are 7 steps for preparing jus lié:

1. Remove roast from pan and keep warm.
2. Place pan on top of the stove and reduce the meat juices until they stick on the bottom of the pan. This will provide a concentrated flavour, and a natural rich dark color. Do not burn the pan!
3. Pour off all the fat to prevent greasy jus.
4. Deglaze pan with stock, and some wine if desired. Scrape all the brown particles from the bottom and simmer for 30 minutes.
5. Thicken very lightly with starch mixed with liquid.
6. Check seasoning and consistency.
7. Strain through cheesecloth or a china cap and hold for service.

JUS LIÉ - EXERCISE

There are 7 steps for preparing jus lié. In your groups, arrange the steps in order.
(note: the Instructor will have cut steps into strips, and shuffle them prior to groups arranging them in order)



Remove roast from pan and keep warm.



Place pan on top of the stove and reduce the meat juices until they stick on the bottom of the pan. This will provide a concentrated flavour, and a natural rich dark color. Do not burn the pan!



Pour off all the fat to prevent greasy jus.



Deglaze pan with stock, and some wine if desired. Scrape all the brown particles from the bottom and simmer for 30 minutes.



Thicken very lightly with starch mixed with liquid.



Check seasoning and consistency.



Strain through cheesecloth or a china cap and hold for service.



LESSON PLAN - BROILING MEAT – FILL IN THE BLANKS

From the kitchen of **MEAT & POULTRY COOKERY**

Purpose and Practice:

- Reading material previously studied in class and remembering what was learned.

Ingredients

Page 316
(learners' handout)

Page 317
(instructor's answer key)

Method

- Instructor prepares appropriate number of "Broiling Meat" handouts for the learners
- Individually, learners fill in the banks using the words provided to complete the passage.
- Instructor reviews the answers with the class in a group setting

Cooking Time

10 - 15 minutes

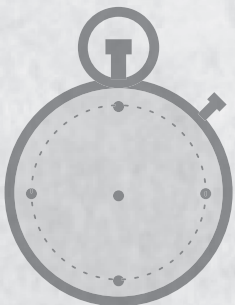

Essential Skills being practiced

- ✓ Reading Text
- ✓ Thinking Skills
- ✓ Writing
- ✓ Document Use

Tip:

The "fill in the blanks" exercises can be distributed to learner's that finish group activities ahead of others. They may also be assigned as homework for those who did not get to work with them during class time.

BROILING MEAT - ACTIVITY SET

Using the following vocabulary words, complete the sentences below by inserting the best possible word:

heat source**inside****broilers****sears****above****juices**

Broiling is an efficient high heat cooking process that quickly _____ the food on the outside and then allows the food to be cooked on the _____ by its own _____.

Some commercial _____ have the radiant _____ placed below the cooking surface, others have the heat source _____, and yet others can heat from above and below.

BROILING MEAT - ACTIVITY SET - ANSWERS

Using the following vocabulary words, complete the sentences below by inserting the best possible word:

heat source**inside****broilers****sears****above****juices**

Broiling is an efficient high heat cooking process that quickly sears the food on the outside and then allows the food to be cooked on the inside by its own juices.

Some commercial ovens have the radiant heat source placed below the cooking surface, others have the heat source above, and yet others can heat from above and below.



LESSON PLAN - CHAR-BROILING MEATS – 6 STEPS FOR CHAR-BROILING MEATS

From the kitchen of **MEAT & POULTRY COOKERY**

■ Purpose and Practice:

- Learner`s will review the 6 steps for char-broiling meats and then practice arranging the 6 steps in order.

■ Ingredients

Page 319
(learners' handout)

Page 320
(4 sets of the seven
steps strips, color
coded)

■ Method

- Instructor prepares up to 4 sets by color code (depending on class size), of the Char-broiling Meats steps strips and shuffles each set so that they are not in order.
- Working in small groups, the learners arrange the Char-broiling Meats steps strips in order (Step 1: Remove roast from the pan, Step 2: ...)
- Instructor roams around and encourages the small groups
- Once the exercise is finished, invite the learners to walk around each set to see if they came up with the same order.

■ Cooking Time

15 - 20 minutes

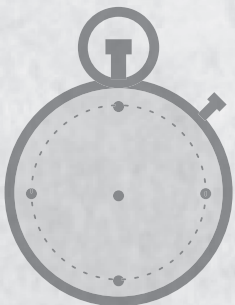

■ Essential Skills being practiced

- ✓ Reading Text
- ✓ Thinking Skills
- ✓ Writing
- ✓ Document Use

Tip:

Instructor may wish to review some of the vocabulary and invite learners to describe the meaning of terms such as ``char-broiling, recipe, wire brush, tongs, etc.``

Note: sets are color coded so that they do not get mixed up when collecting them after the exercise.

CHAR-BROILING MEATS

There are 6 steps for char-broiling meats:

1. Turn heat on the char-broiler to full and allow it to become very hot.
2. Prepare the meat and the recipe requires.
3. Brush char-broiler with wire brush and clean with oil.
4. Season and lightly oil the meat to be char-broiled.
Place on the char broiler.
5. When the juices appear on surface of the meat, turn to cook
and mark meat evenly on each side.
6. Use tongs to handle char-broiled food.

CHAR-BROILING MEATS - EXERCISE

There are 6 steps for char-broiling meat. In your groups, arrange the steps in order.
(note: the Instructor will have cut steps into strips, and shuffle them prior to groups arranging them in order)



Turn heat on the char-broiler to full and allow it to become very hot.



Prepare the meat and the recipe requires.



Brush char-broiler with wire brush and clean with oil.



Season and lightly oil the meat to be char-broiled.
Place on the char broiler.



When the juices appear on surface of the meat, turn to cook and mark meat evenly on each side.



Use tongs to handle char-broiled food.

LESSON PLAN - DETERMINING DONENESS CHAR-BROILED MEATS: READING COMPREHENSION EXERCISE



From the kitchen of **MEAT & POULTRY COOKERY**

■ Purpose and Practice:

- Reading and comprehension practice.

■ Ingredients

Page 322
(learners' handout)

Page 323
(Activity Set)

Page 324
(Instructor Answer Key)

■ Method

- Instructor prepares appropriate number of "Determining Doneness for Char-broiled Meats" handouts and activity sets for the learners
- Individually, or in small groups, learners read the method for determining degree of doneness.
- Instructor reviews the answers with the class in a group setting

■ Cooking Time

15 - 20 minutes

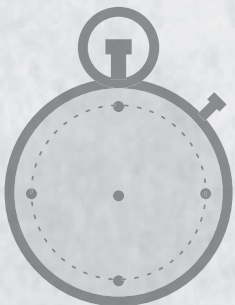

■ Essential Skills being practiced

- ✓ Reading Text
- ✓ Thinking Skills
- ✓ Writing
- ✓ Working with Others

(if activity is done in a small group setting)

Tip:



DETERMINING DONENESS FOR CHAR-BROILED MEATS

Method for determining degree of doneness:

The test for determining the degree of doneness for char-broiled meat is to apply light pressure with the fingers, tongs or spatula to the centre of the meat. The springier or softer the meat, the more rare it is. The firmer the flesh, the more the meat will be well-cooked.

This touch method of determining doneness takes practice and must be mastered in order to become a professional broiler cook.

Do not use a fork or needle to make a hole in a broiled piece of meat as this will allow the juices that have been so carefully sealed inside by the broiling process to escape.

DETERMINING DONENESS FOR CHAR-BROILED MEATS - ACTIVITY SET

1. In your own words, describe the test for determining the degree of doneness for char-broiled meats.

2. If meat is springy or soft to the touch, how is the meat?

3. What does it take to become a professional broiler cook?

4. Why shouldn't you use a fork or needle to make a hole in a broiled piece of meat?

DETERMINING DONENESS FOR CHAR-BROILED MEATS - ANSWERS

1. In your own words, describe the test for determining the degree of doneness for char-broiled meats.

Apply light pressure with fingers, tongs or a spatula and press lightly on

the centre of the meat.

2. If meat is springy or soft to the touch, how is the meat?

The meat will be rarer.

3. What does it take to become a professional broiler cook?

Practice

4. Why shouldn't you use a fork or needle to make a hole in a broiled piece of meat?

because the hole will let the juices escape.



**LESSON PLAN - GRIDDLING MEATS –
6 STEPS FOR GRIDDLING MEATS**

From the kitchen of **MEAT & POULTRY COOKERY**

■ Purpose and Practice:

- Learner`s will review the 6 steps for griddling meats and then practice arranging the 6 steps in order.

■ Ingredients

Page 326
(learners' handout)

Pages 327
(4 sets of the seven
steps strips, color
coded)

■ Method

- Instructor prepares up to 4 sets by color code (depending on class size), of the Griddling Meats steps strips and shuffles each set so that they are not in order.
- Working in small groups, the learners arrange the Griddling Meats steps strips in order (Step 1: Remove roast from the pan, Step 2: ...)
- Instructor roams around and encourages the small groups
- Once the exercise is finished, invite the learners to walk around each set to see if they came up with the same order.

■ Cooking Time

15 - 20 minutes

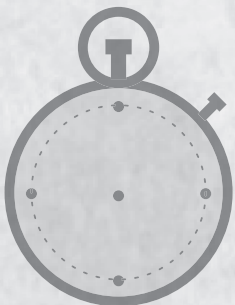

■ Essential Skills being practiced

- ✓ Reading Text
- ✓ Thinking Skills
- ✓ Document Use
- ✓ Working with Others

Tip:

Instructor may wish to review some of the vocabulary and invite learners to describe the meaning of terms such as ``char-broiling, recipe, wire brush, tongs, etc.``

Note: sets are color coded so that they do not get mixed up when collecting them after the exercise.

GRIDDLING MEATS

Griddling is done on a solid cooking surface above a heat source. This piece of equipment is sometimes referred to as a flat top. Below please find the general procedures for griddling:

1. Collect all equipment and food supplies. For example, an offset spatula is needed for turning food.
2. Prepare meats. This may include seasoning, breading or dredging with flour.
3. Preheat grill and add fat to the hot surface. The amount depends on the item cooked. Breaded food items require more fat; steaks require only a very thin film of fat.
4. Place the food on the griddle.
5. Brown the meat on one side. Turn it with a spatula and brown the other side. Larger pieces may need to be finished at reduced heat or in an oven, after browning.
6. Serve immediately, with appropriate sauce and/or garnish

GRIDDLING MEATS - GROUP SORT EXERCISE

Working in groups, sort the order of the process for griddling meat.

(note: Instructor will have prepared sets by cutting the steps into strips and shuffling them)



Collect all equipment and food supplies. For example, an offset spatula is needed for turning food.



Prepare meats. This may include seasoning, breading or dredging with flour.



Preheat grill and add fat to the hot surface. The amount depends on the item cooked. Breaded food items require more fat; steaks require only a very thin film of fat.



Place the food on the griddle.



Brown the meat on one side. Turn it with a spatula and brown the other side. Larger pieces may need to be finished at reduced heat or in an oven, after browning.



Serve immediately, with appropriate sauce and/or garnish.

LESSON PLAN - SAUTÉING - 6 GENERAL PROCEDURES FOR SAUTÉING



From the kitchen of **MEAT & POULTRY COOKERY**

■ Purpose and Practice:

- Learner`s will review the 6 general steps for sautéing and then practice arranging the 6 steps in order.

■ Ingredients

Page 329
(learners' handout)

Pages 330
(4 sets of the seven steps strips, color coded)

■ Method

- Instructor prepares up to 4 sets by color code (depending on class size), of the Sautéing steps strips and shuffles each set so that they are not in order.
- Working in small groups, the learners arrange the Sautéing steps strips in order (Step 1: Remove roast from the pan, Step 2: ...)
- Instructor roams around and encourages the small groups
- Once the exercise is finished, invite the learners to walk around each set to see if they came up with the same order.

■ Cooking Time

15 - 20 minutes

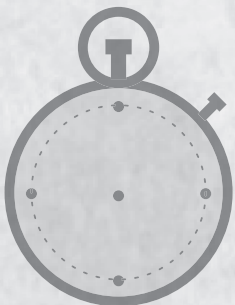

■ Essential Skills being practiced

- ✓ Reading Text
- ✓ Thinking Skills
- ✓ Document Use
- ✓ Working with Others

Tip:

Tip: Instructor may wish to review some of the vocabulary and invite learners to describe the meaning of terms such as `tender cuts, dredging, flipping, tossing, drain, etc.

Note: sets are color coded so that they do not get mixed up when collecting them after the exercise.

SAUTÉING

Sautéing and pan-frying are similar. Sautéing is designed to cook small, tender cuts of food by using high heat and a small amount of fat. Below please find the general procedures for sautéing:

1. Assemble all the equipment and food.
2. Prepare meats as required. This may mean patting the meat dry and dredging in flour. Seasoning is usually done after browning.
3. Heat a small amount of fat in a sauté pan until very hot.
4. Add the meat to the pan. Do not overcrowd the pan as this will cause the temperature to drop and make the meat simmer rather than sauté.
5. Brown the meat on all sides, flipping or tossing it in the pan as necessary.
6. Season the meat and remove from pan. Drain excess fat if any. Deglaze the pan with stock, wine or other liquid to dissolve the browned bits of food sticking to the bottom. Finish the sauce according to the recipe.

SAUTÉING - GROUP SORT EXERCISE

Working in groups, sort the process for sautéing by steps.

(note: the instructor prepares sets by cutting the steps into strips and shuffling them)



Assemble all the equipment and food.



Prepare meats as required. This may mean patting the meat dry and dredging in flour. Seasoning is usually done after browning.

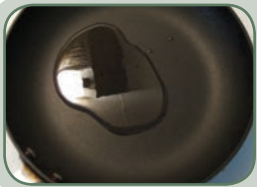

Heat a small amount of fat in a sauté pan until very hot.



Add the meat to the pan. Do not overcrowd the pan as this will cause the temperature to drop and make the meat simmer rather than sauté.



Brown the meat on all sides, flipping or tossing it in the pan as necessary.



Season the meat and remove from pan. Drain excess fat if any. Deglaze the pan with stock, wine or other liquid to dissolve the browned bits of food sticking to the bottom. Finish the sauce according to the recipe.



**LESSON PLAN - PAN FRYING -
FILL IN THE BLANKS**

From the kitchen of **MEAT & POULTRY COOKERY**

■ Purpose and Practice:

- Reading material previously studied in class and remembering what was learned.

■ Ingredients

Page 332
(learners' handout)

Page 333
(instructor's answer
key)

■ Method

- Instructor prepares appropriate number of "Pan Frying" handouts for the learners
- Individually, learners fill in the blanks using the words provided to complete the passage.
- Instructor reviews the answers with the class in a group setting

■ Cooking Time

15 - 20 minutes



■ Essential Skills being practiced

- ✓ Reading Text
- ✓ Thinking Skills
- ✓ Writing
- ✓ Document Use

Tip:

The "fill in the blanks" exercises can be distributed to learners who finish group activities ahead of others. They may also be assigned as homework for those who did not get to work with them during class time.

PAN FRYING - EXERCISE

Using the following vocabulary words, complete the sentences below by inserting the best possible word:

sauces**lower****irregularly****removed****to the side****fat****flat****once****larger****browning**

This procedure differs from sautéing because of the amount of _____ used. Pan-frying is used for _____ pieces of food, such as chops and chicken pieces and is usually done over _____ heat.

The amount of fat used depends on the food being cooked. Only a small amount is used for _____ items, while as much as an inch or more may be used for _____ shaped or thicker items. Most foods must be turned at least _____ for even cooking.

Some larger foods may be _____ from the pan and finished in the oven to prevent excessive surface _____.

Items that are breaded before pan-frying are often served without _____ or gravies.

However, if a gravy is served with a breaded entrée, the gravy must be placed under the meat or _____.

PAN FRYING - ANSWERS

Using the following vocabulary words, complete the sentences below by inserting the best possible word:

saucés	lower	irregularly	removed	to the side
fat	flat	once	larger	browning

This procedure differs from sautéing because of the amount of fat used. Pan-frying is used for larger pieces of food, such as chops and chicken pieces and is usually done over lower heat.

The amount of fat used depends on the food being cooked. Only a small amount is used for flat items, while as much as an inch or more may be used for irregularly shaped or thicker items. Most foods must be turned at least once for even cooking. Some larger foods may be removed from the pan and finished in the oven to prevent excessive surface browning.

Items that are breaded before pan-frying are often served without saucés or gravies. However, if a gravy is served with a breaded entrée, the gravy must be placed under the meat or to the side.

**LESSON PLAN - DRY-HEAT COOKING METHODS FOR POULTRY
- FILL IN THE BLANKS**



From the kitchen of **MEAT & POULTRY COOKERY**

■ Purpose and Practice:

- Reading material previously studied in class and remembering what was learned.

■ Ingredients

Page 335
(learners' handout)

Page 336
(instructor's answer key)

■ Method

- Instructor prepares appropriate number of "Dry-heat Cooking Methods for Poultry" handouts for the learners.
- Individually, learners fill in the banks using the words provided to complete the passage.
- Instructor reviews the answers with the class in a group setting.

■ Cooking Time

10 - 15 minutes



■ Essential Skills being practiced

- ✓ Reading Text
- ✓ Thinking Skills
- ✓ Writing
- ✓ Document Use

Tip:

The "fill in the blanks" exercises can be distributed to learners who finish group activities ahead of others. They may also be assigned as homework for those who did not get to work with them during class time.

DRY-HEAT COOKING METHODS FOR POULTRY - EXERCISE

Poultry can be prepared using dry-heat cooking methods. Like meat, poultry can be roasted, grilled, broiled, sautéed and pan-fried. Poultry can also be deep-fried which is considered a dry-heat cooking method. Please complete the sentences below by inserting the most appropriate words.

age**breast****drumsticks****tougher****faster****thighs****wings****cooking process**

The light meat is taken from the _____ and _____, and the dark meat from the _____ and _____. Because white meat has less fat and connective tissue than dark meat, it cooks _____ and can become dry and stringy if care is not taken during the _____.

The older the poultry muscle, the _____ it will be. Consequently, cooking methods depend on the _____ of the bird when it was butchered.

DRY-HEAT COOKING METHODS FOR POULTRY - ANSWERS

Poultry can be prepared using dry-heat cooking methods. Like meat, poultry can be roasted, grilled, broiled, sautéed and pan-fried. Poultry can also be deep-fried which is considered a dry-heat cooking method. Please complete the sentences below by inserting the most appropriate words.

age**breast****drumsticks****tougher****faster****thighs****wings****cooking process**

The light meat is taken from the **breast** and **wings**, and the dark meat from the **thighs** and **drumsticks**. Because white meat has less fat and connective tissue than dark meat, it cooks **faster** and can become dry and stringy if care is not taken during the **cooking process**.

The older the poultry muscle, the **tougher** it will be. Consequently, cooking methods depend on the **age** of the bird when it was butchered.



**LESSON PLAN - POULTRY VOCABULARY -
TERM/DEFINITION MATCH**

From the kitchen of **MEAT & POULTRY COOKERY**

■ Purpose and Practice:

- Learner`s will review the description of 4 types of poultry.

■ Ingredients

Page 338
(learners' handout)

Pages 339
(4 sets of the 4
term/definition
match cards, color
coded)

■ Method

- Instructor prepares appropriate number of sets of the 4 terms and definitions by cutting them out along the dotted lines so that the term is separated from its definition.
- Shuffle each set so that they are not in order.
- Distribute a complete (shuffled) set to each group (2 to 5 students per group)
- Invite each group to work together (encouraging total participation) to match the correct term to the correct definition of the term.
- Come together as a whole class to review matches
- Provide each learner with a copy of the handout called "Poultry Vocabulary"

■ Cooking Time

15 minutes

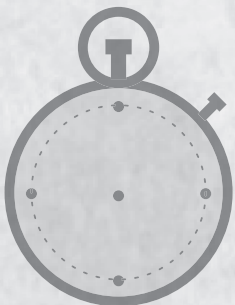

■ Essential Skills being practiced

- ✓ Thinking Skills
- ✓ Document Use
- ✓ Working with Others

Tip:

sets are color coded so that they do not get mixed up when collecting them after the exercise.

POULTRY VOCABULARY

Vegetables are divided into categories. These categories are organized according to which part of the plant is eaten and or used.

Term	Details
Frying Chickens	Very young chickens, usually six to eight weeks old. They are tender.
Roasting chickens	<p>These are young chickens that can be from 10 weeks to six months old. They are very tender and are different from older fowl by the following:</p> <ul style="list-style-type: none"> • Underdeveloped breastbone or flexible cartilage tip • Smooth white skin • Pale white fat at the cavity opening
Capons	These are neutered male birds which are butchered when they reach between five and eight months in age. They have excellent flavour, and are very tender.
Free Range Poultry Products	These are allowed freedom of movement, and they can forage on a natural diet that includes insects, seeds and foliage. These products are gaining increasing popularity within the industry and are prized for their exceptionally fine flavour and texture. Like organically grown vegetables, they usually sell at a premium price.

POULTRY VOCABULARY - TERMS & DETAILS MATCH

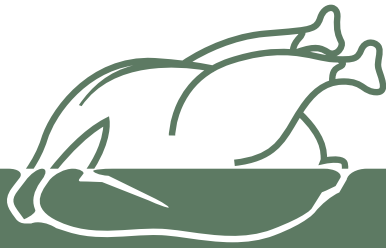

Frying Chickens

Very young chickens, usually six to eight weeks old. They are tender.

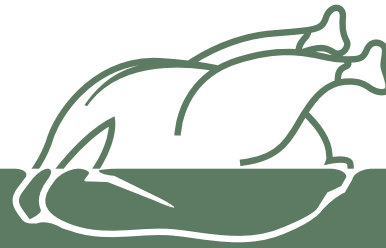

Roasting Chickens

These are young chickens that can be from 10 weeks to six months old. They are very tender and are different from older fowl by the following:

- Underdeveloped breastbone or flexible cartilage tip
- Smooth white skin
- Pale white fat at the cavity opening

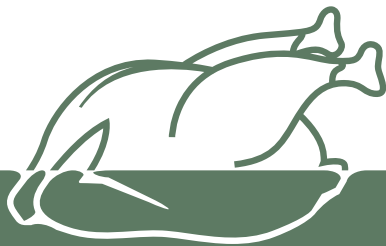

Capons

These are neutered male birds which are butchered when they reach between five and eight months in age. They have excellent flavour, and are very tender.

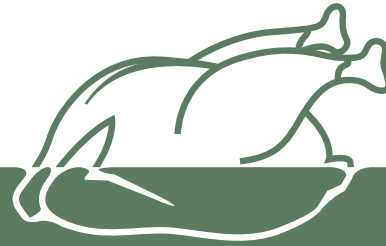

Free Range Poultry Products

These are allowed freedom of movement, and they can forage on a natural diet that includes insects, seeds and foliage. These products are gaining increasing popularity within the industry and are prized for their exceptionally fine flavour and texture. Like organically grown vegetables, they usually sell at a premium price.



**LESSON PLAN - ROASTING POULTRY -
FILL IN THE BLANKS**

From the kitchen of **MEAT & POULTRY COOKERY**

■ Purpose and Practice:

- Reading material previously studied in class and remembering what was learned.

■ Ingredients

Page 341
(learners' handout)

Page 342
(instructor's answer
key)

■ Method

- Instructor prepares appropriate number of "Roasting Poultry" handouts for the learners
- Individually, learners fill in the banks using the words provided to complete the passage.
- Instructor reviews the answers with the class in a group setting

■ Cooking Time

10 - 15 minutes



■ Essential Skills being practiced

- ✓ Reading Text
- ✓ Thinking Skills
- ✓ Writing
- ✓ Document Use

Tip:

The "fill in the blanks" exercises can be distributed to learners who finish group activities ahead of others. They may also be assigned as homework for those who did not get to work with them during class time.

ROASTING POULTRY - EXERCISE

There are 4 guidelines for roasting poultry. Fill in the blanks using the vocabulary below:

moist	juicy product	skin	lower
fat	cavity	before	brown
seasoned	basting		

1. The inside of the _____ can be _____.
2. The outside _____ should be seasoned and oiled _____ roasting begins as this helps to _____ the skin and to keep the bird _____.
3. _____ with _____ during the cooking process is essential for chickens and turkeys.
4. The oven should be preheated to 160 degrees Celsius (325 degrees Fahrenheit) or _____ if your production schedule will allow it. Low temperature roasting for chicken and turkey will result in a tender, _____.

ROASTING POULTRY - ANSWERS

There are 4 guidelines for roasting poultry. Fill in the blanks using the vocabulary below:

moist	juicy product	skin	lower
fat	cavity	before	brown
seasoned	basting		

1. The inside of the cavity can be seasoned.
2. The outside skin should be seasoned and oiled before roasting begins as this helps to brown the skin and to keep the bird moist.
3. basting with fat during the cooking process is essential for chickens and turkeys.
4. The oven should be preheated to 160 degrees Celsius (325 degrees Fahrenheit) or lower if your production schedule will allow it. Low temperature roasting for chicken and turkey will result in a tender, juicy product.



**LESSON PLAN - BROILING/GRILLING POULTRY -
FILL IN THE BLANKS**

From the kitchen of **MEAT & POULTRY COOKERY**

■ Purpose and Practice:

- Reading material previously studied in class and remembering what was learned.

■ Ingredients

Page 344
(learners' handout)

Page 345
(instructor's answer
key)

■ Method

- Instructor prepares appropriate number of "Broiling/Grilling Poultry" handouts for the learners
- Individually, learners fill in the banks using the words provided to complete the passage.
- Instructor reviews the answers with the class in a group setting

■ Cooking Time

10 - 15 minutes



■ Essential Skills being practiced

- ✓ Reading Text
- ✓ Thinking Skills
- ✓ Writing
- ✓ Document Use

Tip:

The "fill in the blanks" exercises can be distributed to learners who finish group activities ahead of others. They may also be assigned as homework for those who did not get to work with them during class time.

BROILING/GRILLING POULTRY - EXERCISE

Please complete the sentences below by inserting the most appropriate words.

flame**larger****oil****skin side down****young****lower****oven****preheated**

Only tender _____ birds can be cooked by this method. The broiler should be _____ and set at a slightly _____ temperature than for meat.

Start grilling poultry pieces _____, taking care to remove excess _____ which will cause the broiler to _____ and burn the chicken. It is sometimes wise to mark _____ pieces of poultry on the grill and then finish the cooking process in the _____.

BROILING/GRILLING POULTRY - ANSWERS

Please complete the sentences below by inserting the most appropriate words.

flame	larger	oil	skin side down
young	lower	oven	preheated

Only tender young birds can be cooked by this method. The broiler should be preheated and set at a slightly lower temperature than for meat.

Start grilling poultry pieces skin side down, taking care to remove excess oil which will cause the broiler to flame and burn the chicken. It is sometimes wise to mark larger pieces of poultry on the grill and then finish the cooking process in the oven.

LESSON PLAN - SAUTÉING POULTRY - 5 GUIDELINES FOR SAUTÉING POULTRY



From the kitchen of **MEAT & POULTRY COOKERY**

■ Purpose and Practice:

- Learner`s will review the 5 guidelines for sautéing poultry and then practice arranging the 5 steps in order.

■ Ingredients

Page 347
(learners' handout)

Pages 348
(4 sets of the seven steps strips, color coded)

■ Method

- Instructor prepares up to 4 sets by color code (depending on class size), of the Sautéing Poultry guidelines strips and shuffles each set so that they are not in order.
- Working in small groups, the learners arrange the Sautéing Poultry guidelines strips in order (Step 1: Remove roast from the pan, Step 2: ...)
- Instructor roams around and encourages the small groups
- Once the exercise is finished, invite the learners to walk around each set to see if they came up with the same order.

■ Cooking Time

15 - 20 minutes

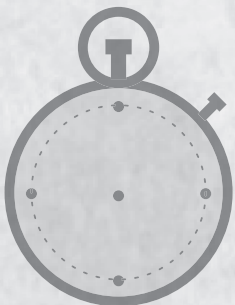

■ Essential Skills being practiced

- ✓ Reading Text
- ✓ Thinking Skills
- ✓ Document Use
- ✓ Working with Others

Tip:

Instructor may wish to review some of the vocabulary and invite learners to describe the meaning of terms such as ``dusting, sauté pan, deglazing, etc.``

Note: sets are color coded so that they do not get mixed up when collecting them after the exercise.

SAUTÉING POULTRY

As with broiling, only tender young birds can be cooked by this method. It is preferable to bone out the poultry as this will speed up the cooking time. If you use the following guidelines, you will be successful in sautéing poultry:

1. Assemble all equipment and food products.
2. Dust poultry to be sautéed with flour to prevent sticking in the pan and also to prevent moisture loss.
3. Heat a small amount of fat in the sauté pan until it is very hot. The food must be seared quickly or it will begin to simmer in its own juices.
4. The pan must not be overcrowded with food product as this will lower the temperature.
5. After the poultry has been sautéed, the pan is often deglazed with wine or stock and this liquid (with appropriate additions) will become an accompanying sauce.

SAUTÉING POULTRY - EXERCISE

Arrange the following guidelines in order:



Assemble all equipment and food products.



Dust poultry to be sautéed with flour to prevent sticking in the pan and also to prevent moisture loss.



Heat a small amount of fat in the sauté pan until it is very hot. The food must be seared quickly or it will begin to simmer in its own juices.



The pan must not be overcrowded with food product as this will lower the temperature.



After the poultry has been sautéed, the pan is often deglazed with wine or stock and this liquid (with appropriate additions) will become an accompanying sauce.



**LESSON PLAN - PAN FRYING POULTRY -
FILL IN THE BLANKS**

From the kitchen of **MEAT & POULTRY COOKERY**

■ Purpose and Practice:

- Reading material previously studied in class and remembering what was learned.

■ Ingredients

Page 350
(learners' handout)

Page 351
(instructor's answer
key)

■ Method

- Instructor prepares appropriate number of "Pan Frying Poultry" handouts for the learners
- Individually, learners fill in the banks using the words provided to complete the passage.
- Instructor reviews the answers with the class in a group setting

■ Cooking Time

10 - 15 minutes



■ Essential Skills being practiced

- ✓ Reading Text
- ✓ Thinking Skills
- ✓ Writing
- ✓ Document Use

Tip:

The "fill in the blanks" exercises can be distributed to learner's who finish group activities ahead of others. They may also be assigned as homework for those who did not get to work with them during class time.

PAN FRYING POULTRY - EXERCISE

Please complete the sentences below by inserting the most appropriate words.

browning**boned****fat****finished****breaded****cooked****sautéing****uncovered**

Pan-frying is cooking in a moderate amount of _____ over a moderate heat. It is

Similar to _____, the only difference being the amount of fat used.

Pan-frying is a popular form of cooking _____ chicken pieces that are

not _____ out. Care must be taken to ensure the chicken is properly

_____ without excessive surface _____. The pieces

may be _____ in the oven in an _____ pan.

PAN FRYING POULTRY - ANSWERS

Please complete the sentences below by inserting the most appropriate words.

browning**boned****fat****finished****breaded****cooked****sautéing****uncovered**

Pan-frying is cooking in a moderate amount of **fat** over a moderate heat. It is

Similar to **sautéing**, the only difference being the amount of fat used.

Pan-frying is a popular form of cooking **breaded** chicken pieces that are

not **boned** out. Care must be taken to ensure the chicken is properly

cooked without excessive surface **browning**. The pieces

may be **finished** in the oven in an **uncovered** pan.



**LESSON PLAN - DEEP FRYING POULTRY -
FILL IN THE BLANKS**

From the kitchen of **MEAT & POULTRY COOKERY**

■ Purpose and Practice:

- Reading material previously studied in class and remembering what was learned.

■ Ingredients

Page 353
(learners' handout)

Page 354
(instructor's answer
key)

■ Method

- Instructor prepares appropriate number of "Deep Frying Poultry" handouts for the learners
- Individually, learners fill in the banks using the words provided to complete the passage.
- Instructor reviews the answers with the class in a group setting

■ Cooking Time

10 - 15 minutes



■ Essential Skills being practiced

- ✓ Reading Text
- ✓ Thinking Skills
- ✓ Writing
- ✓ Document Use

Tip:

The "fill in the blanks" exercises can be distributed to learner's who finish group activities ahead of others. They may also be assigned as homework for those who did not get to work with them during class time.

DEEP FRYING POULTRY - EXERCISE

Correctly deep-fried poultry has a golden brown crust that is crisp and has absorbed very little fat. Poultry is dipped in bread crumbs or batter before frying.

There are 10 guidelines for roasting poultry. Fill in the blanks using the vocabulary below:

temperature	immediately	excess	cleaned
salt	overload	high	evenly
immersed	recipe	breeding	

1. Use good quality fat with a _____ smoke point.
2. Use good equipment that has been thoroughly _____.
3. Fry at the correct _____, 160^o to 175^o C (325^o to 350^oF).
4. Prepare the poultry to the specific _____.
5. Shake off excessive _____ material.
6. Do not _____ the basket.
7. Lower the poultry pieces into the fat; make sure they are completely _____ in the fat.
8. Allow to brown _____, and turn if necessary.
9. Lift out of the fat and allow the _____ fat to drain off.
10. Never _____ the food over the fat.
11. Drain the product well and serve _____.

DEEP FRYING POULTRY - ANSWERS

Correctly deep-fried poultry has a golden brown crust that is crisp and has absorbed very little fat. Poultry is dipped in bread crumbs or batter before frying.

There are 10 guidelines for roasting poultry. Fill in the blanks using the vocabulary below:

temperature	immediately	excess	cleaned
salt	overload	high	evenly
immersed	recipe	breeding	

1. Use good quality fat with a high smoke point.
2. Use good equipment that has been thoroughly cleaned.
3. Fry at the correct temperature, 160^o to 175^o C (325^o to 350^oF).
4. Prepare the poultry to the specific recipe.
5. Shake off excessive breeding material.
6. Do not overload the basket.
7. Lower the poultry pieces into the fat; make sure they are completely immersed in the fat.
8. Allow to brown evenly, and turn if necessary.
9. Lift out of the fat and allow the excess fat to drain off.
10. Never salt the food over the fat.
11. Drain the product well and serve immediately.



**LESSON PLAN - PRESSURE DEEP FAT FRYING -
FILL IN THE BLANKS**

From the kitchen of **MEAT & POULTRY COOKERY**

■ Purpose and Practice:

- Reading material previously studied in class and remembering what was learned.

■ Ingredients

Page 356
(learners' handout)

Page 357
(instructor's answer
key)

■ Method

- Instructor prepares appropriate number of "Pressure Deep Fat Frying" handouts for the learners
- Individually, learners fill in the banks using the words provided to complete the passage.
- Instructor reviews the answers with the class in a group setting

■ Cooking Time

10 - 15 minutes



■ Essential Skills being practiced

- ✓ Reading Text
- ✓ Thinking Skills
- ✓ Writing
- ✓ Document Use

Tip:

The "fill in the blanks" exercises can be distributed to learner's who finish group activities ahead of others. They may also be assigned as homework for those who did not get to work with them during class time.

PRESSURE DEEP FAT FRYING - EXERCISE

Please complete the sentences below by inserting the most appropriate words.

temperature	lower	steam	crispness
pressure cooker	quickly	covered	take out
covered			

A pressure deep fat fryer operates similarly to a _____.

The tight fitting _____ of a pressure fryer traps the _____ given off by the frying foods and builds up pressure in the fryer.

The trapped steam raises the _____ of the food in the fryer so that foods cook more _____ even though the fat temperatures may be _____ than found in a regular fryer. Pressure deep fat fryers are used in _____ deep-fried chicken operations.

Note: Breaded deep-fried products should not be _____ or placed on a steam table as this will cause their crust to lose _____.

PRESSURE DEEP FAT FRYING - ANSWERS

Please complete the sentences below by inserting the most appropriate words.

temperature	lower	steam	crispness
pressure cooker	quickly	covered	take out
covered			

A pressure deep fat fryer operates similarly to a pressure cooker.

The tight fitting cover of a pressure fryer traps the steam given off by the frying foods and builds up pressure in the fryer.

The trapped steam raises the temperature of the food in the fryer so that foods cook more quickly even though the fat temperatures may be lower than found in a regular fryer. Pressure deep fat fryers are used in take out deep-fried chicken operations.

Note: Breaded deep-fried products should not be covered or placed on a steam table as this will cause their crust to lose crispness.

LESSON PLAN - MOISTURE-HEAT COOKING METHODS FOR MEAT & POULTRY – FILL IN THE BLANKS



From the kitchen of **MEAT & POULTRY COOKERY**

■ Purpose and Practice:

- Reading material previously studied in class and remembering what was learned.

■ Ingredients

Page 359
(learners' handout)

Page 360
(instructor's answer key)

■ Method

- Instructor prepares appropriate number of "Moist-Heat Cooking Methods for Meat and Poultry" handouts for the learners
- Individually, learners fill in the banks using the words provided to complete the passage.
- Instructor reviews the answers with the class in a group setting

■ Cooking Time

10 minutes



■ Essential Skills being practiced

- ✓ Reading Text
- ✓ Thinking Skills
- ✓ Writing
- ✓ Document Use

Tip:

The "fill in the blanks" exercises can be distributed to learner's who finish group activities ahead of others. They may also be assigned as homework for those who did not get to work with them during class time.

MOIST-HEAT COOKING METHODS FOR MEAT AND POULTRY - EXERCISE

Please complete the sentences below by inserting the most appropriate words.

stock**water****heat****sauce**

Moist-heat cooking refers to methods where _____ is transferred to the food product by way of a liquid such as a _____, a _____, or the steam from a liquid. In some instances, such as blanching, _____ is used as the liquid.

MOIST-HEAT COOKING METHODS FOR MEAT AND POULTRY - ANSWERS

Please complete the sentences below by inserting the most appropriate words.

stock**water****heat****sauce**

Moist-heat cooking refers to methods where heat is transferred to the food product by way of a liquid such as a stock, a sauce, or the steam from a liquid. In some instances, such as blanching, water is used as the liquid.

**LESSON PLAN - MOIST-HEAT COOKING METHODS FOR MEAT
- TERM/DEFINITION MATCH**



From the kitchen of **MEAT & POULTRY COOKERY**

■ Purpose and Practice:

- Learner`s will review and study terms, methods and uses or examples of moist-heat cooking methods for meat and poultry.

■ Ingredients

Page 362 (study sheet for Meat)

Page 363 (exercise sheet for meat)

Page 364 (study sheet for poultry)

Page 365 (exercise sheet for poultry)

■ Method

- Instructor prepares appropriate number of study sheets for “Moist-Heat Cooking Methods for Meat” and “Moist-Heat Cooking Methods for Poultry”
- Learners review the study sheets.
- Instructor prepares and distributes the exercise sheets for “Moist-Heat Cooking Methods for Meat” and “Moist-Heat Cooking Methods for Poultry”
- Learners complete the exercise sheets on their own or in groups
- Come together as a whole class to review matches

■ Cooking Time

30 minutes



■ Essential Skills being practiced

- ✓ Reading Text
 - ✓ Thinking Skills
 - ✓ Document Use
 - ✓ Working with Others
- (if exercise is done in a group setting)

Tip:

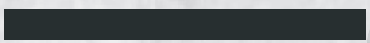

MOIST-HEAT COOKING METHODS FOR MEAT – TERMS/DEFINITIONS/EXAMPLES - STUDY SHEET**Moist-Heat Cooking for Meats**

Term	Method	Uses/Example
Simmering	The temperature of the liquid is only high enough to cause the slightest movement of bubbles bursting on the surface (not boiling).	For curing meats such as hams and corned beef.
Blanching	Meat is placed in cold water, the water is brought to a boil, the meat is then simmered for a short time and then refreshed with cold water.	Kidney Used to cleanse the meat of salt, blood, strong flavours and other impurities.

MOIST-HEAT COOKING METHODS FOR MEAT – TERMS/DEFINITIONS/EXAMPLES - EXERCISE

Identify the correct term to the methods described below. Provide an example and why the particular method is used for each example.

Moist-Heat Cooking for Meats

Term	Method	Uses/Example
	<p>The temperature of the liquid is only high enough to cause the slightest movement of bubbles bursting on the surface (not boiling).</p>	
	<p>Meat is placed in cold water, the water is brought to a boil, the meat is then simmered for a short time and then refreshed with cold water.</p>	

MOIST-HEAT COOKING METHODS FOR POULTRY – TERMS/DEFINITIONS/EXAMPLES - STUDY SHEET

Moist-Heat Cooking for Poultry

Term	Method	Uses/Example
Poaching	<p>A gentle and protective method of cooking a liquid such as stock with sometimes added herbs and wine.</p> <p>Only a small amount of liquid is used.</p>	<p>For the very tender and delicate flesh from the breasts of young poultry products. This method is used to retain flavour, texture and nutrients.</p>
Simmering	<p>The temperature of the liquid is only high enough to cause the slightest movement of bubbles bursting on the surface (not boiling).</p>	<p>For older, less tender poultry like “Boiling Fowl” or “Stewing Hens”</p> <p>These birds have normally have a fully developed breast-bone with no cartilage; rough, thick, bumpy skin; and excessive yellow fat at the cavity opening.</p>
Blanching	<p>Poultry is placed in cold water, the water is brought to a boil, then simmered for a short time and then refreshed with cold water.</p>	<p>Method is done before another cooking method to cut down on the cooking time.</p> <p>Chicken pieces which are to be grilled or cooked on a BBQ.</p>

MOIST-HEAT COOKING METHODS FOR POULTRY – TERMS/DEFINITIONS/EXAMPLES - EXERCISE

Identify the correct term to the methods described below. Provide an example and why the particular method is used for each example.

Moist-Heat Cooking for Poultry

Term	Method	Uses/Example
	<p>A gentle and protective method of cooking a liquid such as stock with sometimes added herbs and wine.</p> <p>Only a small amount of liquid is used.</p>	
	<p>The temperature of the liquid is only high enough to cause the slightest movement of bubbles bursting on the surface (not boiling).</p>	
	<p>Poultry is placed in cold water, the water is brought to a boil, then simmered for a short time and then refreshed with cold water.</p>	

**LESSON PLAN - COMBINATION HEAT COOKING METHODS -
FILL IN THE BLANKS**



From the kitchen of **MEAT & POULTRY COOKERY**

■ Purpose and Practice:

- Reading material previously studied in class and remembering what was learned.

■ Ingredients

Page 367
(learners' handout)

Page 368
(instructor's answer key)

■ Method

- Instructor prepares appropriate number of "Combination Heat Cooking Methods" handouts for the learners
- Individually, learners fill in the banks using the words provided to complete the passage.
- Instructor reviews the answers with the class in a group setting

■ Cooking Time

10 - 15 minutes

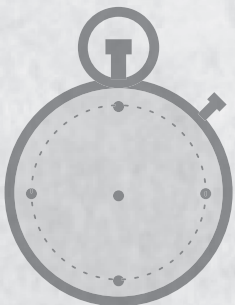

■ Essential Skills being practiced

- ✓ Reading Text
- ✓ Thinking Skills
- ✓ Writing
- ✓ Document Use

Tip:

The "fill in the blanks" exercises can be distributed to learner's who finish group activities ahead of others. They may also be assigned as homework for those who did not get to work with them during class time.

COMBINATION HEAT COOKING METHODS - EXERCISE

Please complete the sentences below by inserting the most appropriate words.

cooked	liquid	size	braising	braised
cuts	stewed	highest	combined	stewing
satisfying	pot roasting			

Combination cooking occurs when two or more methods of coming food are _____ in order to make less tender _____ more digestible and tasty. The most common products _____ by a combination of heat methods are those which are not of the _____ quality or most tender. The initial browning or searing of the food, the addition of _____ (such as stock), and the prolonged gentle cooking process, all contribute to making combination heat cooking one of the most _____ and creative cooking techniques.

The most common combination cooking methods are _____, _____, and _____. In meat cooking, the terms braising and stewing are used to distinguish the _____ of the meat being cooked. That is, individual portion sizes (for example, Swiss steaks) are braised while meats cut into cubes that are bite-sized (stewing beef) are _____.

COMBINATION HEAT COOKING METHODS - ANSWERS

Please complete the sentences below by inserting the most appropriate words.

cooked	liquid	size	braising	braised
cuts	stewed	highest	combined	stewing
satisfying	pot roasting			

Combination cooking occurs when two or more methods of coming food are combined in order to make less tender cuts more digestible and tasty. The most common products cooked by a combination of heat methods are those which are not of the highest quality or most tender. The initial browning or searing of the food, the addition of liquid (such as stock), and the prolonged gentle cooking process, all contribute to making combination heat cooking one of the most satisfying and creative cooking techniques.

The most common combination cooking methods are braising, stewing, and pot roasting. In meat cooking, the terms braising and stewing are used to distinguish the size of the meat being cooked. That is, individual portion sizes (for example, Swiss steaks) are braised while meats cut into cubes that are bite-sized (stewing beef) are stewed.

**LESSON PLAN - COMBINATION COOKING METHODS
MEAT & POULTRY – TERM/DEFINITION MATCH**



From the kitchen of **MEAT & POULTRY COOKERY**

■ Purpose and Practice:

- Learner`s will review and study methods and definitions for “Combination Cooking Methods for Meat and Poultry”

■ Ingredients

Page 370
(study sheet)

Page 371
(exercise sheet)

■ Method

- Instructor prepares appropriate number of study sheets for “Combination Cooking Methods for Meat and Poultry”
- Learners review the study sheet.
- Learners complete the exercise sheets on their own or in groups
- Learners complete the exercise sheets on their own or in groups
- Come together as a whole class to review matches

■ Cooking Time

30 minutes

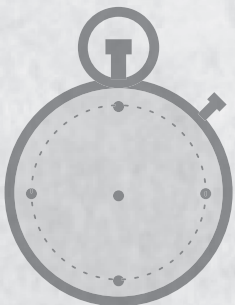

■ Essential Skills being practiced

- ✓ Reading Text
- ✓ Thinking Skills
- ✓ Document Use
- ✓ Working with Others
(if exercise is done in a group setting)

Tip:

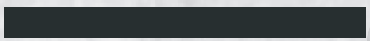

COMBINATION COOKING METHODS FOR MEAT AND POULTRY – TERMS/ DEFINITIONS - STUDY SHEET

Cooking Method	Definition
Braising	<p>Occurs when browned meat, vegetables and stock with seasonings are placed in a pot and simmered slowly.</p> <p>The product can be cooked in the oven or on the stove top.</p> <p>It is important to cook the product at an even heat as the liquid and the slow cooking break down the connective tissue in the meat to provide a tasty nutritious sauce and a very tender cooked product.</p>
Stewing	<p>Process of cooking food in a liquid that barely covers the items.</p> <p>The food is cut into bit size pieces so that several small pieces are needed to make up one individual portion.</p> <p>The meat is combined with neatly cut vegetables and simmered in a liquid with a bouquet garni.</p> <p>They may be thickened or unthickened depending on the recipe.</p> <p>Some are thickened with potatoes rather than a traditional roux (Irish).</p>
Pot Roasting	<p>The cut of meat is often browned in a pot (dry heat method) before being cooked by a heated liquid (moist heat method).</p> <p>Used to cook large pieces of less tender cuts of meat. The amount of liquid should not come higher than two-thirds of the way up the meat.</p>

COMBINATION COOKING METHODS FOR MEAT AND POULTRY – TERMS/ DEFINITIONS - EXERCISE

Cooking Method	Definition
	<p>Occurs when browned meat, vegetables and stock with seasonings are placed in a pot and simmered slowly.</p> <p>The product can be cooked in the oven or on the stove top.</p> <p>It is important to cook the product at an even heat as the liquid and the slow cooking break down the connective tissue in the meat to provide a tasty nutritious sauce and a very tender cooked product.</p>
	<p>Process of cooking food in a liquid that barely covers the items.</p> <p>The food is cut into bit size pieces so that several small pieces are needed to make up one individual portion.</p> <p>The meat is combined with neatly cut vegetables and simmered in a liquid with a bouquet garni.</p> <p>They may be thickened or unthickened depending on the recipe.</p> <p>Some are thickened with potatoes rather than a traditional roux (Irish).</p>
	<p>The cut of meat is often browned in a pot (dry heat method) before being cooked by a heated liquid (moist heat method).</p> <p>Used to cook large pieces of less tender cuts of meat. The amount of liquid should not come higher than two-thirds of the way up the meat.</p>



LESSON PLAN - COMBINATION COOKING REFERENCE CHART

From the kitchen of **MEAT & POULTRY COOKERY**

■ Purpose and Practice:

- This is a quick comparison reference chart between the techniques, products used, general procedure, and varieties of products for learners' review.

■ Ingredients

Page 373
(reference chart for study purposes)

■ Method

- Instructor prepares appropriate number of "Combination Heat Cooking Reference Charts"
- Instructor reviews the cooking techniques and encourages the learners to review.

■ Cooking Time

15-20 minutes
based on instructor's interest.

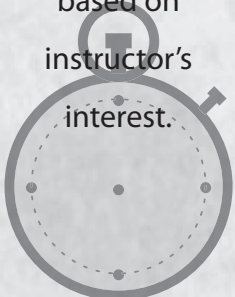

■ Essential Skills being practiced

- ✓ Document Use
- ✓ Working with Others
(if exercise is done in a group setting)

Tip:



COMBINATION HEAT COOKING REFERENCE CHART

Cooking Technique	Products Used	General Procedure	Varieties of Products
Braising (meats) Brown	Roasts or Portion cuts of less tender cuts	Sear product, prepare and add the cooking liquid, cover pot and simmer until tender	Swiss steaks, Braised short ribs, Osso bucco Braised roasts
Stewing (meats) Brown	Small boneless pieces of less tender cuts	Sear product, prepare and add the cooking liquid, cover pot and simmer until tender	Beef stew, Beef Bourguignon, Hungarian Goulash
Braising (poultry)	Portion cut chicken pieces	Brown product, prepare cooking liquid, cover and simmer until tender.	Coq au Vin Curry Chicken Chicken Cacciatore
Stewing (poultry)	Portion cut chicken pieces	2 methods (sauté or blanching)	
Fricassee (Saute method)	8 – cut chicken pieces or boneless pieces of veal	Saute product without browning, add vegetables, liquids or sauces, cover, simmer until tender.	Chicken fricassee, Veal fricassee
Blanquette (blanching method)	8 – cut chicken pieces or boneless pieces of veal, boneless lamb	Blanch product to remove impurities, simmer product in stock with vegetables until tender. Thicken, cover and simmer until flavours are developed.	Blanquette of veal Blanquette of chicken <i>Irish lamb stew*</i>

**Irish lamb stew is thickened with potatoes not roux*



**LESSON PLAN - PRIMAL CUTS OF BEEF –
FILL IN THE PARTS EXERCISE**

From the kitchen of **MEAT & POULTRY COOKERY**

■ Purpose and Practice:

- There are 9 primal cuts in a side of beef, five in the front quarter and four in the hindquarter. In this exercise, learners will review the nine primal cuts and then practice identifying them by the front and hind quarters

■ Ingredients

Page 375
(study chart)

Page 376
(exercise sheet –
fill in the parts by
quarter)

■ Method

- Instructor prepares appropriate number of “Primal Cuts of Beef – Chart”, and “Primal Cuts of Beef – Fill in the Parts Exercise”
- Instructor reviews the Chart with the learners
- Instructor invites the learner’s to study the chart and then from memory, practice filling in the parts by either front or hind quarter using the exercise sheet.

■ Cooking Time

15 minutes

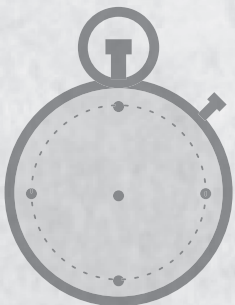

■ Essential Skills being practiced

- ✓ Thinking Skills
- ✓ Document Use

Tip:



PRIMAL CUTS OF BEEF - CHART

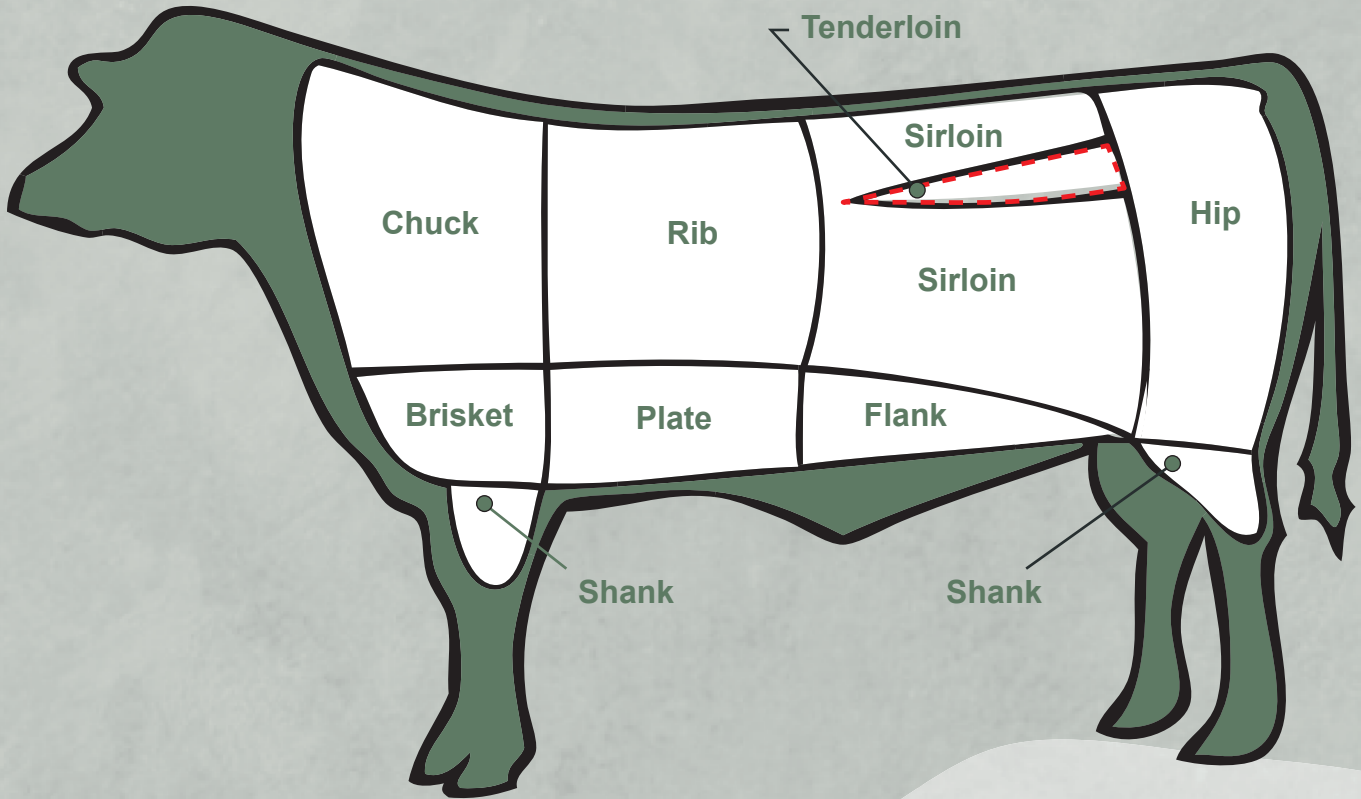

Front Quarter

- Chuck
- Shank
- Brisket
- Rib
- Plate

Hind Quarter

- Tenderloin
- Flank
- Sirloin
- Hip (Round)

PRIMAL CUTS OF BEEF - FILL IN THE PARTS EXERCISE

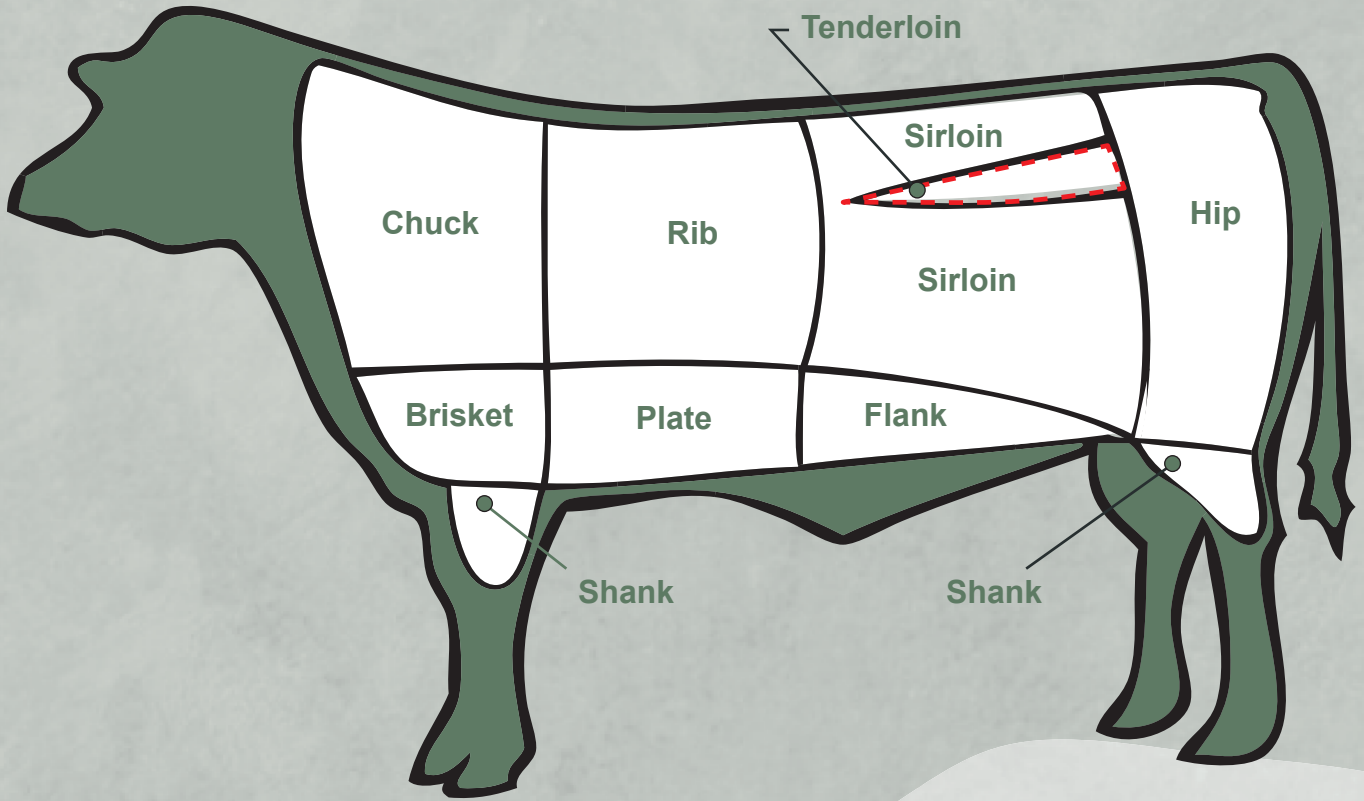

Front Quarter

Hind Quarter



LESSON PLAN - SECONDARY CUTS OF BEEF – FILL IN THE PARTS EXERCISE

From the kitchen of **MEAT & POULTRY COOKERY**

■ Purpose and Practice:

- Beef primal cuts are subdivided into secondary cuts. In this exercise, learners will review the secondary cuts and then practice identifying these secondary by primal cut category.

■ Ingredients

Page 378
(study chart)

Page 379
(exercise sheet –
identify the primary
cuts related to
the secondary cut
groupings)

■ Method

- Instructor prepares appropriate number of “Secondary Cuts of Beef – Chart”, and “Secondary Cuts of Beef – Fill in the Parts Exercise”
- Instructor reviews the Chart with the learners
- Instructor invites the learner’s to study the chart and then from memory, practice writing the primal cuts related to each secondary parts grouping.

■ Cooking Time

15 minutes

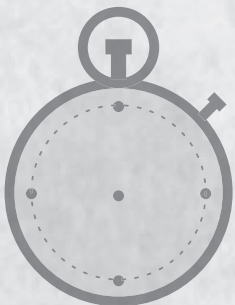

■ Essential Skills being practiced

- ✓ Thinking Skills
- ✓ Document Use

Tip:



SECONDARY CUTS OF BEEF - CHART

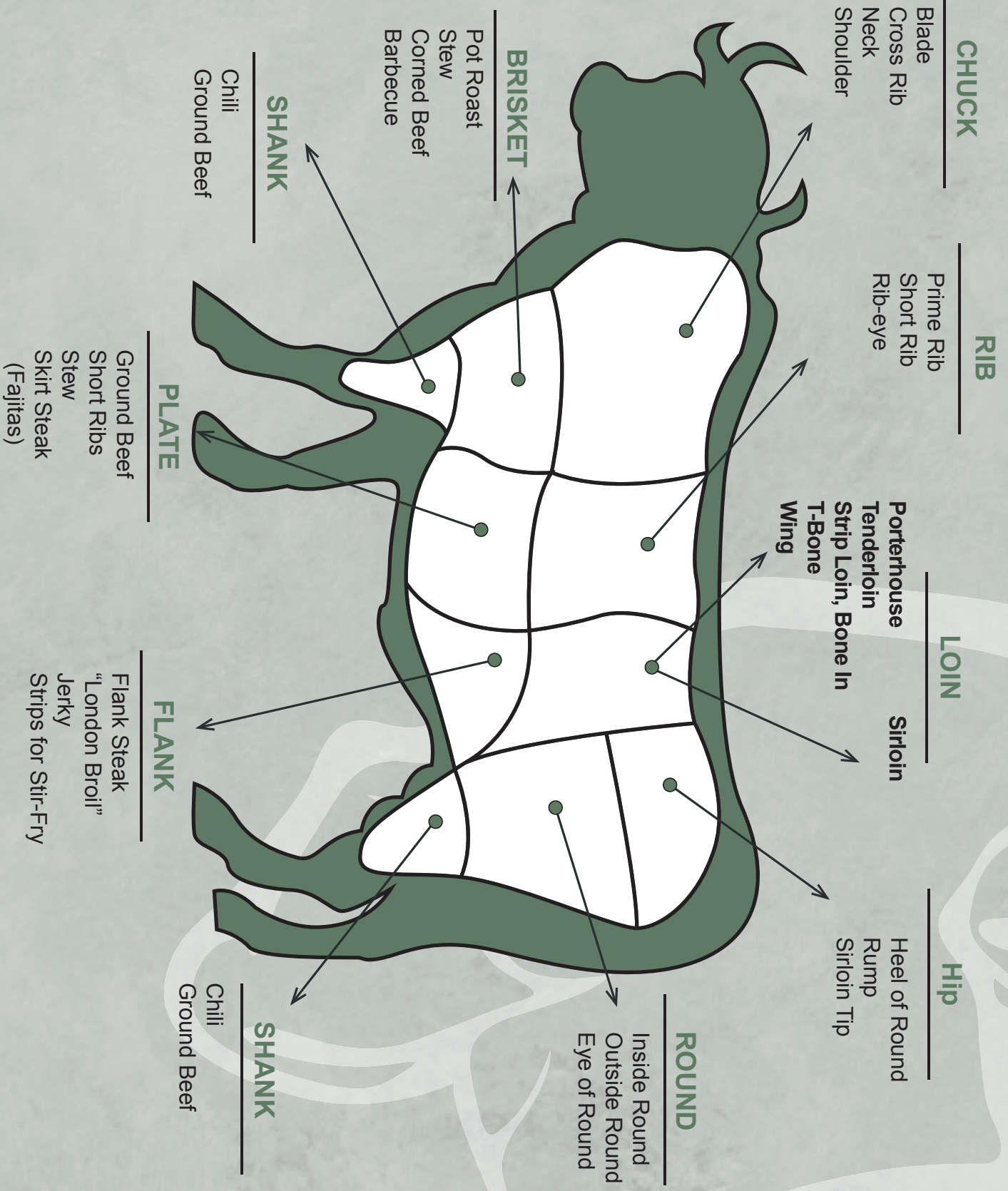

SECONDARY CUTS OF BEEF - FILL IN THE PARTS EXERCISE

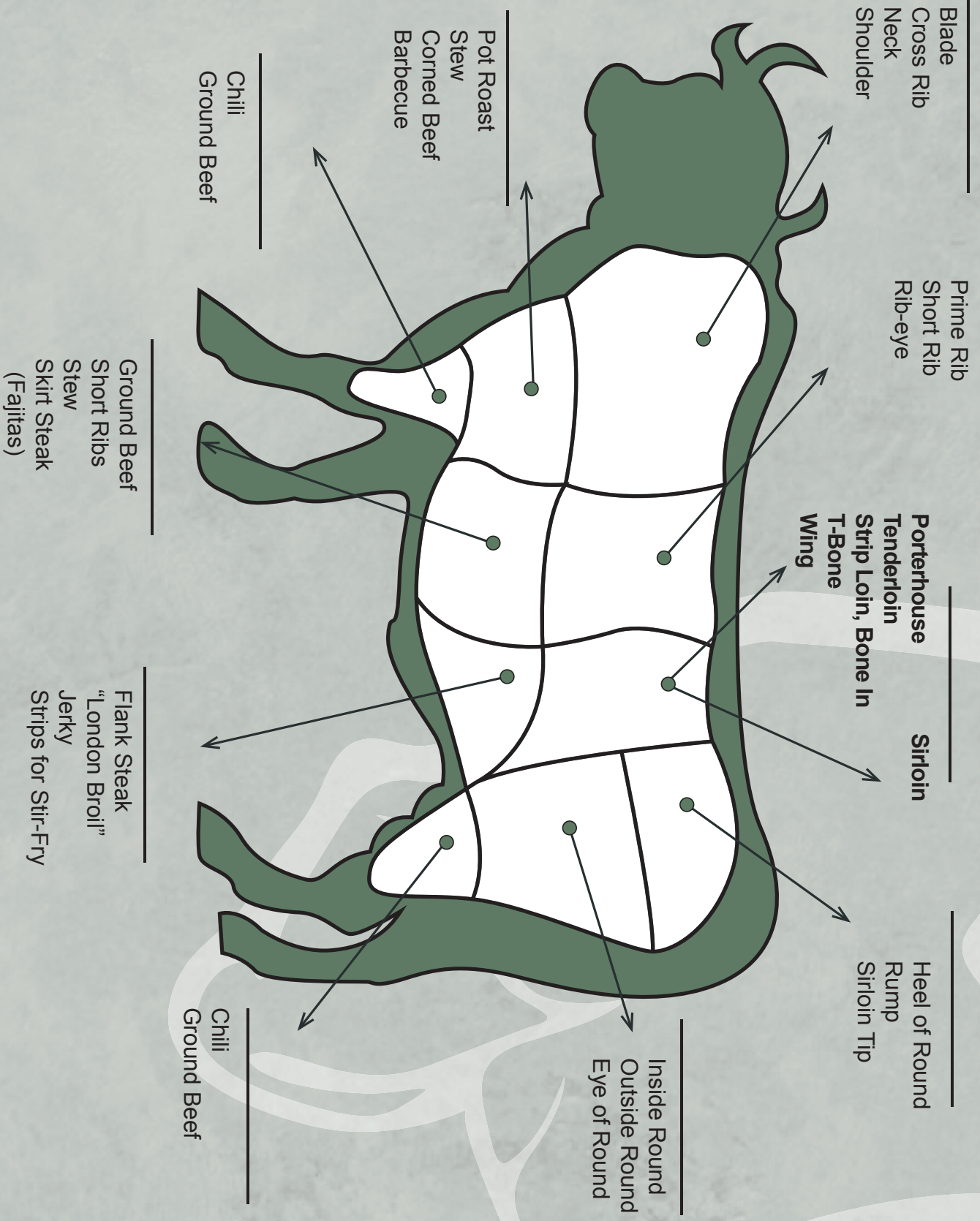



**LESSON PLAN - PRIMAL CUTS OF PORK –
FILL IN THE PARTS EXERCISE**

From the kitchen of **MEAT & POULTRY COOKERY**

■ Purpose and Practice:

- There are 4 primal cuts in a side of pork. In this exercise, learners will review the primal cuts and then practice identifying them by memorizing the parts and identifying them on the exercise sheet.

■ Ingredients

Page 381
(study sheet)

Page 382
(exercise sheet –
Name the Part)

■ Method

- Instructor prepares appropriate number of “Primal Cuts of Pork – Study Sheet”, and “Primal Cuts of Pork – Name the Part”
- Instructor reviews the Chart with the learners
- Instructor invites the learner’s to study the chart and then from memory, practice filling in the parts.

■ Cooking Time

15 minutes

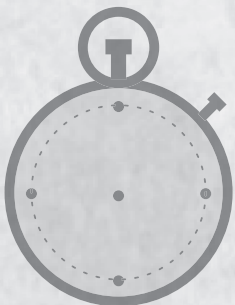

■ Essential Skills being practiced

- ✓ Thinking Skills
- ✓ Document Use

Tip:



PRIMAL CUTS OF A SIDE OF PORK - STUDY SHEET

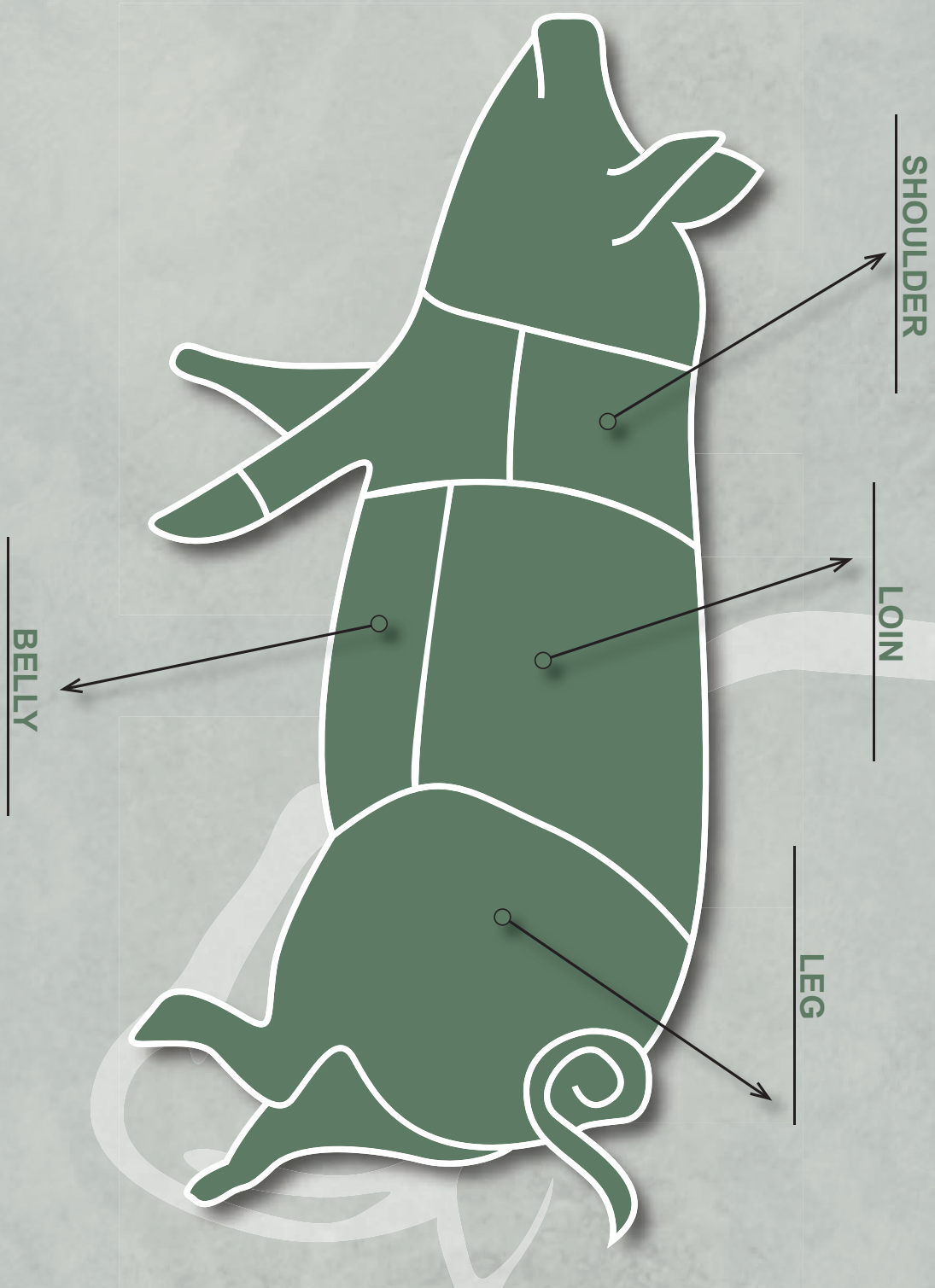

PRIMAL CUTS OF A SIDE OF PORK - NAME THE PART

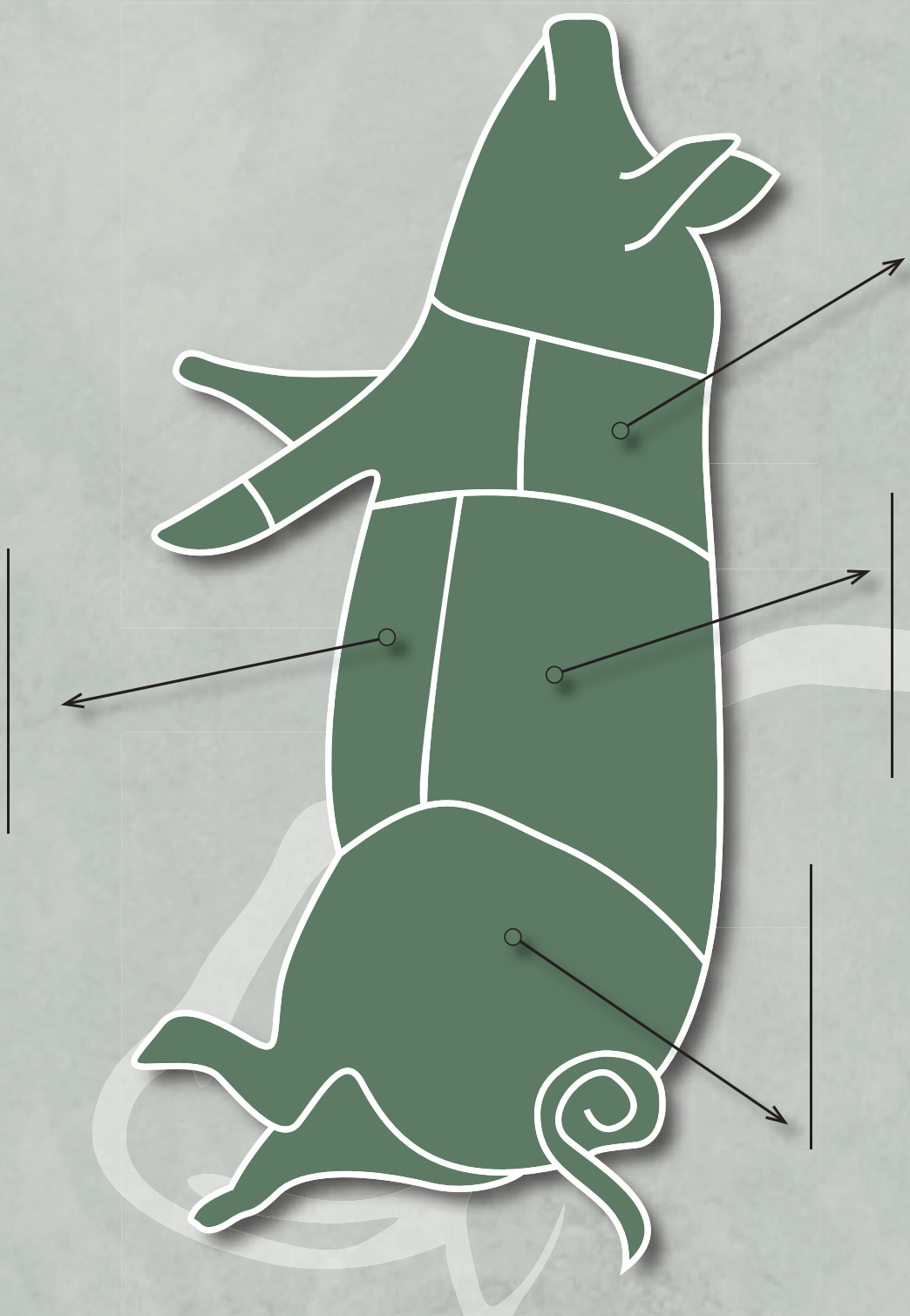



**LESSON PLAN - SECONDARY CUTS OF PORK –
NAME THE SECONDARY CUTS**

From the kitchen of **MEAT & POULTRY COOKERY**

■ Purpose and Practice:

- Pork primal cuts are subdivided into secondary cuts. In this exercise, learners will review the secondary cuts and then practice identifying them by primal cut category.

■ Ingredients

Page 384
(study sheet)

Page 385
(exercise sheet –
Name the Second-
ary Cuts)

■ Method

- Instructor prepares appropriate number of “Secondary Cuts of Pork – Study Sheet”, and “Secondary Cuts of Pork – Name the Secondary Cuts”
- Instructor reviews the Chart with the learners
- Instructor invites the learner’s to study the chart and then from memory, practice identifying the secondary cuts by primal cut category.

■ Cooking Time

15 - 20 minutes

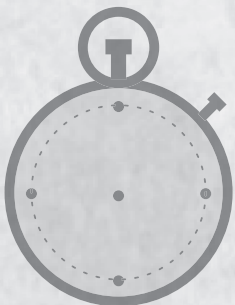

■ Essential Skills being practiced

- ✓ Thinking Skills
- ✓ Document Use

Tip:



SECONDARY CUTS OF PORK - STUDY SHEET

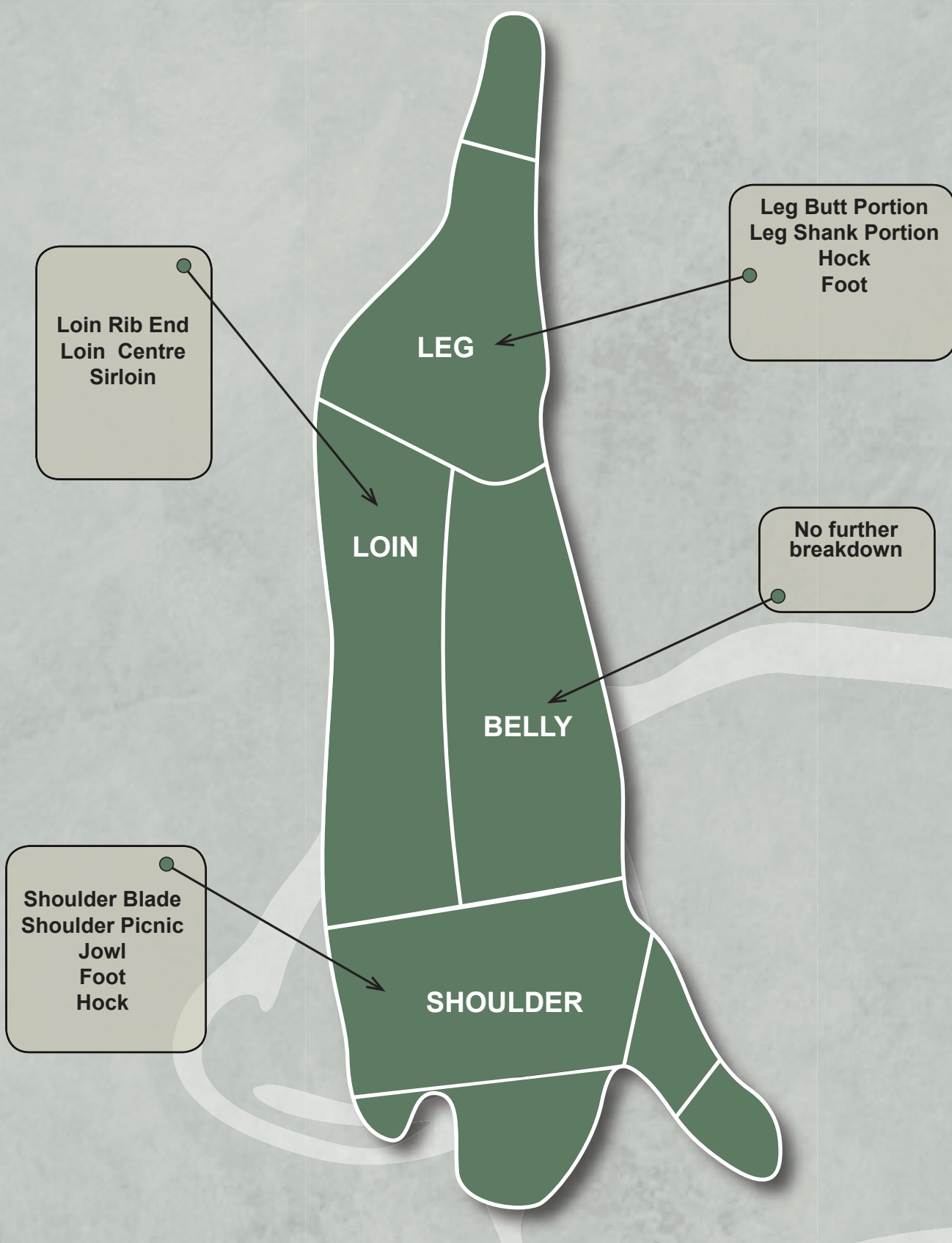

SECONDARY CUTS OF PORK - NAME THE SECONDARY CUTS

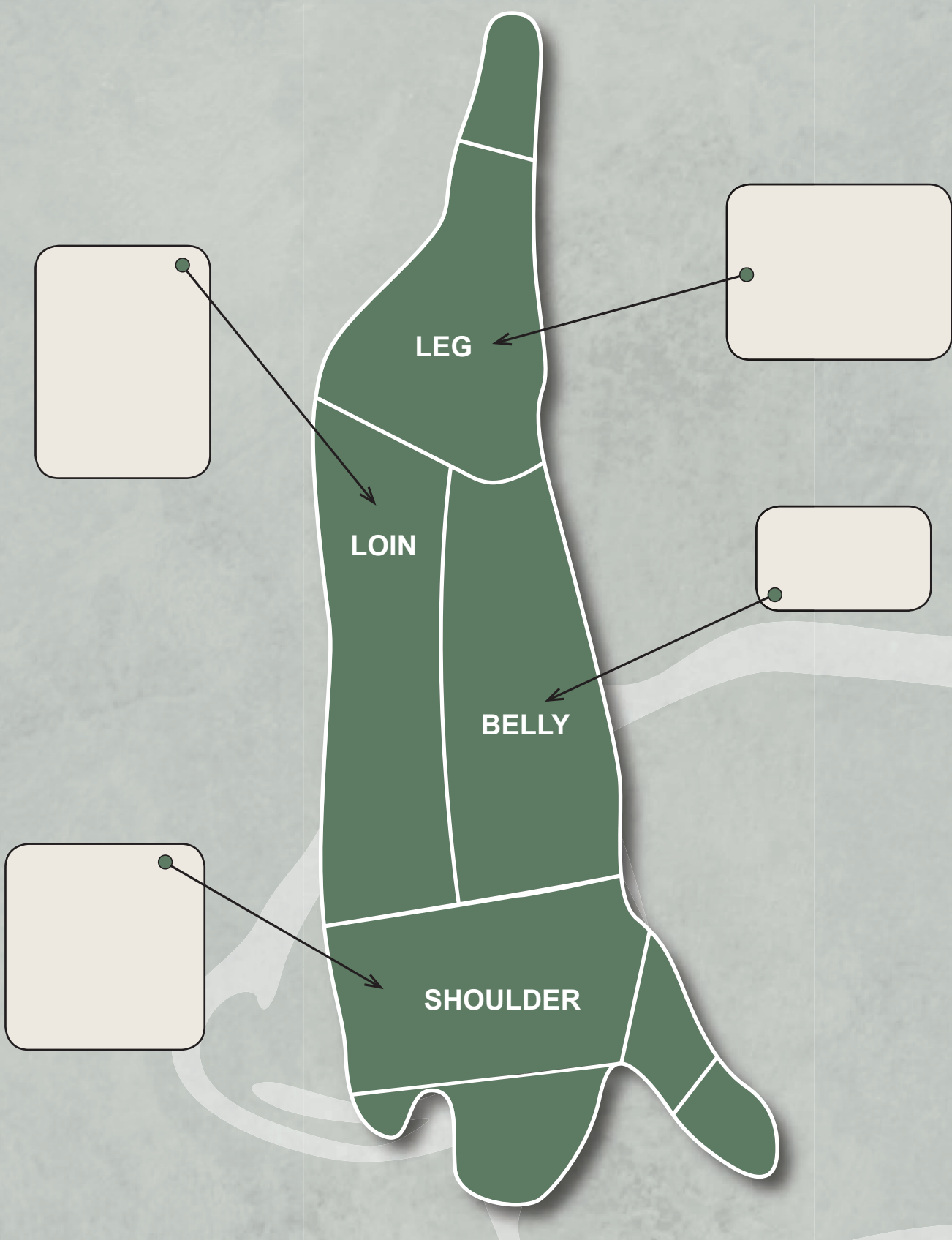

SECONDARY CUTS OF PORK - NAME THE PRIMAL CUTS





LESSON PLAN - MEAT CUTS WORD SEARCH

From the kitchen of **MEAT & POULTRY COOKERY**

■ Purpose and Practice:

- To become more familiar with the sections of meat vocabulary

■ Ingredients

Page 389
Word Search
Exercise

Page 390
Word Search
Answer Key

■ Method

- Instructor makes appropriate number of the Word Search handouts for the class
- Instructor hands out `Word Search Exercise` to each learner.
- Using the words at the bottom of the sheet, Learners are encouraged to locate the identical word that is hidden within the puzzle above
- Once a word is located within the puzzle, learner cross off that word from the vocabulary list and moves on to the next word
- Words can be found horizontally, vertically and diagonally
- Post the answer key somewhere in the classroom so that learners may self-check their work

■ Cooking Time

learners can work on the puzzle throughout the day when they have extra time

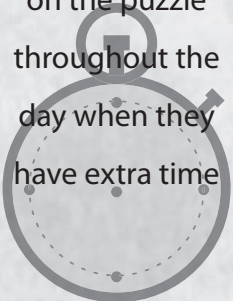

■ Essential Skills being practiced

- ✓ Thinking Skills
- ✓ Document Use

Tip:

this is a good opportunity to check comprehension around the meaning of "horizontally, vertically and diagonally"

MEAT CUTS WORD SEARCH

Find the words below in this word search puzzle.

i i c h u c k i a t
 k i m l o i n l i s
 s a k e q q a b r h
 u h b s u o h r h n
 r p o i a e s i q l
 k t k r r t e s n r
 n h n l t a r k t d
 a f h o e l o e e h
 l a m i r p t t u b
 f h e n p f f e e b

-
- | | | |
|--------|---------|---------|
| beef | brisket | butt |
| primal | flank | shank |
| chuck | hind | hip |
| front | plate | quarter |
| loin | short | sirloin |
| rib | | |

MEAT CUTS WORD SEARCH - ANSWERS

Find the words below in this word search puzzle.

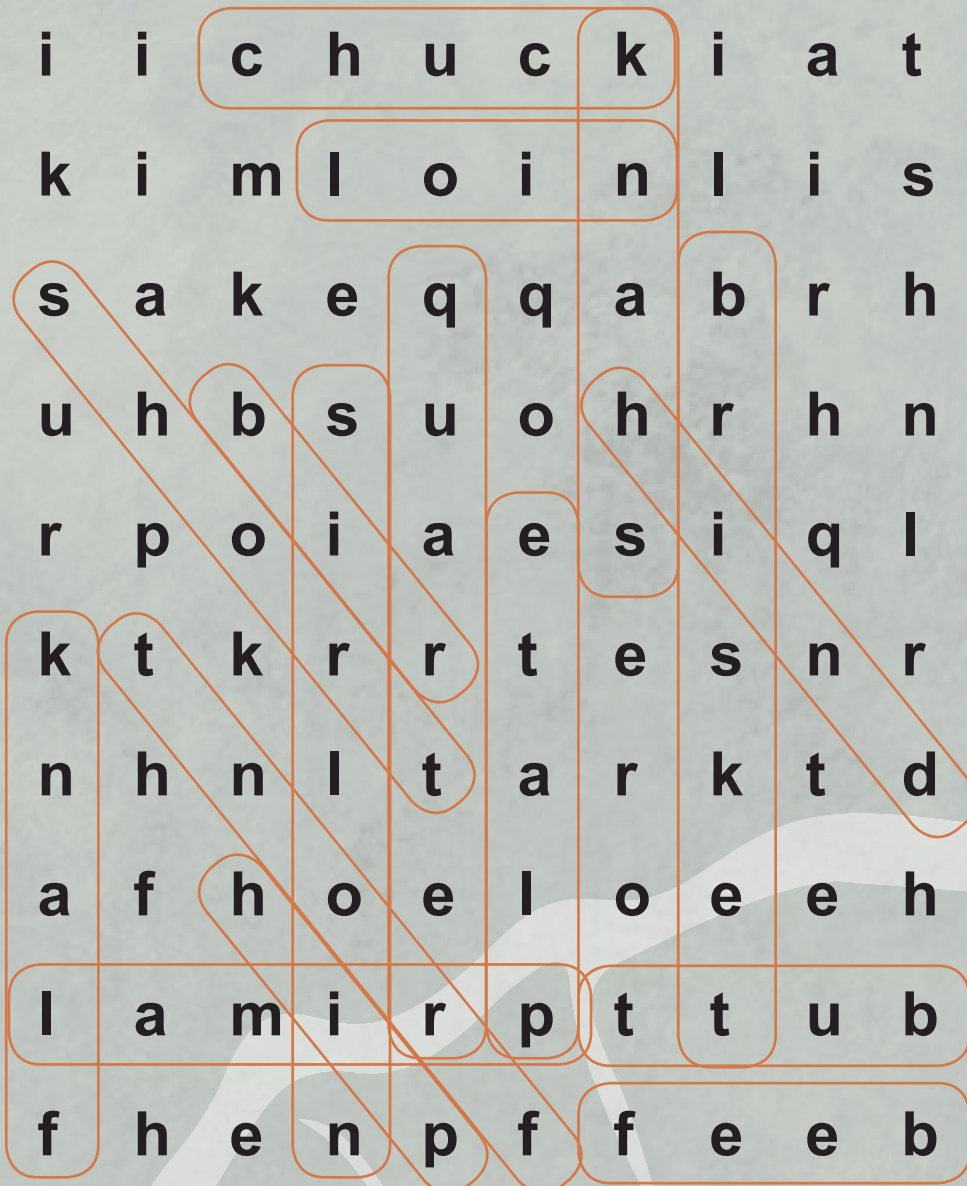

beef

brisket

butt

primal

flank

shank

chuck

hind

hip

front

plate

quarter

loin

short

sirloin

rib



BASIC FOOD SERVICE & KITCHEN MANAGEMENT



LESSON PLAN - BASIC COOKING PRINCIPLES - EXERCISE

BASIC FOOD SERVICES & KITCHEN MANAGEMENT

From the kitchen of _____

■ Purpose and Practice:

- To review basic cooking terminology by completing a fill-in-the-blanks exercise

■ Ingredients

Page 393
Basic Cooking
Principles Exercise

Page 394
Basic Cooking
Principles Exercise
Answer Key

■ Method

- Instructor prepares appropriate number of sets of exercise sheets
- Individually, learners fill in the blanks using the words provided at the top of the sheet
- Review answers together as a group using the answer key as a reference

■ Cooking Time

20 minutes

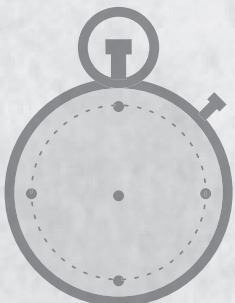

■ Essential Skills being practiced

- ✓ Document Use
- ✓ Thinking Skills

Tip: _____

Learners may be encouraged to strike off a term once used so that they can see which terms have been used along the way.

BASIC COOKING PRINCIPLES - EXERCISE

Use the following words to fill in the blanks in the sentences below on basic cooking principles:

tenderness	evaporate	sterilized	carbonized
changes	food products	chew	flavour
melt	caramelized	tenderize	raw
cellulose	killed		

Cooking can be defined as subjecting _____ to heat to make them more digestible than they are in their _____ state. Heat breaks down the _____ (fibre) of plant food and partly dissolved the connective tissues in meat which increases _____. When enough heat is applied, the food is _____ as the bacteria in or on it are _____.

The heat causes water to _____, starched to become fluffy and fats to _____, break down and brown. When sugar is heated, it melts and becomes _____ (color changes to brown). When heated even more, the sugar is _____ (burned).

These physical and chemical _____ not only _____ food so it is easy to _____ and digest but also changes the _____ and appearance.

BASIC COOKING PRINCIPLES - ANSWERS

Use the following words to fill in the blanks in the sentences below on basic cooking principles:

tenderness	evaporate	sterilized	carbonized
changes	food products	chew	flavour
melt	caramelized	tenderize	raw
cellulose	killed		

Cooking can be defined as subjecting food products to heat to make them more digestible than they are in their raw state. Heat breaks down the cellulose (fibre) of plant food and partly dissolved the connective tissues in meat which increases tenderness. When enough heat is applied, the food is sterilized as the bacteria in or on it are killed.

The heat causes water to evaporate, starched to become fluffy and fats to melt, break down and brown. When sugar is heated, it melts and becomes caramelized (color changes to brown). When heated even more, the sugar is carbonized (burned). These physical and chemical changes not only tenderize food so it is easy to chew and digest but also changes the flavour and appearance.



**LESSON PLAN - BASIC METHODS OF COOKING -
STUDY SHEET - EXERCISE**

**BASIC FOOD SERVICES &
KITCHEN MANAGEMENT**

From the kitchen of _____

■ Purpose and Practice:

- To review examples of 3 basic methods of cooking

■ Ingredients

Page 396
Basic Methods of
Cooking Study Sheet

Page 397
Basic Methods of
Cooking – Exercise 1

Page 398
Basic Methods of
Cooking – Exercise 2

■ Method

- In small groups, learners study examples of the 3 basic types of cooking methods
- Learners practice committing the information to memory
- Learners test their knowledge by completing Exercise 1
- Learners further test their knowledge by completing Exercise 2

■ Cooking Time

30 minutes

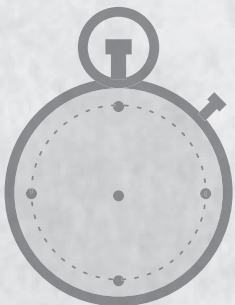

■ Essential Skills being practiced

- ✓ Thinking Skills - Significant use of memory
- ✓ Document Use

Tip:

Learners may be encouraged to discuss tips and tricks for memorizing information.

BASIC METHODS OF COOKING - STUDY SHEET

Method of Cooking	Examples
<p>Dry Heat</p>	<p>Roasting Baking Broiling Pan-frying Sautéing Grilling Deep fat frying</p>
<p>Moist Heat</p>	<p>Poaching Steaming Blanching Boiling Simmering</p>
<p>Combination Heat</p>	<p>Braising Stewing</p>

BASIC METHODS OF COOKING - EXERCISE 1

Identify the method of cooking across from the list of examples below:

Method of Cooking	Examples
	Roasting Baking Broiling Pan-frying Sautéing Grilling Deep fat frying
	Poaching Steaming Blanching Boiling Simmering
	Braising Stewing

BASIC METHODS OF COOKING - STUDY SHEET

Identify examples across from the method of cooking below:

Method of Cooking	Examples
<p style="text-align: center;">Dry Heat</p>	<ol style="list-style-type: none"> 1. 2. 3. 4. 5. 6. 7.
<p style="text-align: center;">Moist Heat</p>	<ol style="list-style-type: none"> 1. 2. 3. 4. 5.
<p style="text-align: center;">Combination Heat</p>	<ol style="list-style-type: none"> 1. 2.



LESSON PLAN - BASIC SEASONING & FLAVOURING TECHNIQUES

BASIC FOOD SERVICES & KITCHEN MANAGEMENT

From the kitchen of _____

■ Purpose and Practice:

- Matching Seasoning and Flavouring related vocabulary to definitions
- Learning the difference between herbs and spices, and seasoning and flavoring

■ Ingredients

Page 400 Basic Seasoning & Flavouring Techniques Study Sheet

Pages 401, 402
(7 vocabulary/definition cut outs – to make sets for group work)

Page 403 Basic Seasoning and Flavouring Techniques Exercise Sheet

■ Method

- Instructor provides each student with a study sheet for their review
- Instructor prepares appropriate number of sets of the 7 terms by photocopying the 7 "Spice racks" and cutting them out along the dotted lines so that the top of the spice rack (vocabulary word) is separated from the bottom of the spice rack (definition).
- Shuffle word and definitions so that they are not in order
- Distribute a complete (shuffled) set to each group (2 to 5 students per group)
- Invite each group to work together (encouraging total participation) to match the correct term e correct with the correct definition of the term
- Once matched, invite the groups to identify examples of herbs, spices, seasonings and flavourings
- Learners complete the Exercise sheet to strengthen the learning

■ Cooking Time

30 minutes

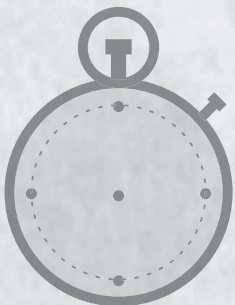

■ Essential Skills being practiced

- ✓ Thinking Skills
- ✓ Working With Others
- ✓ Oral Communication
- ✓ Document Use
- ✓ Reading Text

Tip:

To avoid mixing up sets for future use, tag each one for easy re-set and shuffle. For example, each piece of set #1 has a blue dot on each piece, set #2 a red dot, etc.

BASIC SEASONING AND FLAVOURING TECHNIQUES – STUDY SHEET

Terms	Description
Seasoning	This technique brings out or intensifies the natural flavour of the food without changing it
Seasonings	Usually added near the end of the cooking period. Most common ones are: salt, pepper and lemon juice. When used properly they cannot be tasted. Only the original ingredients have been heightened.
Flavouring	This technique changes or modifies the original flavour of the food.
Flavourings	Used to contrast a taste, for example adding sherry to a consommé so that you can taste both the added flavour (sherry) and the original flavour (consommé). Also used to create a unique flavour by combining (for example: mirepoix added to a stock).
Herbs and Spices	Main seasoning and flavouring ingredients
Herbs	The leaves of fragrant plants that do not have a woody stem. Available fresh or dried.
Spices	Aromatic plant buds, fruits, flowers, roots or seeds. Available whole or ground up.

BASIC SEASONING AND FLAVOURING TECHNIQUES – WORDMATCH



This technique brings out or intensifies the natural flavour of the food without changing it



Usually added near the end of the cooking period. Most common ones are: salt, pepper and lemon juice. When used properly they cannot be tasted. Only the original ingredients have been heightened.



This technique changes or modifies the original flavour of the food.



Used to contrast a taste, for example adding sherry to a consommé so that you can taste both the added flavour (sherry) and the original flavour (consommé). Also used to create a unique flavour by combining (for example: mirepoix added to a stock).

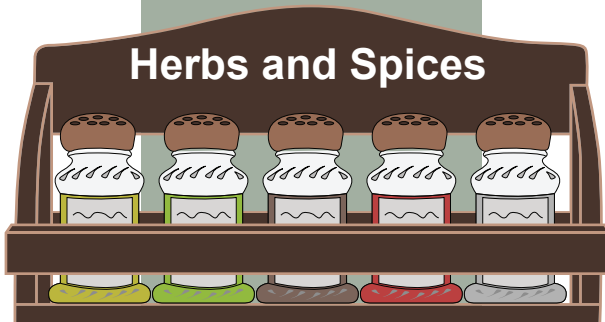

Herbs and Spices

Main seasoning and flavouring ingredients

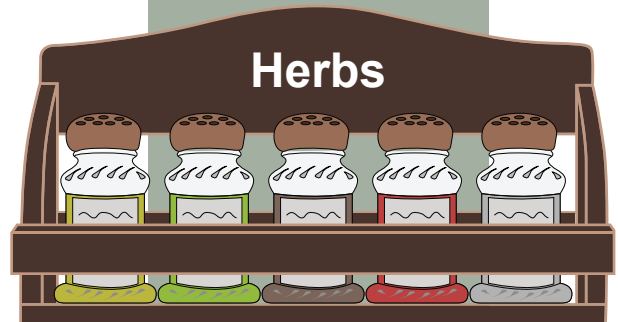

Herbs

The leaves of fragrant plants that do not have a woody stem. Available fresh or dried.

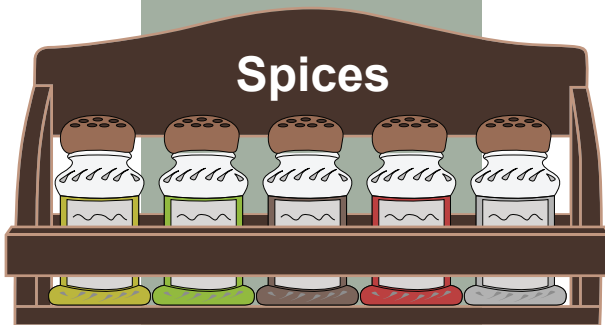

Spices

Aromatic plant buds, fruits, flowers, roots or seeds. Available whole or ground up.

BASIC SEASONING AND FLAVOURING TECHNIQUES – EXERCISE

Please insert the correct term:

Terms	Description
	This technique brings out or intensifies the natural flavour of the food without changing it
	Usually added near the end of the cooking period. Most common ones are: salt, pepper and lemon juice. When used properly they cannot be tasted. Only the original ingredients have been heightened.
	This technique changes or modifies the original flavour of the food.
	Used to contrast a taste, for example adding sherry to a consommé so that you can taste both the added flavour (sherry) and the original flavour (consommé). Also used to create a unique flavour by combining (for example: mirepoix added to a stock).
	Main seasoning and flavouring ingredients
	The leaves of fragrant plants that do not have a woody stem. Available fresh or dried.
	Aromatic plant buds, fruits, flowers, roots or seeds. Available whole or ground up.



LESSON PLAN - AM I A SPICE OR AN HERB?

BASIC FOOD SERVICES & KITCHEN MANAGEMENT

From the kitchen of _____

■ Purpose and Practice:

- To identify commonly used herbs and spices in today's kitchens
- Learning the difference between herbs and spices

■ Ingredients

Page 405
Study Sheet (table format)

Page 406
Exercise Sheet

Page 407
Answer Key

■ Method

- Instructor provides each student with a study sheet for their review and discusses the difference between a spice and an herb (see previous exercise)
- Instructor prepares appropriate number of exercise sheets; learners practice deciding if the ingredient is a spice or an herb
- Instructor reviews answers using the answer key

■ Cooking Time

20 minutes

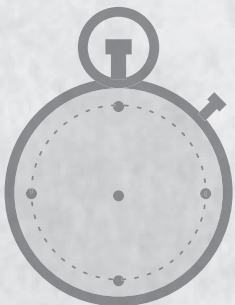

■ Essential Skills being practiced

- ✓ Document Use
- ✓ Thinking Skills

Tip:

The instructor may wish to create a sampler of the actual spices and herbs so that learners may see what the items look like and smell like.

BASIC SEASONING AND FLAVOURING TECHNIQUES – EXERCISE

Commonly used herbs and spices in today's kitchens:

Spices	Herbs
Allspice	Bay leaves
Anise seed	Chive
Cloves	Mint
Ginger	Sage
Nutmeg	Basil
Pepper	Parsley
Caraway	Rosemary
Cinnamon	Tarragon
Mace	Thyme
Mustard	

AM I A SPICE OR HERB - EXERCISE

Identify the items below as either a spice or an herb:

Item	Am I a Spice or Herb?
Mustard	
Tarragon	
Pepper	
Bay leaves	
Sage	
Allspice	
Nutmeg	
Parsley	
Cinnamon	
Basil	
Cloves	
Chive	
Anise seed	
Mint	
Ginger	
Caraway	
Rosemary	
Thyme	
Mace	

AM I A SPICE OR HERB - ANSWERS

Identify the items below as either a spice or an herb:

Item	Am I a Spice or Herb?
Mustard	Spice
Tarragon	Herb
Pepper	Spice
Bay leaves	Herb
Sage	Herb
Allspice	Spice
Nutmeg	Spice
Parsley	Herb
Cinnamon	Spice
Basil	Herb
Cloves	Spice
Chive	Herb
Anise seed	Spice
Mint	Herb
Ginger	Spice
Caraway	Spice
Rosemary	Herb
Thyme	Herb
Mace	Spice



LESSON PLAN - RECEIVING METHODS - EXERCISE

BASIC FOOD SERVICES & KITCHEN MANAGEMENT

From the kitchen of _____

■ Purpose and Practice:

- Reading material previously studied in class
- Remembering what was learned

■ Ingredients

Page 409
learners' handout

Page 410
instructor's answer
key

■ Method

- Instructor prepares appropriate number of "Receiving Methods" handouts for the learners
- Individually, learners fill in the banks using the words provided to complete the passage.
- Instructor reviews the answers with the class in a group setting

■ Cooking Time

20 minutes

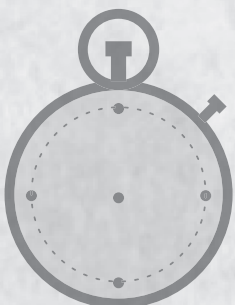

■ Essential Skills being practiced

- ✓ Document Use
- ✓ Reading Text
- ✓ Thinking Skills

Tip:

Encourage learners to strike off a word once it is used for easy tracking.

RECEIVING METHODS - EXERCISE

Use the following words to complete the sentences below on receiving methods:

receiving**errors****document****invoice****ordered****receives****checked**

The main reason for having a consistent method for accepting _____ goods is to ensure that the establishment _____ exactly what has been ordered. _____ often happen, and unless the quantity and quality of the items delivered are carefully _____ against what was ordered, big losses can happen. When _____ procedures are carefully performed, mistakes that could cost the restaurant time and money are avoided.

The most important _____ in determining if the goods received are the goods ordered is the _____.

RECEIVING METHODS - ANSWERS

Use the following words to complete the sentences below on receiving methods:

receiving**errors****document****invoice****ordered****receives****checked**

The main reason for having a consistent method for accepting ordered goods is to ensure that the establishment receives exactly what has been ordered. errors often happen, and unless the quantity and quality of the items delivered are carefully checked against what was ordered, big losses can happen. When receiving procedures are carefully performed, mistakes that could cost the restaurant time and money are avoided.

The most important document in determining if the goods received are the goods ordered is the invoice.



LESSON PLAN - INVOICES - EXERCISE

BASIC FOOD SERVICES & KITCHEN MANAGEMENT

From the kitchen of _____

■ Purpose and Practice:

- Reading material previously studied in class
- Remembering what was learned

■ Ingredients

Page 412
learners' handout

Page 413
instructor's answer
key

■ Method

- Instructor prepares appropriate number of "Invoices" handouts for the learners
- Individually, learners fill in the banks using the words provided to complete the passage.
- Instructor reviews the answers with the class in a group setting

■ Cooking Time

20 minutes

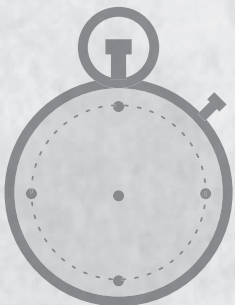

■ Essential Skills being practiced

- ✓ Document Use
- ✓ Reading Text
- ✓ Thinking Skills

Tip:

Encourage learners to strike off a word once it is used for easy tracking.

INVOICES - EXERCISE

Use the following words to complete the sentences below on invoice methods:

inspecting	purchase order	itemized	opening
accepted	price	matches	discrepancies
signature	belong	recorded	responsibilities

An invoice is an _____ list of the goods delivered to an establishment.

An invoice shows the quantity, quality, and _____ per kilogram or unit. Only by careful comparison and checking can you be sure that the information on the invoice _____ with the products received.

Whenever possible, the invoice also should be checked against the _____. The quality of the goods should be determined before the goods are _____. For example, _____ boxes of fresh produce and _____ frozen foods should be done to ensure quality.

When you are satisfied that the delivery is in order, write your _____ on the invoice. Once you have signed, you have relieved the delivery company of its _____ and the supplies now _____ to your company. After you sign off, you may become responsible for any _____ between what is on the invoice and what has been delivered to you.

Do not sign the invoice until you are sure that all discrepancies have been taken care of and _____ on the invoice.

INVOICES - ANSWERS

Use the following words to complete the sentences below on invoice methods:

inspecting	purchase order	itemized	opening
accepted	price	matches	discrepancies
signature	belong	recorded	responsibilities

An invoice is an itemized list of the goods delivered to an establishment.

An invoice shows the quantity, quality, and price per kilogram or unit. Only by careful comparison and checking can you be sure that the information on the invoice matches with the products received.

Whenever possible, the invoice also should be checked against the purchase order. The quality of the goods should be determined before the goods are accepted. For example, opening boxes of fresh produce and inspecting frozen foods should be done to ensure quality.

When you are satisfied that the delivery is in order, write your signature on the invoice. Once you have signed, you have relieved the delivery company of its responsibilities and the supplies now belong to your company. After you sign off, you may become responsible for any discrepancies between what is on the invoice and what has been delivered to you.

Do not sign the invoice until you are sure that all discrepancies have been taken care of and recorded on the invoice.



LESSON PLAN - RECEIVING PRACTICES – PHRASE MATCH

BASIC FOOD SERVICES & KITCHEN MANAGEMENT

From the kitchen of _____

■ Purpose and Practice:

- Reading material previously studied in class
- Practice matching sentence parts (phrases) to form the best possible sentence

■ Ingredients

Page 415
Learner's study
sheet "Receiving
Practices"

Page 416
Phrase Match
Activity Sheet

■ Method

- Instructor prepares appropriate number of Receiving Practices Study Sheet for the learner's review
- Instructor and learners review the receiving practices together and discuss
- Instructors makes 2-5 sets of the Receiving practices Phrase match page by cutting the phrases into strips and shuffling them so that the phrases are not in order
- In small groups, learners match phrases together to form a meaningful sentence
- Learners refer to their study sheet to check their work

■ Cooking Time

30 minutes

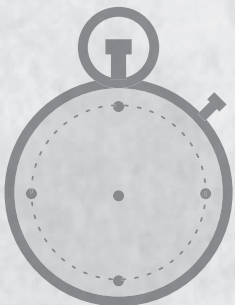

■ Essential Skills being practiced

- ✓ Oral Communication
- ✓ Document Use
- ✓ Working with Others
- ✓ Thinking Skills

Tip:

If learners are struggling, invite them to look for the phrases that begin with a capital letter and those phrases ending with a period.

RECEIVING PRACTICES – STUDY SHEET

The Hazard Analysis and Critical Control Points (HACCP) system is an operation system which ensures that as many precautions as possible are undertaken to eliminate, minimize or prevent any kind of unacceptable contamination.

The following are important elements to consider when receiving products in general:

- ✓ Never assume that all the food you receive is good enough to eat
- ✓ The receiving dock and related areas should be well lit and kept very tidy. Make sure this is area is part of your daily cleaning routine.
- ✓ Schedule your deliveries to allow enough time for proper inspection and receiving of all food products
- ✓ Have all the necessary equipment and containers on hand like scales, plastic gloves, containers and thermometers.
- ✓ Record the temperatures of the delivery truck's refrigerated and freezer storage. If the temperature is not within an adequate range do not accept the shipment.

RECEIVING PRACTICES – PHRASE MATCH

Match the following sentence parts (phrases) to form the best possible sentence.

Never assume that all the food you receive

is good enough to eat

The receiving dock and related areas should be well lit

and kept very tidy. Make sure this area is part of your daily cleaning routine.

Schedule your deliveries to allow enough time

for proper inspection and receiving of all food products

Have all the necessary equipment and containers on hand

like scales, plastic gloves, containers and thermometers.

Record the temperatures of the delivery truck's refrigerated and freezer storage. If the temperature is not within an adequate range

do not accept the shipment.

LESSON PLAN - SUGGESTED RECEIVING METHODS – QUESTIONNAIRE



BASIC FOOD SERVICES & KITCHEN MANAGEMENT

From the kitchen of _____

■ Purpose and Practice:

- Reading material previously studied in class
- Reviewing qualities of dry foods, dairy products, produce and meats, poultry and seafood

■ Ingredients

Page 418
Learner's study sheet "Suggested Receiving Methods"

Page 419
Suggested Receiving Methods questionnaire

Page 420
Suggested Receiving Methods answer key

■ Method

- Instructor prepares appropriate number of the Suggested Receiving Methods study sheet and the questionnaire
- Learners review the information individually and the information is discussed as a whole group
- Learner's complete the questionnaire on their own
- Instructor reviews the answers with the group

■ Cooking Time

30 minutes

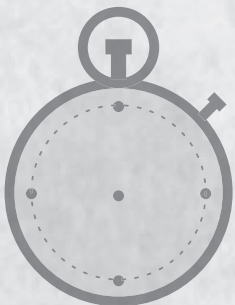

■ Essential Skills being practiced

- ✓ Reading Text
- ✓ Writing
- ✓ Thinking Skills

Tip: _____

SUGGESTED RECEIVING METHODS – READING EXERCISE

Each group of food products requires a different receiving procedure. The procedure depends on whether the products are dry foods, dairy products, fresh produce or meats. No matter what the product type, the principal component in a receiving procedure is accuracy.

■ Dry Foods:

Dry foods or goods are usually shipped in cartons, bags, cases or pails. Count the pieces and check that the number of pieces match with the number listed on the invoice. It is a good practice to tick on the invoice the items that are correct.

If a carton is damaged, check inside the carton carefully to be sure that the goods are not damaged. Pay special attention to leaky cartons that contain products in glass jars or bottles because it is difficult to get credit once the delivery person has left your premises.

If sealed cartons look like they have been opened, check the contents. Check bags and pails for damage or leakage.

Canned goods are delivered in cases or cartons. A count and a quality check of the cans should be made. The two most common types of damage to cans are swelling and large dents.

■ Dairy Products

Dairy products are perishable and do not store long. Check the date on each container; it shows a “Best Before Date”. The “Best Before Date” should be about a week away from the receiving date.

■ Produce

Produce is delivered in bags, cases or cartons. Count the number of pieces, weigh items and check for quality. Open closed cases and cartons to check the produce for ripeness, freshness and other signs of quality.

■ Meats, poultry and seafood

Fresh meat is shipped in pieces and/or by weight. Count and weigh the fresh meat items. Check for leaking vacuum packed (Cryovac) packages and check the grade of the meat against the grade on the invoice. Confirm that the cuts of meat are the way that was ordered.

Frozen products are often delivered in cases and cartons. Open the cases and cartons to count the items and to check for signs of freezer burn, torn wrappings, partial thawing or other kinds of problems.

SUGGESTED RECEIVING METHODS – QUESTIONNAIRE

1. What are the two most common types of damage to cans?

2. What should the “Best Before Date” be?

3. Name two things that you must check produce for

4. Name three things that you must check frozen foods for

5. What is another term for vacuum packed packages?

6. What should you do if a box or carton is damaged upon delivery?

SUGGESTED RECEIVING METHODS – ANSWERS

1. What are the two most common types of damage to cans?

swelling and large dents

2. What should the “Best Before Date” be?

a week away from the receiving date

3. Name two things that you must check produce for

ripeness and freshness

4. Name three things that you must check frozen foods for

freezer burn, torn wrappings, partial thawing

5. What is another term for vacuum packed packages?

Cryovac

6. What should you do if a box or carton is damaged upon delivery?

open the box/carton to make sure that the contents aren't damaged



**LESSON PLAN - STORING METHODS –
STUDY SHEET - A/B/C**

**BASIC FOOD SERVICES &
KITCHEN MANAGEMENT**

From the kitchen of _____

■ Purpose and Practice:

- Reading material previously studied in class
- Identifying storage methods for dry goods, refrigerated products, dairy products, produce, fresh meats, poultry and seafood, and frozen foods.
- Drawing the ideal dry goods storage room

■ Ingredients

Pages 422, 423, 424
Storing Methods
Study Sheet A, B
and C

Page 425, 426
Storing Methods
Exercise 1

Page 427, 428
Storing Methods
Exercise 2
(Blank paper and
markers)

■ Method

- Instructor prepares appropriate number of Study Sheets A, B and C
- In small group, learners review the information and discuss
- Continuing in small groups, the learners draw an ideal dry goods storage room using the information provided in study sheet A
- Each group presents their ideal storage room
- Instructor provides appropriate number of Exercise 2, questionnaire
- In the same small groups, learners complete the questionnaire together
- All come together to review the answers to Exercise 2

■ Cooking Time

1 hour

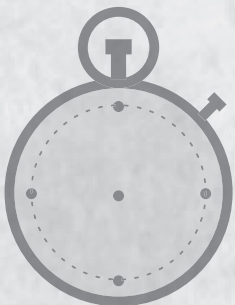

■ Essential Skills being practiced

- ✓ Working with Others
- ✓ Reading Text
- ✓ Document Use
- ✓ Oral Communication
- ✓ Thinking Skills

Tip: _____

This exercise could be turned into a poster exercise by providing larger size posterette paper and lots of colorful markers and other craft supplies.

STORING METHODS – STUDY SHEET - A

Storage	Details
Dry Food	<p>Storeroom:</p> <p>Area should be dry and cool</p> <p>Ideal temperature 10 – 15 degrees C (50 to 59 degrees F)</p> <p>Room should be easy to clean. All wall, ceiling and floor openings should be sealed and protected to prevent access by rodents and bugs.</p> <p>Supplies should be easy to arrange and rearrange in the space for easy stock rotation; shelves should be in the middle of the room so they can be stocked by both sides.</p> <p>FIFO means “first in, first out” concept for stock rotation.</p> <p>Area should be well lit.</p> <p>Do not store items right on the floor; shelving must be at least 15 cm above the floor.</p> <p>Aisles should be wide enough to allow entry for carts or dollies to prevent injuries from lifting.</p> <p>Storage room should be locked to prevent from people stealing supplies. Consider it like a bank safe.</p>
Refrigerated Products	<p>Basic rule: Store raw products below, NEVER above your cooked or “ready to eat” products.</p> <p>All refrigerators should be provided with a thermometer and daily readings taken.</p> <p>They must be kept in perfect working order and a regular service contract should be made with a local refrigerator repair company.</p> <p>If the refrigerator stops running, always check the power supply cord or breaker.</p> <p>Clean refrigerators on a regular basis.</p> <p>Use the FIFO system.</p> <p>Never put hot foods in the refrigerator.</p> <p>Do not leave the refrigerator door open for longer than necessary.</p>

STORING METHODS – STUDY SHEET - B

Storage	Details
Dairy Products	<p>Must be stored at 2 to 4^o C (36 to 39^o F).</p> <p>Should be stored in their own storage area in protective coverings because the fat in dairy products picks up strong odors from other foods.</p> <p>Do not store dairy products in a vegetable cooler.</p> <p>Rotate dairy products when new stock arrives; these products should not be ordered too far in advance.</p>
Produce	<p>Most produce is stored at 2 to 4^o C (36 to 39^o F) to ensure freshness and to prevent spoilage. Potatoes and bananas should be stored at higher temperatures (bananas will turn black quickly if stored in a refrigerator).</p> <p>Soft fruits should not be stored too long; its best to buy soft fruits as you need them.</p> <p>Unripe fruit can be ripened at storeroom temperatures. They will ripen much more slowly under refrigerator conditions.</p> <p>Removing rotting fruit from cases as one piece can affect other pieces; the chain reaction can quickly destroy the quality of a whole case of fruit!</p> <p>Hardy vegetables like carrots and cabbage last for weeks.</p> <p>Delicate vegetables like lettuce should be bought as fresh as possible as they do not keep well.</p> <p>Moisture on vegetables makes them soft and cause rot.</p>

STORING METHODS – STUDY SHEET - C

Storage	Details
<p>Fresh meats, poultry and seafood</p>	<p>Fresh meat should not be kept too long.</p> <p>Don't keep boned meat longer than three days. Use individual cuts within two days. Its best to use them on the day they were cut!</p> <p>Keep individual meat cuts like steaks, chops, stewing meat and ground beef covered on plastic or stainless steel trays at 2 to 4 degrees C (36 to 39^o F).</p> <p>Fresh poultry should be packed in ice and stored in the refrigerator.</p> <p>Fresh seafood should be packed in ice, and stored at -1 to 1 degree C (30 to 34^o F) and used as soon as possible.</p>
<p>Frozen Foods</p>	<p>Frozen fruit and vegetables will keep for months if they are properly wrapped.</p> <p>Fish and meat can also keep frozen for a long time if properly wrapped.</p> <p>Improperly wrapped frozen foods will develop “freezer burn” which is a loss of moisture that affects both the texture and the flavour of the food. A common sign of freezer burn is a white or grey dry spot on the surface of the frozen product. Meat is especially prone to freezer burn.</p> <p>Stock rotation is extremely important, so use the FIFO system.</p>

STORING METHODS – EXERCISE 1

Using the information from your Storing Methods Study Sheet, draw and label the ideal dry goods storeroom below:

STORING METHODS – EXERCISE 1 - SAMPLE

Using the information from your Storing Methods Study Sheet, draw and label the ideal dry goods storeroom below:

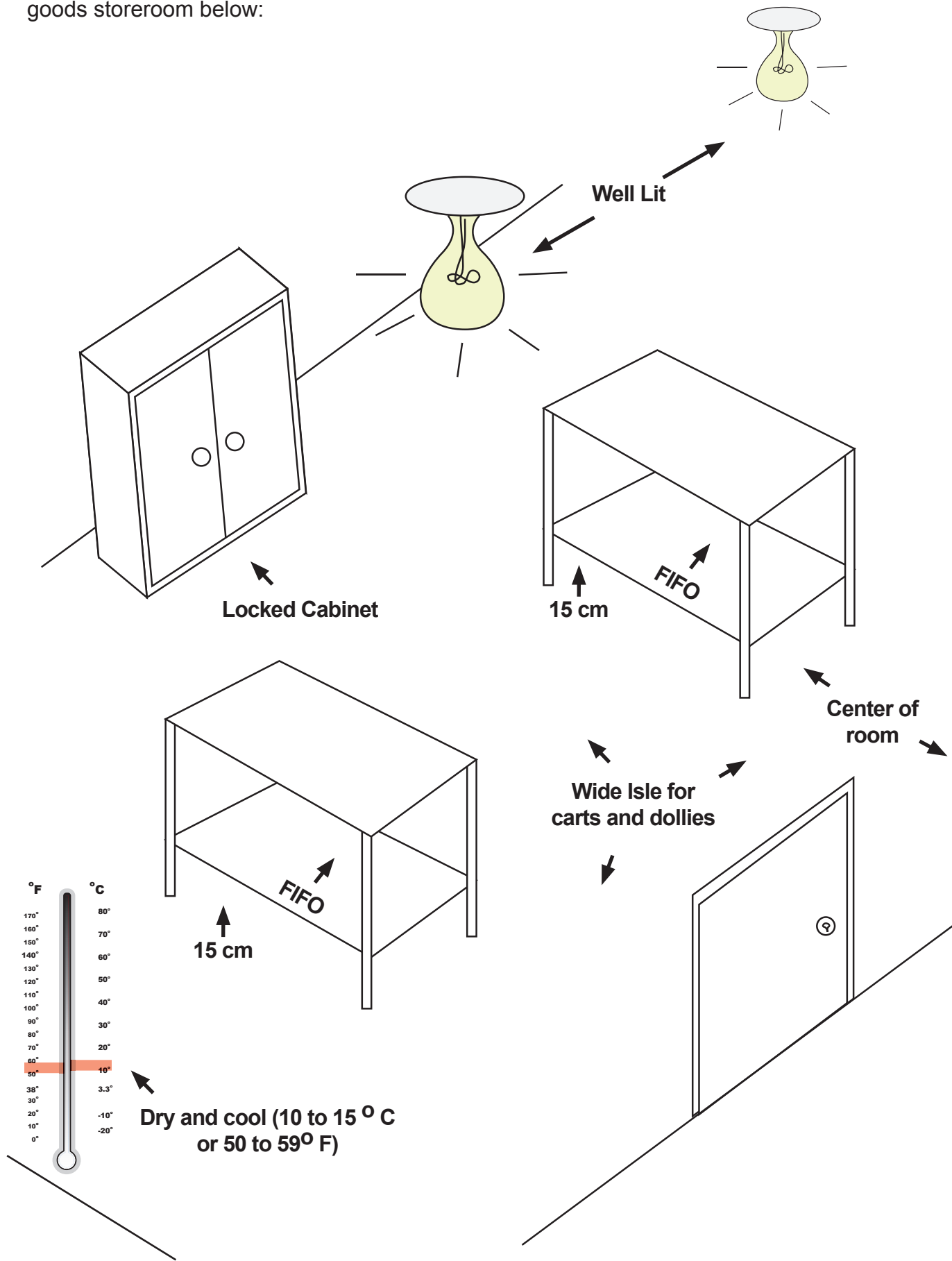

STORING METHODS – EXERCISE 2



1. What does FIFO stand for and what does it mean?

2. What is the basic rule for storing refrigerated products?

3. Why should dairy products be stored away from other foods?

4. Why should rotting fruit be removed from cases right away?

5. Describe “freezer burn”. What does it look like?

STORING METHODS – EXERCISE 2 ANSWERS



1. What does FIFO stand for and what does it mean?

First in, first out: means the first item stored should be the first item used (example use eggs bought on Monday before the ones bought on Friday)

2. What is the basic rule for storing refrigerated products?

Store raw products below, and never above cooked or “ready to eat” products.

3. Why should dairy products be stored away from other foods?

Because the fat in dairy products picks up strong odors from other foods.

4. Why should rotting fruit be removed from cases right away?

Because one rotten piece can affect another and could ruin the whole case.

5. Describe “freezer burn”. What does it look like?

Freezer burn is a loss of moisture that affects texture and flavour. Looks like a white or grey spot of the frozen product



LESSON PLAN - FOOD DETERIORATION

BASIC FOOD SERVICES & KITCHEN MANAGEMENT

From the kitchen of _____

■ Purpose and Practice:

- To name 3 agents (mould, yeast and bacteria) and their corresponding characteristics

■ Ingredients

Page 430
Food Deterioration
Study Sheet

Page 431
Food Deterioration
Exercise 1

Page 432
Food Deterioration
Answer key

■ Method

- Instructor makes appropriate number of Food Deterioration study sheets
- Individually, learners review the three agents and their corresponding characteristics
- Instructor hands out the exercise sheet and learners practice committing the information to memory by completing the exercise
- Whole class reviews the answers

■ Cooking Time

20 minutes

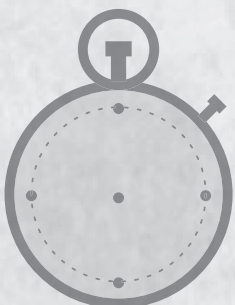

■ Essential Skills being practiced

- ✓ Thinking Skills – Significant use of memory
- ✓ Document Use

Tip:

Learners may be encouraged to discuss tips and tricks for memorizing information.

FOOD DETERIORATION – STUDY SHEET

Agent	Characteristics
Mould	Bluish-green color and hair-like fungal structure. Usually grows on bread, fruit and cheese.
Yeast	Plant microorganisms that are present in the air at all times. Cause fruit and vegetables to ferment and rot by changing the natural sugars into alcohol and carbon dioxide. Process done on purpose to make wines and beers. The production of carbon dioxide during fermentation causes bread to rise.
Bacteria	Usually the first agents to begin the decomposition process but are the hardest to detect. Usually not noticeable until the decomposition process advances to where the food product smells bad.

FOOD DETERIORATION – EXERCISE 1

Read the characteristics appropriate agent column and identify the:

Agent	Characteristics
	<p>Usually the first agents to begin the decomposition process but are the hardest to detect.</p> <p>Usually not noticeable until the decomposition process advances to where the food product smells bad.</p>
	<p>Bluish-green color and hair-like fungal structure.</p> <p>Usually grows on bread, fruit and cheese.</p>
	<p>Plant microorganisms that are present in the air at all times.</p> <p>Cause fruit and vegetables to ferment and rot by changing the natural sugars into alcohol and carbon dioxide.</p> <p>Process done on purpose to make wines and beers.</p> <p>The production of carbon dioxide during fermentation causes bread to rise.</p>

FOOD DETERIORATION – EXERCISE 1 - ANSWERS

Read the characteristics appropriate agent column and identify the:

Agent	Characteristics
Bacteria	<p>Usually the first agents to begin the decomposition process but are the hardest to detect.</p> <p>Usually not noticeable until the decomposition process advances to where the food product smells bad.</p>
Mould	<p>Bluish-green color and hair-like fungal structure.</p> <p>Usually grows on bread, fruit and cheese.</p>
Yeast	<p>Plant microorganisms that are present in the air at all times.</p> <p>Cause fruit and vegetables to ferment and rot by changing the natural sugars into alcohol and carbon dioxide.</p> <p>Process done on purpose to make wines and beers.</p> <p>The production of carbon dioxide during fermentation causes bread to rise.</p>

LESSON PLAN - FOOD DETERIORATION – WHAT DOES IT LOOK LIKE WHEN IT IS GOING BAD?



BASIC FOOD SERVICES & KITCHEN MANAGEMENT

From the kitchen of _____

■ Purpose and Practice:

- To review the changes that occur when food is deteriorating

■ Ingredients

Page 434
What does it look like when it is going bad? – Study Sheet

Page 435
What does it look like when it is going bad? - Exercise

Page 436
What does it look like when it is going bad? – Answer Key

■ Method

- Instructor prepares appropriate number of Study and Exercise sheets
- In small groups, learners read the study sheet
- Using the Exercise sheet, learners practice describing on their own describing what certain foods look like when they go bad
- Learners check their answers against the Answer Key

■ Cooking Time

20 minutes

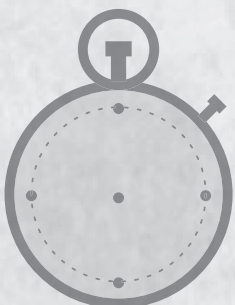

■ Essential Skills being practiced

- ✓ Thinking Skills – Significant use of memory
- ✓ Document Use

Tip:

Learners may be encouraged to cut the study sheet into study cards

FOOD DETERIORATION – WHAT DOES IT LOOK LIKE WHEN IT IS GOING BAD?

When food is deteriorating, you will notice changes in its color, odor, and taste:

Food Product	What does it look like when it's going bad?
Fruit	Goes soft, gets darker and quickly rots.
Vegetables	Start by wilting and then become slimy and rotten.
Butter, cheese and dairy products	Get darker and develop a sour smell.
Eggs	Become darker and smell bad.
Meat	Changes gradually at first, then becomes darker and begins to smell "off".

FOOD DETERIORATION – WHAT DOES IT LOOK LIKE WHEN IT IS GOING BAD? - EXERCISE

When food is deteriorating, you will notice changes in its color, odor, and taste. Identify what happens when the food products below deteriorate:

Food Product	What does it look like when it's going bad?
Eggs	
Vegetables	
Fruit	
Meat	
Butter, cheese and dairy products	

**FOOD DETERIORATION – WHAT DOES IT LOOK LIKE WHEN IT IS GOING BAD?
ANSWERS**

When food is deteriorating, you will notice changes in its color, odor, and taste. Identify what happens when the food products below deteriorate:

Food Product	What does it look like when it's going bad?
Eggs	Become darker and smell bad.
Vegetables	Start by wilting and then become slimy and rotten.
Fruit	Goes soft, gets darker and quickly rots.
Meat	Changes gradually at first, then becomes darker and begins to smell "off".
Butter, cheese and dairy products	Get darker and develop a sour smell.



LESSON PLAN - REDUCE – REUSE – RECYCLE METHODS

BASIC FOOD SERVICES & KITCHEN MANAGEMENT

From the kitchen of _____

■ Purpose and Practice:

- To review the meaning of Reduce-Reuse-Recycle and their differences

■ Ingredients

Page 438
Reduce-Reuse-Recycle – Study Sheet

Page 439
Reduce-Reuse-Recycle - Exercise

Page 440
Reduce-Reuse-Recycle – Sample Answers

■ Method

- Instructor prepares appropriate number of Study and Exercise sheets
- In small groups, learners read the study sheet and identify the difference between the 3 terms
- Using the Exercise sheet, learners write in their own words the differences between the 3 terms
- As a whole group, each small groups present what they have written

■ Cooking Time

30 minutes

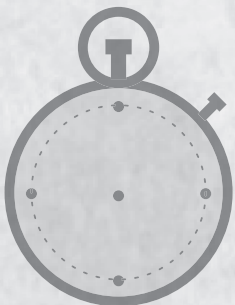

■ Essential Skills being practiced

- ✓ Reading Text
- ✓ Document Use
- ✓ Writing
- ✓ Working with Others
- ✓ Oral Communication

Tip:

Encourage learners to participate as a team and agree on what they will write. They may wish to take turns writing. This exercise works well as an individual exercise as well. The sample answers may be helpful too.

REDUCE – REUSE – RECYCLE METHODS - STUDY SHEET

Reducing solid wastes may seem like a difficult task, but it really is not. The food service industry uses a lot of packaging, so even a few basic re-use or recycling techniques can produce positive results even in a short time. Restaurants who focus on this task have been known to reduce their solid waste by as much as 50%.

Waste Management Terms:



Term	Description
Reduce	<p>This means looking for safe ways to avoid using unnecessary materials.</p> <p>Reducing will help to preserve resources, lower energy costs and reduce the demand for landfill space.</p>
Re-use	<p>This means looking in your workplace to identify and use safe products and materials that you can keep using over and over again.</p>
Recycle	<p>This means identifying and using products that can be collected and remanufactured so that the original raw material can continue to be useful rather than take up space in a landfill.</p>

REDUCE – REUSE – RECYCLE METHODS - EXERCISE 1 - SAMPLE ANSWER

To reduce is to find ways to limit the amount of material and packaging used in the workplace like using containers that can be washed instead of throw away storage containers.

To reuse means to find things in the workplace that can be reused over and over again, like stainless steel cutlery and coffee mugs instead of paper and plastic.

To recycle means using packaging materials that can be sent back to a manufacturer to break down and reuse the raw materials like breaking down cardboard boxes and having them picked up by a recycling company.



LESSON PLAN - REDUCE – REUSE – RECYCLE METHODS

BASIC FOOD SERVICES & KITCHEN MANAGEMENT

From the kitchen of _____

■ Purpose and Practice:

- To review job guidelines for working as a team toward effective waste management

■ Ingredients

Page 442
Study Sheet

Page 443
Interview Question
Exercise

Page 444
Interview Question
Sample question

■ Method

- Instructor prepares appropriate number of Study and Exercise sheets
- In small groups, learners read the RRR study sheet and discuss the value of the guidelines being presented
- Using the Exercise sheet, learners prepare sample questions about RRR that could be asked during an interview
- As a whole group, each small groups present their questions

■ Cooking Time

30 minutes

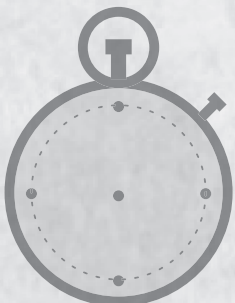

■ Essential Skills being practiced

- ✓ Reading Text
- ✓ Writing
- ✓ Working with Others
- ✓ Oral Communication

Tip:

This is a good opportunity to talk about the importance of asking questions during a job interview, particularly at the end.

WORKING WITH OTHERS TO REDUCE, REUSE AND RECYCLE IN THE WORKPLACE

Here are some on the job guidelines for a team approach to effective waste management:



1. Make sure that you understand your operation's overall goals for waste reduction and recycling and the in-house procedures that have been set up to achieve them.
2. Keep up with the changes. New products are always being developed like recyclable packaging and re-usable shipping containers. Your municipality or regional district may introduce other recycling systems that will be to your advantage.
3. Read all the information handouts and procedure manuals on waste management that your company distributes and attend all information meetings about new products and procedures.
4. If it is appropriate, be prepared to make suggestions about ways to reduce, re-use and recycle materials.
5. You are the one with the regular hands on experience with the products, and you are probably the first to see ways in which waste can be avoided. Some food service operations have incentive schemes to encourage employee input.

WORKING WITH OTHERS TO REDUCE, REUSE AND RECYCLE IN THE WORKPLACE

Questions to ask an Employer during an Interview

At the end of an interview, employers often ask if you have any questions. Brainstorm some questions that you could ask your prospective employer about reducing, reusing and recycling. A good employer will likely be impressed that you are interested in waste management practices:



WORKING WITH OTHERS TO REDUCE, REUSE AND RECYCLE IN THE WORKPLACE

Questions to ask an Employer during an Interview - Sample Questions



At the end of an interview, employers often ask if you have any questions. Brainstorm some questions that you could ask your prospective employer about reducing, reusing and recycling. A good employer will likely be impressed that you are interested in waste management practices:

1. What are your in-house procedures for waste reduction?
2. If I was to see ways to reduce, reuse and recycle materials at work to save money for your restaurant, how would I go about sharing my ideas?



BASIC BAKING

LESSON PLAN - FUNDAMENTAL RULE OF BAKING, FLOURS, FATS, STARCHES, LEAVENING AGENTS



From the kitchen of **BASIC BAKING**

■ Purpose and Practice:

- Reviewing material previously studied in class
- Working as a team to put together information that has meaning

■ Ingredients

Page 447
Fundamental Rule
of Baking

Page 448, Flours

Page 449, Starches

Page 450, Fats

Page 451, Starches

■ Method

- Instructor prepares appropriate number of review sheets for distribution after the exercise
- Instructor also prepares puzzle sets by cutting each sheet into puzzle pieces (cut along dotted lines) and separates the sets into envelopes or bags
- Class is divided into pairs or small groups and given a “puzzle set”
- In small group, learners put the puzzle pieces together so that the study sheets are complete
- Small groups reconvene and instructor distributes study sheets
- Instructor leads a discussion around the information contained in the study sheets.

■ Cooking Time

1 hour

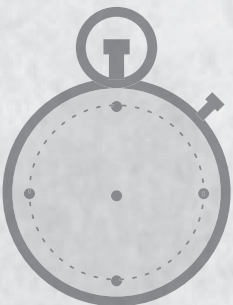

■ Essential Skills being practiced

- ✓ Working with Others
- ✓ Reading Text
- ✓ Thinking Skills

Tip:

Complexity level of the exercise can be adjusted by putting ALL of the puzzle pieces in one envelope, to 2 sheets of puzzle pieces to 1 sheet at a time. The size of the puzzle pieces can be enlarged or reduced depending on the complexity level desired as well.

Color code sets for easy sorting and re-setting for the next class.

Fundamental Rule of Baking

**There is one fundamental
rule in baking:**



Weigh all ingredients!

In baking, measurement is by weight, not by volume. For example, bake shop formulas (the bakery term for recipes) will call for flour in grams (ounces) or kilograms (pounds). This is quite different from home cookbook recipes that express measurement in cups, ounces, litres and millilitres.

Flours

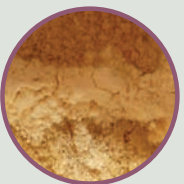

Flour is classified by its **protein** content. Flour proteins are important because of their **gluten forming potential**. Gluten is responsible for **volume, texture and appearance** of the baked goods. It provides structure and **helps retain the gas** produced by **leavening agents** when the flour and leavening are kneaded. Flours that are high in protein are called **strong flours**; those that are low in protein are called **weak flours**.

A baker is interested in three main categories of flour:

Bread flour

Pastry flour

Cake flour

Bread flour: high in protein (gluten forming potential)

Pastry flour: less protein than bread flour

Cake flour: has the least gluten of all three

The more gluten in a flour, the more liquid the flour is able to absorb.

Fats



The fats used in baking are often referred to as shortening because the action of the fat is to reduce (shorten) the effect of the gluten. A product that is high in fat content is called “short”.

The main fats used in baking are:

Butter, margarine, lard, and regular shortenings.

Starches



Starches are mainly used to **thicken** pudding, sauces, pie fillings and similar products.

Cornstarch thickened products set up like gelatin thickened ones so are useful to thicken cream pies and puddings that need to **hold their shape**. Cornstarch must first be dissolved in a cold liquid then introduced into a boiling liquid and cooked until the product boils again.

This is to remove the starchy flavour and to make sure that the starch is cooked.

Waxy maize and modified starches do not break down when frozen so are useful when preparing a **frozen product** or dessert.

A yellow circle with a purple border containing the text "baking soda" and "Baking Soda" in smaller text below it.

Leavening Agents

A yellow circle with a purple border containing the text "baking soda" and "Baking Soda" in smaller text below it.

Leavening agents are designed to **lighten the texture** and **increase the volume** of baked goods. They work by producing **carbon dioxide** when they come in contact with **moisture**. The **gas** causes the dough or batter to **rise** when (and sometimes before) the mixture is placed in an oven. Sometimes air trapped in the mixture by creaming batter or foaming eggs during the mixing stage is the leavening agent.

The most common leavening agents are **yeast, baking powder and baking soda**.

Yeast is a fungi organism that converts sugars into alcohol and carbon dioxide in a reaction called **fermentation**.

Baking powder consists of baking soda (bicarbonate of soda), a mild acid (cream of tartar), and usually a moisture absorber such as cornstarch. When baking powder is **mixed with a liquid**, carbon dioxide is produced which causes the batter to **rise**.

Baking soda produces gas bubbles when mixed with a liquid acid ingredient such as buttermilk, honey, molasses, and chocolate. Because baking soda **reacts instantly** with an acidic liquid, you should mix the baking soda with other dry ingredients before adding the liquid.



LESSON PLAN - BASIC PRINCIPLES OF BAKING - QUIZ CARDS

From the kitchen of **BASIC BAKING**

■ Purpose and Practice:

- To reinforce information previously learned using study cards and a group game

■ Ingredients

- Any ring toss, bean bag toss type game that will enable a two team challenge
- Page 453, 454, 455 Basic Principles of Baking Quiz Cards (3 sheets, 18 quiz cards total)
- Scissors (one pair per learner)
- One envelope per learner

■ Method

- Instructor prepares appropriate number of sets of review cards for each learner (3 sheets each, 3 quiz cards per sheet)
- Each learner receives a set
- Learners are instructed to cut out each quiz card along the dotted lines so that they have 6 cards per sheet and 18 cards in total, each set of cards is shuffled and tucked into envelopes (1 set per learner)
- Working in pairs, learners take turns: one pulls a card and asks the question while the other answer (hints are allowed!); halfway through the deck, learners switch roles until all questions have been asked
- Instructor then invites the learners to form 2 separate groups and challenge the groups to a ring/bean bag toss
- Instructor uses his/her own set of cards and takes turns asking each group a question For each successful answer, a team member tosses the ring or bean back and points are accumulated
- Instructor goes through all the questions, scores are tallied and a winning team is announced
- In the case of a tie, instructor re-shuffles the questions and continues on until the tie is broken

■ Cooking Time

1 hour



■ Essential Skills being practiced

- ✓ Working with Others
- ✓ Reading Text
- ✓ Thinking Skills

Tip:

Not all adult learners are comfortable with competitive challenges or games. Invite those individuals to be question askers and score keepers so that they are still involved.

Suggest that learners continue to use their set of questions throughout the program as study cards.

BASIC PRINCIPLES OF BAKING - QUIZ CARDS

Question:

What is the fundamental rule in baking?

Answer: Weigh all ingredients!

Question:

What is another word for a baking recipe?

Answer: A bake shop formula.

Question:

When it comes to measurement of quantities of flour, how are bakeries different from at home baking?

Answer: In a bakery, flour is weighed in grams/ounces or kilograms/pounds (as opposed to cups, litres, millilitres).

Question:

What is gluten responsible for?

Answer: Volume, texture and appearance of the baked good.

Question:

What are the 3 main categories of flour?

Answer: Bread flour, pastry flour, and cake flour.

Question:

Which type of flour is the highest in protein?

Answer: Bread flour

Question:

Which type of flour has the least amount of gluten?

Answer: Cake flour

Question:

Why are fats used in baking referred to as “shortening”?

Answer: Because the action of the fat is to shorten the effect of the gluten.

Question:

What are the 4 main fats used in baking?

Answer: Butter, margarine, lard, and regular shortenings.

Question:

What are starches mainly used for?

Answer: To thicken pudding, sauces and pie fillings.

Question:

How do you remove the starchy flavour from cornstarch and make sure that it is cooked.

Answer: First dissolved in a cold liquid, then introduced into a boiling liquid and cooked until the product boils again.

Question:

What is “waxy maize” used for?

Answer: Frozen products/desserts.

Question:

What do leavening agents do in baking?

Answer: They lighten the texture and increase the volume of baked goods.

Question:

What are the most common leavening agents?

Answer: Yeast, baking powder and baking soda.

Question:

What reaction happens when using yeast?

Answer: Fermentation

Question:

What happens when baking powder is mixed with a liquid?

Answer: Carbon dioxide is produced which causes the batter to rise.

Question:

What are 4 examples of liquid acid ingredients?

Answer: Buttermilk, honey, molasses, chocolate.

Question:

Why should you mix baking soda with other dry ingredients before adding a liquid?

Answer: Because it reacts instantly.



LESSON PLAN - PIE DOUGH – FILL IN THE BLANKS

From the kitchen of **BASIC BAKING**

■ Purpose and Practice:

- Reading material previously studied in class about using proper mixing techniques
- Remembering what was learned

■ Ingredients

Page 457
(learners' handout)

Page 458
(instructor's answer key)

■ Method

- Instructor prepares appropriate number of "pie dough" exercise sheets for the learners
- Individually, learners fill in the banks using the words provided to complete the passage.
- Instructor reviews the answers with the class in a group setting

■ Cooking Time

20 minutes

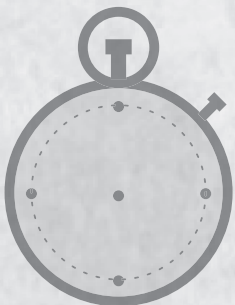

■ Essential Skills being practiced

- ✓ Document Use
- ✓ Reading Text
- ✓ Thinking Skills

Tip:

Encourage learners to strike off a word once it is used for easy tracking.

PIE DOUGH - EXERCISE

Even though pie crust involves just a few ingredients, the secret to making quality pie crust is in using proper mixing techniques.

Use the following words to fill in the blanks for the points to keep in mind when making pie dough:

flaky	30 minutes	small	rubbing
cold	wax paper	overwork	mealy

1. Cut the shortening into _____ pieces before _____ it into the flour.
2. Mix the shortening and flour to the proper consistency looking like coarse cornmeal for _____ dough or small nuggets the size of peas for _____ dough.
3. Use _____ water to bind the pastry. Do not _____ the dough.
4. Cover finished pastry with _____ or plastic wrap and refrigerate for at least _____ before rolling it out.

Remember: A quality pie will have:

- A golden brown appearance
- Fit the pan well
- Be tender and cut easily
- a texture that is flaky or mealy
- A neutral taste

PIE DOUGH - EXERCISE ANSWERS

Even though pie crust involves just a few ingredients, the secret to making quality pie crust is in using proper mixing techniques.

Use the following words to fill in the blanks for the points to keep in mind when making pie dough:

flaky	30 minutes	small	rubbing
cold	wax paper	overwork	mealy

1. Cut the shortening into small pieces before rubbing it into the flour.
2. Mix the shortening and flour to the proper consistency looking like coarse cornmeal for flaky dough or small nuggets the size of peas for mealy dough.
3. Use cold water to bind the pastry. Do not overwork the dough.
4. Cover finished pastry with wax paper or plastic wrap and refrigerate for at least 30 minutes before rolling it out.

Remember: A quality pie will have:

- A golden brown appearance
- Fit the pan well
- Be tender and cut easily
- a texture that is flaky or mealy
- A neutral taste



LESSON PLAN - WHAT HAPPENED TO MY PIE CRUST?

From the kitchen of **BASIC BAKING**

Purpose and Practice:

- To review the various negative characteristics of a pie crust and the probable cause of this characteristic

Ingredients

Page 460
 What happened to my pie crust?
 – Study Sheet

Page 461
 What happened to my pie crust?
 – Phrase Match Exercise

Method

- Instructor prepares appropriate number of Study sheets for the learners
- Using the Phrase Match Exercise sheet, the Instructor prepares 3 or more sets by cutting the sheet into smaller cards (characteristics and probable causes)
- Instructor “shuffles” the cards and places them in an envelope
- In small groups, the learners work together to match a characteristic to its matching probable cause
- Once completed, the instructor hands out the study sheet so that the learners may check their answers

Cooking Time

20 minutes

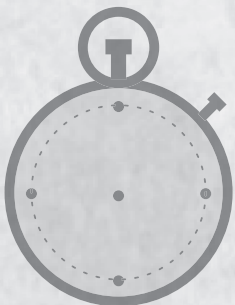

Essential Skills being practiced

- ✓ Thinking Skills
 – Significant use of memory
- ✓ Document Use

Tip:

Learners may be encouraged to cut the study sheet into small cards so that they may practice the matching exercise on their own

WHAT HAPPENED TO MY PIE DOUGH?

Characteristic	Probable Cause
Crust has a very dark colour	Crust overbaked or baked at too high of a temperature.
Crust is white or pale in colour	Crust probably undercooked or handled too much during preparation.
Crust has shrunken in size	Crust may have been overstretched when lining the pie pan or dough not allowed to rest before baking.
Crust is too flaky	Crust may have been poorly mixed, have too much shortening or too little liquid.
Crust is not tender but tough	Crust may have been handled too much or may contain too much liquid.
Crust is quite dry	Crust may have been overmixed, shortening cut too fine or too little liquid used.
Crust is dense in texture	Crust probably undercooked or too much liquid used.
Crust has an off-taste	Crust may have been made with inferior quality (rancid) shortening.
Crust tastes burnt	Crust has been overcooked.

WHAT HAPPENED TO MY PIE DOUGH? - PHRASE MATCH EXERCISE

 <p>Crust has a very dark colour</p>	<p>Crust overbaked or baked at too high of a temperature.</p>
 <p>Crust is white or pale in colour</p>	<p>Crust probably undercooked or handled too much during preparation.</p>
 <p>Crust has shrunk in size</p>	<p>Crust may have been overstretched when lining the pie pan or dough not allowed to rest before baking.</p>
 <p>Crust is too flaky</p>	<p>Crust may have been poorly mixed, have too much shortening or too little liquid.</p>
 <p>Crust is not tender but tough</p>	<p>Crust may have been handled too much or may contain too much liquid.</p>
 <p>Crust is quite dry</p>	<p>Crust may have been overmixed, shortening cut too fine or too little liquid used.</p>
 <p>Crust is dense in texture</p>	<p>Crust probably undercooked or too much liquid used.</p>
 <p>Crust has an off-taste</p>	<p>Crust may have been made with inferior quality (rancid) shortening.</p>
 <p>Crust tastes burnt</p>	<p>Crust has been overcooked.</p>



LESSON PLAN - COMMON TYPES OF PIE DOUGH

From the kitchen of **BASIC BAKING**

Purpose and Practice:

- Learner`s will review 3 types of pie dough and their unique ingredients

Ingredients

Page 463
(study sheet)

Page 464
(exercise sheet)

Page 465
(answer key)

Method

- Instructor prepares appropriate number of study sheets for "Common types of pie dough".
- Learners complete the exercise sheets on their own or in groups
- Come together as a whole class to review matches

Cooking Time

30 minutes

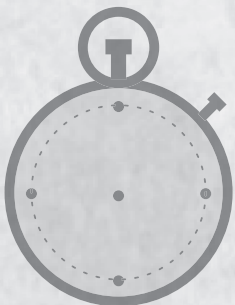

Essential Skills being practiced

- ✓ Reading Text
- ✓ Thinking Skills
- ✓ Document Use
- ✓ Working with Others
(if exercise is done in a group setting)

Tip:

sheets can be cut into "type and description" study cards to improve memory.

COMMON TYPES OF PIE DOUGH - STUDY SHEET

Types of Pie Dough	Description
Basic Pie Dough	<p>Mixture of butter and shortening as the fat. Other ingredients include sugar, salt and eggs.</p> <p>Example: tarts and pie dough</p>
Sugar Dough	<p>Mixture of flour, sugar, baking powder, butter and egg.</p> <p>Example: fresh fruit tarts</p>
Hot Water (English Raised) Pastry	<p>Mixture of lard (or margarine) and water brought to a boil and flour is stirred in and mixed as well. Mixture is turned onto a floured board and kneaded.</p> <p>Example: meat pies</p>

COMMON TYPES OF PIE DOUGH - EXERCISE

Read the pie dough description and write the type of pie dough in the space provided:

Types of Pie Dough	Description
	<p>Mixture of lard (or margarine) and water brought to a boil and flour is stirred in and mixed as well. Mixture is turned onto a floured board and kneaded.</p> <p>Example: meat pies</p>
	<p>Mixture of butter and shortening as the fat. Other ingredients include sugar, salt and eggs.</p> <p>Example: tarts and pie dough</p>
	<p>Mixture of flour, sugar, baking powder, butter and egg.</p> <p>Example: fresh fruit tarts</p>

COMMON TYPES OF PIE DOUGH - ANSWERS

Read the pie dough description and write the type of pie dough in the space provided:

Types of Pie Dough	Description
<p style="text-align: center;">Hot Water (English Raised) Pastry</p>	<p>Mixture of lard (or margarine) and water brought to a boil and flour is stirred in and mixed as well. Mixture is turned onto a floured board and kneaded.</p> <p>Example: meat pies</p>
<p style="text-align: center;">Basic Pie Dough</p>	<p>Mixture of butter and shortening as the fat. Other ingredients include sugar, salt and eggs.</p> <p>Example: tarts and pie dough</p>
<p style="text-align: center;">Sugar Dough</p>	<p>Mixture of flour, sugar, baking powder, butter and egg.</p> <p>Example: fresh fruit tarts</p>



LESSON PLAN - UNBAKED AND BAKED PIES

From the kitchen of **BASIC BAKING**

■ Purpose and Practice:

- Learner`s will review the unique characteristics of unbaked and baked pies

■ Ingredients

Page 467
Unbaked and
baked pies study
sheet
Page 468
Unbaked and
baked pies
questionnaire
Page 469
Unbaked and
baked pies answer
key

■ Method

- Instructor prepares appropriate number of study sheets for “Unbaked and baked pies”
- Learners review the study sheet.
- Learners complete the questionnaire on their own or in small groups
- Come together as a whole class to review matches

■ Cooking Time

30 minutes

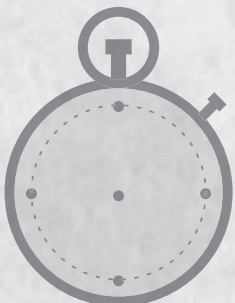

■ Essential Skills being practiced

- ✓ Reading Text
 - ✓ Thinking Skills
 - ✓ Document Use
 - ✓ Working with Others
- (if exercise is done in a group setting)

Tip:



UNBAKED AND BAKED PIES - STUDY SHEET

There are two types of pies: unbaked and baked

Unbaked Pies	Baked Pies
<ul style="list-style-type: none">• Uses a pie crust that has been baked• Pie is served after the filling has set• Cream pies are unbaked pies• When baking a pie crust without a filling, the pie shell should be pricked with a fork and fitted with a paper liner that can be filled with dry peas, dry beans or uncooked rice.• This process is called “baking blind” and prevents the crust from blistering while it is baking.	<ul style="list-style-type: none">• Uses a pie crust that is unbaked.• Sometimes a partially baked crust is used• Examples of baked pies include: pumpkin, pecan and fruit.

UNBAKED AND BAKED PIES - QUESTIONNAIRE

1. Name two types of pies?

2. What kind of pie crust do you use for an unbaked pie?

3. When do you serve an unbaked pie?

4. When would you use the “baking blind” process? Describe this procedure.

5. What is an example of an unbaked pie?

6. What kind of pie crust does a baked pie usually start with?

UNBAKED AND BAKED PIES - ANSWERS

1. Name two types of pies?

Baked and Unbaked.

2. What kind of pie crust do you use for an unbaked pie?

A baked pie crust.

3. When do you serve an unbaked pie?

When the filling has set.

4. When would you use the “baking blind” process? Describe this procedure.

Lining the shell with wax paper and filling it with dry peas, beans or uncooked rice.

5. What is an example of an unbaked pie?

Cream pie.

6. What kind of pie crust does a baked pie usually start with?

Usually an unbaked pie crust.

LESSON PLAN - QUICK BREADS – MUFFIN METHOD & BISCUIT METHOD



From the kitchen of **BASIC BAKING**

■ Purpose and Practice:

- Learner`s will review and compare the 3 step Muffin and the 5 step Biscuit methods

■ Ingredients

Page 471
Muffin and Biscuit
method study
sheet

Page 472
Muffin method
sorting cards

Page 473
Biscuit method
sorting cards

■ Method

- Instructor prepares appropriate number of study sheets for “Quick Breads – Muffin method and biscuit method” study sheet
- Learners review the study sheet.
- Learners cut the sorting cards into steps, shuffle and arrange in order
- Come together as a whole class to review matches

■ Cooking Time

30 minutes

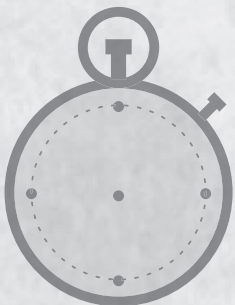

■ Essential Skills being practiced

- ✓ Reading Text
 - ✓ Thinking Skills
 - ✓ Document Use
 - ✓ Working with Others
- (if exercise is done in a group setting)

Tip:

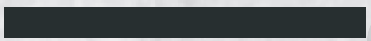

QUICK BREADS – MUFFIN METHOD AND BISCUIT METHOD STUDY SHEET

Quick breads do not use yeast as a leavening agent. Quick breads rise because of the aerating action of baking powder, baking soda or eggs. The word “aeration” describes the process of allowing air to be combined into ingredients to make them lighter and/or create more volume.

There are two main methods for mixing the ingredients used in quick breads – the muffin method and the biscuit method.

The Three Step Muffin Method

1. Mix the dry ingredients (including powdered milk if it is used) in a bowl.
2. Combine liquid ingredients such as eggs, milk and melted fat in a separate bowl.
3. Add the liquid ingredients to the dry ingredients and mix only enough to dampen the dry ingredients even though the mixture will be lumpy.

The Five Step Biscuit Method

1. Mix the dry ingredients in a mixer bowl.
2. Add the fat to the dry ingredients and cut it in with a pastry knife attachment or by hand.
3. Combine liquid ingredients in a separate bowl.
4. Add liquid to dry ingredients and mix to make a soft dough.
5. Knead the dough gently to develop the gluten. Do not overknead as this will toughen the dough and biscuits.

QUICK BREADS – MUFFIN METHOD EXERCISE

Arrange the following methods in order by step:

Mix the dry ingredients (including powdered milk if it is used) in a bowl.

Combine liquid ingredients such as eggs, milk and melted fat in a separate bowl.

Add the liquid ingredients to the dry ingredients and mix only enough to dampen the dry ingredients even though the mixture will be lumpy.

QUICK BREADS – BISCUIT METHOD EXERCISE

Arrange the following methods in order by step:

Mix the dry ingredients in a mixer bowl.

Add the fat to the dry ingredients and cut it in with a pastry knife attachment or by hand.

Combine liquid ingredients in a separate bowl.

Add liquid to dry ingredients and mix to make a soft dough.

Knead the dough gently to develop the gluten. Do not overknead as this will toughen the dough and biscuits.



References

Attributions

Page #	Image Title & Link	Author	License Title
Cover	<p>JOH_0500.jpeg</p> <p>https://www.flickr.com/photos/johnjoh/6079842006/in/photolist-agfMdb-dtcMg2-dtcYG9-dtcXNS-85Dkkg-283wGh-8Loyag-aoXWWy-92fdZh-hQ4wa-5KiTkd-6WxqY-5KiT2b-cuTUfo-8jXVaB-cDXnVf-7zTdg1-5KiUJf-j3D639-LEP1i-q9My9B-6vhA88-s8QtaB-6WtnDt-6FqczE-92c7b2-cDXq8w-cDX6XE-dnRNcd-cDX5zb-dozFGu-aZYMo-65Hp7T-cuTVWh-cDXiA1-7XDixV-6WxpYQ-GKfM-5K5kBX-aSnxgP-5KiXfd-aSnxv-8z9Dn-4hVDVi-fweEbv-92NVcg-8PhPPN-ooPx8B-bb3f8k-779gyQ</p>	<p>star5112</p> <p>https://www.flickr.com/photos/johnjoh/</p>	<p>Attribution-ShareAlike 2.0 Generic (CC BY-SA 2.0)</p> <p>https://creativecommons.org/licenses/by-sa/2.0/</p>
21	<p>chef.jpg</p> <p>https://www.flickr.com/photos/ericmcgregor/349775558/in/photolist-wUG65-64FxaP-6ttNze-4hVDVi-7XDj2a-9M7vpb-fweEbv-yhECi-92NVcg-6WtmuM-8PhPPN-9FDJh-dtcYv9-ooPx8B-C7bs93-Gq62N-29wYTo-GKgG-cDXu49-5dW2r3-5xq59N-9NfHpy-cDXs8s-cDXgx1-aqEo2K-625SdU-rbWUoE-8UxXS1-dYgNFz-dtcMbi-fGmqTA-7gsfeG-cDXeHb-7WLRBD-779gyQ-8GZo9D-rtvtw8-cDX8dS-dtLZT-6Q2Pc8-dtLX8-8H3vN1-heF1z9-4SGj3f-oxegfZ-cvYzju-c6QtQh-92fdNS-6LsbB7-bb3f8k</p>	<p>Eric McGregor</p> <p>https://www.flickr.com/photos/ericmcgregor/</p>	<p>Attribution 2.0 Generic (CC BY 2.0)</p> <p>https://creativecommons.org/licenses/by/2.0/</p>
36, 37, 38	<p>Pinterest Chef Retro</p> <p>https://www.flickr.com/photos/mkhmarketing/8539332685/in/photolist-e1Aj6T-5KiTkd-aBA6JJ-7LzYys-e1FY7m-7RzaQd-57J5Co-5KiXfd-ocCoCm-augtuf-cPfp75-qNQ8QG-ekeRDi-augtDf-4DfBR6-qnvZr9-8tKMw2-8tKM6f-eMmNUL-ofyKlZ-6g1k8n-4qZoaT-nz97NS-bkwKsv-3KjZVD-a6BM2e-iCRK9Z-cxJmC-coEqD3-63iEfC-5K9B9y-peSCmF-5ww1yt-5wAxxE-9qPcmv-6qvjZb-5Kd9Qz-8GEv6J-Cjfn98-juLSJG-5www2zH-8CgCtf-iywHN5-5ww1aR-7pyWt8-4DfBTc-com1vy-btNoES-o5o5W-iySTLU</p>	<p>mkhmarketing</p> <p>https://www.flickr.com/photos/mkhmarketing/</p>	<p>Attribution 2.0 Generic (CC BY 2.0)</p> <p>https://creativecommons.org/licenses/by/2.0/</p>
39	<p>Fresh_Vegetables</p> <p>https://www.flickr.com/photos/121843045@N05/13565614893/in/photolist-mEKJFX-pHAARu-4ovjyU-ac3WwL-6s42rC-nsPQnj-hR8HSp-8Ss3zv-8xECEE-2kLHoF-dmoTgr-55VZbX-ajSmZu-bpmGzh-ahoQWk-9tb5Ex-d2QFDJ-ej3F6r-9X4DWN-jcRzMV-6jJQy5-oAXwSJ-cvb4n5-9eUx4H-ffATie-pr39by-5XFL7J-6jED5P-vC5xJN-ihtTHM-iffHagE-ahS81G-fCpI5V-7ZNced-8NGmvt-9tb3SX-c9ADWs-baM2A6-kfmG8z-6jECSp-8kasJv-6DnSq2-5h9yzc-a4uUin-bpHfaZ-2htkjG-oEPbQb-cyy2a9-miLnet-5HK2c</p>	<p>mahmoud99725</p> <p>https://www.flickr.com/photos/121843045@N05/</p>	<p>Attribution-ShareAlike 2.0 Generic (CC BY-SA 2.0)</p> <p>https://creativecommons.org/licenses/by-sa/2.0/</p>
44, 45	<p>Chef</p> <p>https://www.flickr.com/photos/clickme/9397350764/in/photolist-fjpSZ3-q3BWRo-qXkaHd-cDXnVf-8z9Dn-dtw8bb-AXynGX-8acNkm-8acJ9U-6a4qbA-qH6erw-eaSSr-a5imZD-6eMeAW-5VEfUS-nDR4p1-aSDSUD-8AQBR5-4a6Rh-q3BYG7-q3RQba-cuTWDW-4vxvdh-b9MsAz-oAk1gB-7foJiG-7ZwbbZ-akWjs6-9iwNZj-oyirbk-83Gjz5-naQUvt-oAk1cP-6rLuw2-4pkGSM-oh6mrr-6kdB9w-aqEo2K-24Eyyv-5xq59N-cmi5xN-9CiMQP-bkwKsv-7ijQsP-njigs-9b1aBR-qZxxXd-7QuKAU-oh5Kin-qHdV5c</p>	<p>Hani Arif</p> <p>https://www.flickr.com/photos/clickme/</p>	<p>Attribution 2.0 Generic (CC BY 2.0)</p> <p>https://creativecommons.org/licenses/by/2.0/</p>

Page #	Image Title & Link	Author	License Title
46	20120106-OC-AMW-0073 https://www.flickr.com/photos/usdagov/7008315173/in/photolist-bFirWe-fjG9Py-ieWXY4-o4QNaw-atCQJM-ieX3bx-dAMNo9-ieWUwC-fjrZsp-ieX82V-ieWY5j-ieX6XR-4GvEgx-ieWkbP-r5kRf3-ieWRJw-ieX6zC-ieWQ6o-ijJmmM-bFis4D-ieWvWM-ieWAeV-qDM5bC-62g9Pz-ieX15S-ieX1K6-e8y8Yd-q5DmCS-atBhVt-bsoy1s-47EDZ6-ieX9N1-bsozpd-e5YUye-puowpV-fjGamh-bFir8P-a4UFDb-cN6fbS-bxpNnW-bxnNN-i-atDSNU-o54gg6-bn7U6X-pXCgRZ-ifNdhX-9VHTP7-fDx8fH-fjGbcf-fjrZ3r	U.S. Department of Agriculture https://www.flickr.com/photos/usdagov/	Attribution 2.0 Generic (CC BY 2.0) https://creativecommons.org/licenses/by/2.0/
63	Dish & Kitchen Cleanliness Chef Andrew George	MSEC	Images are with permissions.
81	Rösle Utensils https://www.flickr.com/photos/dinnerseries/5262022442/in/photolist-4959V7-672dLk-91ZeWS-64qF39-583CbP-4kA9az-91HD8J-dxetD4-dwxuAH-9Es5Zm-o38p2k-gPVPPh-pW48St-biwekM-biwem8-biwekv-5qxRyw-orF5Qw-neGn-by2i59-evqtXD-ntEn61-4cTbKl-r4AoPC-6GR2BA	Didriks https://www.flickr.com/photos/dinnerseries/	Attribution 2.0 Generic (CC BY 2.0) https://creativecommons.org/licenses/by/2.0/
92	Japanese fisherman knife - Makiri Houchou https://www.flickr.com/photos/danieltoschlaeger/9603952206/in/photolist-fCELoS-3Tvh9R-8SCe6v-dXQM1K-9Ej6JB-93vDek-gh5RCq-cGVvF1-dXuyjs-dXgcbj-6e6wQV-dXWFnf-5F7y5Y-dXauKx-93yKr3-9uS1eC-dXoJRZ-dXoMur-FWVwbn-dXQKZg-6iEMGh-9J1SA5-5tnsmi-rTUGph-bWBvW5-aoRkPk-qkDuTx-EbdjmG-dyfvui-q9gPRS-eSnUwn-E4Ra8D-aoUyUy-5dzTRy-BjmazJ-dya2Yx-6Rn4Wg-rTTv5d-sjzRz1-CH2KS4-AWnyAD-wYd8V-5tnsZB-dXuNVL-ekqpDH-5tnu1F-dXex5M-oWUHka-cGvYWY-DhecBu	tlwmbdt https://www.flickr.com/photos/danieltoschlaeger/	Attribution 2.0 Generic (CC BY 2.0) https://creativecommons.org/licenses/by/2.0/
92	Stainless Steel https://www.flickr.com/photos/dominicsayers/7782286/in/photolist-FTpM-8BAVhn-8BAVct-8BAVm6-8BAV5x-ptHjz3-7H7uvZ-f7oS4E-dqc9vQ-hTWhrb-hTWNFM-hTWoBf-hTWnZo-hTVPYv-hTVKsM-hTWjGm-hTVMda-hTWijj-hTWkFN-gjGQXX-fqWtb4-7AJU7T-4rvrt4-eQjCWF-qKTcEx-hTWe3W-hTWQQM-hTWp6G-gkLC4s-hTWgkb-c25hU7-hTVNir-hTWdgC-kGRkgv-hTWaS-cZuZym-5PqqQ-hTVGwX-hTWMmn-cEpVnJ-5SNpHH-f7p1NL-6338Hj-gBJw2L-eZwXjU-nen3S2-kpe6T-qPcxJq-6WTFui-ffM5Yx	Dominic Sayers https://www.flickr.com/photos/dominicsayers/	Attribution 2.0 Generic (CC BY 2.0) https://creativecommons.org/licenses/by/2.0/
92	Morakniv Classic 1891 https://www.flickr.com/photos/hepp/17009763111/in/photolist-rV6tXM-9ss1Qo-9s8JH1-eEyWap-8QqhcM-d9VGXj-9qrbMR-9qce8S-9rMQs7-9pVAT6-nMX9nJ-5WY6xr-5MTGaJ-cTMnyU-ratp4c-8EKsSk-q3T9E2-7BMTj9-7AGi1t-8zRqru-8uRCPH-9srZBF-rCB3eJ-d9VHM1-8QAmVG-difCKd-8t56XU-dvkA8M-5WCmYG-gww71J-fp1SUY-dSZSXR-69CiD4-aWvZKK-dT6tHA-fj4Qri-dKriN1-dT6tC1-5VS6Ut-bBPj9v-fj4QuP-KKBCV-difEXD-b2WjD2-difEYB-aMdd2g-64bs9-7M9pkE-8UyFzN-dKrn2y	erik forsberg https://www.flickr.com/photos/hepp/	Attribution 2.0 Generic (CC BY 2.0) https://creativecommons.org/licenses/by/2.0/
92, 93, 94	Wusthof 8" Classic Chef Knife https://www.flickr.com/photos/silwenae/9924506916/in/photolist-g7ZG9d-AwjM-y-r5AVTD-aDX1vd-g7Ai77-dtdmWT-7oeJwn-baVgPV-ucgft-qCLeh-heF1z9-nwDQbQ-4chdYK-r5yNzK-aDT8Uk-oUNEH8-2vQs2n-8RHi5V-7JbFrW-bPqyrv-fgQFf-at3tGe-2U27bC-aU8hkp-76N1ke-4XNH91-vrx2f-cePWwb-vrxeh-7Bt55J-6ju66h-7x9eqf-6X13dK-qx55NP-9ip5AT-6jpWq4-6jpYDx-f9XQo-9isbAJ-6jpUAp-6jq4w6-8PM8Z-f6joBan-kZb8HW-6jsMkG-bsM83n-6LgSVf-6ju7fW-kPmJE9-fPaTEB	pcutler https://www.flickr.com/photos/silwenae/	Attribution-ShareAlike 2.0 Generic (CC BY-SA 2.0) https://creativecommons.org/licenses/by-sa/2.0/

Page #	Image Title & Link	Author	License Title
93	4582456465054-64 https://www.flickr.com/photos/thinkhub/24234647310/in/photolist-DfnCyR-CVwTCU-Dd5F97-Cqg8PD-Cq94J9-DnDEWr-Cq93L7-DnEqyg-DnEoNn-DkmcC5-Dd6qoo-DnEqCe-CPaxrt-Dkmc8C-DnEphZ-DkmbKd-DnEoGR-Dd6oob-Cq9L7y-Dfom7v-DnEnuv-DnDEtH-DkkrfY-Cq93h1-Cqg9Gk-Cqg9nn-Cq94jm-CVwUjJ-DnEp7P-CVwViC-CP9MRc-DfnDut-DfnDji-Cq93uL-DkkqYW-DkkqXJ-Dd5Ezb-Cq94Fy-DfnCTi-DfnEhR-CVwV4j-CP9LzK-CP9LpK-Dd5Erf-DnDEG8-CVwUXN-sDsFz6-tFpTAK-tFp65Z-niUoy6	MJY-shogun https://www.flickr.com/photos/thinkhub/	Attribution 2.0 Generic (CC BY 2.0) https://creativecommons.org/licenses/by/2.0/
100	Cooking https://www.flickr.com/photos/worldskillsteamuk/8194525872/in/photolist-du863Q-6P6ujs-4X5vAD-8z9Dn-kxqbS9-qNQ8QG-is-F4KZ-751W41-9gZEB7-aLWqdB-jr3U6u-du855d-f98gop-4f5JzJ-aszNBo-kwGXNM-dyfyN3-j3D639-oT4gn-9JEvKr-91W6c6-jr3NkG-2jdTXW-ho5xQR-a3VVUC-DZyFA-7ZiRZP-jr3mfl-ncl6HZ-4X5vV4-du2uxM-zsUEZ-nNf7QS-ek9hGH-bFZ6B-chf5vm-eRgX3h-7zPvVx-csgx9o-bDNAgn-7FeVZL-92c7b2-paufQQ-wwu1S-ajPTVL-c5ezAW-bqTD51-eMhvUB-dELWJV-cuTSTY	WorldSkills UK https://www.flickr.com/photos/worldskillsteamuk/	Attribution 2.0 Generic (CC BY 2.0) https://creativecommons.org/licenses/by/2.0/
100	making sandwiches https://www.flickr.com/photos/r4andred/3329193066/in/photolist-65bZ7s-6LUMZ7-fJU3Xj-34uqqG-dWqwZX-8jvNiP-4LbQc4-5VVA5C-cfWdUw-fD5zd8-myQzY7-aA2rR-b3S5g6-2euweW-dWqwTn-dugWCt-8QqhcM-wNGjm-vTAE7g-4Kv2jd-8wLE3K-2jW4TW-5LcEyr-e4KyGb-7vFYAf-8BwLhG-aQybtK-8LG7cV-Lsdm-i110yp-7yNfp1-4jMmLJ-8NNvFG-cUb1vQ-afjnoe-7yJtpH-7GfCtr-9955qW-uH2zg-axenEm-4Rp626-bSi26f-qQZubb-8zenjZ-4KBSSG-57ECh1-dieQmw-4jH21K-8e9Z2M-f9Wm2i	redazadi https://www.flickr.com/photos/r4andred/	Attribution 2.0 Generic (CC BY 2.0) https://creativecommons.org/licenses/by/2.0/
100	Bakery https://www.flickr.com/photos/86083886@N02/8156987002/in/photolist-dqNG3W-dqNwwa-89jfm8-dqNyK2-8y9Eqd-dqNGEQ-dqNy1g-qv6vUe-fjw6RK-dqNy7k-dqNxGn-jfQwj-qsZbdE-fkDP7q-7RXJio-dPrFF4-qxRXES-fkyD8m-pnaaAn-fjyNWN-fh2JQa-adEgp-4rYU7K-bydSJT-aQWFB2-dqNBjc-67CRMg-jYmqrv-8Wbhaw-8RpaCn-7K1QUp-oWauZF-a5qXqY-btemB7-6XRrs8-iUvYe1-H5wJbX-5rjNAV-o4LiNL-93fEef-dqNw8M-qsZaT1-b7ogfB-qdHoBY-7kt6c3-859R7m-aZqwQV-dqNxpZ-7B5Dv9-7NRPAo	StateofIsrael https://www.flickr.com/photos/86083886@N02/	Attribution-ShareAlike 2.0 Generic (CC BY-SA 2.0) https://creativecommons.org/licenses/by-sa/2.0/
100	Banquet on first night of ALIEP 2013 https://www.flickr.com/photos/candy-s/9896127934/in/photolist-g5uf4q-mKYy6c-mKZ3MK-rertRs-drvG5v-ob8xFx-oS55cY-mL1LtQ-dCEAoS-drvLVT-dCEAtf-aYpMB2-dCEArE-drvE2D-4X9s7P-osET2b-mKYXRz-drvLYj-pNFUhd-8UTBNV-dCzaBr-7qqHdo-dCEAZs-74ptjS-92ztq4-mKYWdV-qE1QGU-6iKBJk-rS13d7-rhG3Ax-pS9GdL-eWcTna-2S1Umm-rAUJQH-ryHVoA-fMrxEB-qEefmn-6iKxWK-6iPPXL-rAUNSS-rB1mVH-bYXMVY-yvfUP-rAUNiz-rAULGt-6iKAok-6iPHfC-8iWWMir-eE31i8-drvF6V	candyschwartz https://www.flickr.com/photos/candy-s/	Attribution 2.0 Generic (CC BY 2.0) https://creativecommons.org/licenses/by/2.0/
100	Train Chartering - The Royal Canadian Pacific kitchen https://www.flickr.com/photos/14589121@N00/3613197553/in/photolist-4MDwwX-6P66vu-a4RgPc-c6herU-s84dtC-dyPseZ-aMhrGK-cDXwj3-3kzmR-9qiMxV-4K95yp-qXxddu-9qn9yy-6Q6tyY-Dsst4-GE6eY-9B5N4z-fbDnTx-6vzhKx-cDXkc9-4PeReE-6vmDaJ-8KLGMB-Merav-nVcYsC-83Zmmj-GE6uw-93kQ2Y-Aq4yr-8tCZSQ-dgGkju-7K85Xg-6SmftT-bW3rdT-4Kdk8o-2MZ75n-7uqWjs-agcVqR-2pZjTS-dnRGya-6vhsLc-9isbDN-6ep9y6-bDhhCH-bqnogj-bEP3zN-9NUnuy-9NUnhA-9TWibV-4f5JzJ	Simon Pielow https://www.flickr.com/photos/14589121@N00/	Attribution-ShareAlike 2.0 Generic (CC BY-SA 2.0) https://creativecommons.org/licenses/by-sa/2.0/

Page #	Image Title & Link	Author	License Title
100	4582456465054-64 https://www.flickr.com/photos/thinkhub/24234647310/in/photolist-DfnCyR-CVwTCU-Dd5F97-Cqg8PD-Cq94J9-DnDEWr-Cq93L7-DnEqyg-DnEoNn-DkmcC5-Dd6qoo-DnEqCe-CPaxrt-Dkmc8C-DnEphZ-DkmbKd-DnEoGR-Dd6oob-Cq9L7y-Dfom7v-DnEnuv-DnDEtH-DkkrfY-Cq93h1-Cqg9Gk-Cqg9nn-Cq94jm-CVwUjJ-DnEp7P-CVwViC-CP9MRc-DfnDut-DfnDji-Cq93uL-DkkqYW-DkkqXJ-Dd5Ezb-Cq94Fy-DfnCTi-DfnEhR-CVwV4j-CP9LzK-CP9LpK-Dd5Erf-DnDEG8-CVwUXN-sDsFz6-tFpTAK-tFp65Z-niUoy6	MJY-shogun https://www.flickr.com/photos/thinkhub/	Attribution 2.0 Generic (CC BY 2.0) https://creativecommons.org/licenses/by/2.0/
100	Bar https://www.flickr.com/photos/daquellamana/6765792997/in/photolist-biSsxp-rqjfae-puNxnA-8prNQ1-9U3RJq-r1Yr5t-8HXhk-pdjre2-NJGnG-9cmut7-767YAq-9RWUVV-qZfxdR-Kca2i-9dKXGe-7qtqZ-qJfGyx-wR6pB-fkAXQk-4fyVd-de52AA-59KLid-phG7y8-6BZgn8-eTtwsM-8Hgnmy-fqp1s-4w6u1t-5VaTGH-npk6x8-aEZTPo-9TUYQW-4EUaAw-eeenat-fkV9Wj-irJMvp-oTaPuT-6enbCc-9w7tpr-8C18jW-23D9U-Kc1Dj-7VLKAW-EXpg38-6dZhfX-9oecWo-4Wyi1R-arRiSz-56SPzG-oqWN7K	Daniel Lobo https://www.flickr.com/photos/daquellamana/	Attribution 2.0 Generic (CC BY 2.0) https://creativecommons.org/licenses/by/2.0/
105, 106	Mauviel Copper https://www.flickr.com/photos/dinnerseries/14411031471/in/photolist-bZ7gyj-6hBE2n-nXsizr-Gp2XhM-nXsiBp-bmMEQK-bmMqXk-7xTf8S-aGXdwi-qJkfWR-qyZnRA-zEmMwD	Didriks https://www.flickr.com/photos/dinnerseries/	Attribution 2.0 Generic (CC BY 2.0) https://creativecommons.org/licenses/by/2.0/
108, 109	R0029992rtgc https://www.flickr.com/photos/pollobarca/4752466525/in/photolist-8eXCJ2-owlWji-ofgCTu-8g6P61-6QnnQZ-8eXtBv-8f22wN-8f1S9j-zdH9z7-un8kav-GmFh6L-8f2wB1-8eXwAV-56dKaG-56dJQC-oh9R5W-8f2eAJ-8eXrkn-6bGBSF-8f2m2y-395bSX-8f2oe5-8eYbFP-8f1TKA-8ffRbY-8fcBii-8f2ksf-8fctep-8eY32z-8f29vd-8ffUD5-8eY2iB-8eXZWv-8ffD5E-8f2aPE-8eY5qM-8eY89P-8f2vLS-8f2dAd-8eYcZg-8fcuVp-8ffHiJ-8eXVgx-8f2oKd-8eY5Wg-8fcKzM-8ffU9C-8eY1Gi-8fcDKP-3eFnCc	Paul Barker Hemings https://www.flickr.com/photos/pollobarca/	Attribution-ShareAlike 2.0 Generic (CC BY-SA 2.0) https://creativecommons.org/licenses/by-sa/2.0/
111, 112	Hahn 28cm Non Stick Buffet Saute Pan https://www.flickr.com/photos/cooks-and-kitchens/5023481258/in/photolist-6S6Ni-6S6Nh-bmMqXk-7xTf8S-8DUDXQ-otbaeQ-64bpQP-7fDizw	Cooks & Kitchens https://www.flickr.com/photos/cooks-and-kitchens/	Attribution 2.0 Generic (CC BY 2.0) https://creativecommons.org/licenses/by/2.0/
114, 115	All My Cast Iron https://www.flickr.com/photos/cybrgrl/2272836837/in/photolist-4sQtd2-oBtR6M-8VuiJN-969RNY-6CVPjz-pUHVtw-9DTh-Tz-9DThB2-7HePgB-9DWaCd-pg9bRq-5eh4RH-e3cLGD-qkNitR-cM1WHo-5Kdkgz-ckNG2j-cjUGqq-cfGPGc-4sUY6E-4sQTaK-88Qu76-bTX7ac-e8FULK-cTLuuq-noK6z3-f3VonW-cxsapS-cEfyRE-nMYR6v-nwwEke-bBN3wq-32UAWs-hRaNs5-5GqB8i-djHn8D-du9HMMW-8w2JPV-eUHndi-8UeRD5-6kbBJF-daW8Sx-32UsRf-6ytJ2R-76RJfc-bWrNa2-6khjxb-cxrMG1-6khhQ5-9RR9rh	cybrgrl https://www.flickr.com/photos/cybrgrl/	Attribution 2.0 Generic (CC BY 2.0) https://creativecommons.org/licenses/by/2.0/
117, 118	glass pot with glass lid https://www.flickr.com/photos/13470115@N08/5187648338/in/photolist-8Uq47J-arMbFf-54yLwV-7CBhi7-gKFBfg-abVbkT-aqEs8W-7n3psx-78Rh7E-6vuDmF-e3m2Xm-3mrJcx-gCiWd5-dinKoY-de7jWg-e2L9tU-c7p6th-6EBSkj-5BLBhg-6j5bkL-W892i-6ExDkH-dm7B9a-8HhSNf-94JUra-89mHok-W82at-dm7xzR-W7Zu2-dm7Bxc-mAuJA-dm7Crf-dm7zkd-WbnAS-dm7APa-6XtahB-713HbU-fNRuWn-JGULK-bmUpSY-gKDbZ9-Eums-6BCDsi-7nNsnH-oRw2UC-73H6T4-fNRXpX-gKDyxz-fP8Vsf-gKErVQ	Erik Burton https://www.flickr.com/photos/13470115@N08/	Attribution 2.0 Generic (CC BY 2.0) https://creativecommons.org/licenses/by/2.0/

Page #	Image Title & Link	Author	License Title
120, 121	<p>Le Creuset Stack</p> <p>https://www.flickr.com/photos/dinnerseries/14592249609/in/photolist-GbwM6N-aDENLJ-84w2oY-9656o3-6399Fw-bwK6gH-5Mqz-Wj-634Ugk-pctDuB-634U3r-oVgf57-38REY-6eW3b-5MqA2S-bwK62x-5MmkQ2-oVfY5-5ix9fC-HiHEro-ehcNv3-7qLkC-h-oVfG83-g23qVC-5Mmm4r-83Gpnu-efX4oE-6EMzS3-chAHYS-zSYM1R-oVffui-9ewc4V-5ix9mf-xzuy4Q-zg4w1U-tfaas5-oet6qv-GskdK9-6SgeK5-nhvZu1-vwofra-oE3UfK-onQa5U-oEjAgR-onPPHj-oE3Won-oEjz3i-oChP7C-oE6ZC5-oE6ZFS-zEmMwD</p>	<p>Didriks</p> <p>https://www.flickr.com/photos/dinnerseries/</p>	<p>Attribution 2.0 Generic (CC BY 2.0)</p> <p>https://creativecommons.org/licenses/by/2.0/</p>
123, 124	<p>tupperware</p> <p>https://www.flickr.com/photos/aidanwojtas/13620509065/in/photolist-mKAEPc-4TV6EK-55uEqn-731gwh-kf7SET-prpY64-7vuing-5kvsKf-bsyz6-bsyz5-qT7DF-efnNX-9kU7WF-7AYtpX-4qADX-efnHD-E2hFmd-6DcFMJ-Er68ko-E2hFry-DUVn8M-Ekbd1g-EhXxf-DUVnqR-EtpJsZ-EkbcGv-Er68o9-DvFw2j-Ekbdnt-Er68DQ-DUVmSM-Dw2eTB-E2hGjL-EhXxDJ-E2hG9A-EhXxwE-btBHP9-9VpsFB-6PYFv-6PYFu-qc4gRF-pVaGBw-qbmkPKT-FVerdx-jLa36k-w2DHU-7G6C7f-5VjejF-5VoyRd-3ankiN</p>	<p>Aidan</p> <p>https://www.flickr.com/photos/aidanwojtas/</p>	<p>Attribution 2.0 Generic (CC BY 2.0)</p> <p>https://creativecommons.org/licenses/by/2.0/</p>
126, 127	<p>Enamel Pots - Merino and Possum Wool Shop, Yarck</p> <p>https://www.flickr.com/photos/avlxyz/2865382870/in/photolist-5ncQuW-6DmjVA-6Dhbyz-75BrHS-6kiXTa-9rYaqH-91EE1Z-88xrrz-6Dmk3u-bC2MFJ-bQWsZP-91EDMH-9EgMFN-7rhGkm-6DmkCU-7SyazP-7FJsQY-5gppKt-838kHZ-5BJjS-cQC2Am-bQWsVv-83buLE-ptWavv-9dHvn3-91EDnn-838nwc-6DmkhN-7FLiPQ-7FGpvp-838oxF-CbpFZ-6EdUEV-bFzkSi-bQWta6-83bumb-8bqx5g-8vEXkh-6Ev1MP-6bEf8Y-6mDCHA-91HL9y-7hr13z-amGUhZ-pPD-WJm-91HLrS-7FLiNG-9s2xoq-as1s62-9j6dik</p>	<p>Alpha</p> <p>https://www.flickr.com/photos/avlxyz/</p>	<p>Attribution-ShareAlike 2.0 Generic (CC BY-SA 2.0)</p> <p>https://creativecommons.org/licenses/by-sa/2.0/</p>
128	<p>Poached eggs on toast with bacon and spinach at The Italian Chef in South Yarra</p> <p>https://www.flickr.com/photos/ultrakml/17250196716/</p>	<p>Katherine Lim</p> <p>https://www.flickr.com/photos/ultrakml/</p>	<p>Attribution 2.0 Generic (CC BY 2.0)</p> <p>https://creativecommons.org/licenses/by/2.0/</p>
158, 159	<p>chickens</p> <p>https://www.flickr.com/photos/stevepj2009/3353412159/in/photolist-67k7B2-5KooC2-3emwE-fa8GFi-bMJVLk-kYyfrY-7AMx1-hSXFkR-8Kpzq4-bfnFba-acZEyJ-6Js7gu-MDJyq-bfoPjv-dmBT7n-7VbNCZ-efYK2p-92Q69S-3pN9Gv-7CDey1-61Hx5r-3pSGRq-89PEQC-2wyf-7kzSxn-8G8mdM-dLvtjc-57Sakq-bFwN5a-57MXDK-5UZpbB-57SaJ7-qjJMC-7Vf3fo-iD2u6-mbVPny-8G8maT-8G8mfR-8Gbwsy-a2oweA-96BpwD-bfnFdX-7dsvhn-9B6pa9-cuZJGC-5MqsYg-7B41rt-5aDE7o-9Z6Pxn-dxB6sr</p>	<p>steve p2008</p> <p>https://www.flickr.com/photos/stevepj2009/</p>	<p>Attribution 2.0 Generic (CC BY 2.0)</p> <p>https://creativecommons.org/licenses/by/2.0/</p>
160	<p>Soup Stock 02 01</p> <p>https://www.flickr.com/photos/bradwicklund/7509399702/in/photolist-crAoYG-crA5GE-crA5x9-59Ckht-67m3B-avzbWx-avyBrt-crA5aU-crAp4h-bmKs2P-avAZkC-avzW5M-crzdNq-avCb9s-qQpCVh-crAoqY-avyiKt-aKPRP-8PGQvH-63QKid-crzCUE-avATpJ-crA5ns-avyZm4-avyr4r-9wX-PbN-dkYdg-avyXS4-avBezo-b9D2i2-eEk4W-FYSZB-avB1AA-avyCct-avAXW9-2A7edo-d6XTmJ-6fDtmm-6bP2Cz-5UjZNy-dKn8uf-avB3x1-crA5Sd-5GfMTg-W73U-63LvFg-7JMyvN-9kR7D9-98nLnw-crA5yo</p>	<p>Brad Wicklund</p> <p>https://www.flickr.com/photos/bradwicklund/</p>	<p>Attribution-ShareAlike 2.0 Generic (CC BY-SA 2.0)</p> <p>https://creativecommons.org/licenses/by-sa/2.0/</p>
177, 179, 180	<p>Clagett Farm CSA Week 8</p> <p>https://www.flickr.com/photos/galant/2745810209/in/photolist-5bcZHK-6xYk6K-8fLLdz-6vGsEd-4FkVDn-tc7uk-3GGKuC-8Np3sW-7GeefK-4ACLou-anR191-9xj2kU-4ACL6J-dBm5h-U2xN1-76v6Zw-dfGMxy-LqE7-4AyuU-t-sCkQf-8dBrTS-7G454q-egfuCZ-5wLkAK-gWyVmf-65kvr8-9p53M-5v7A-3CMWia-84mBND-a3eLG-cgtagA-nwrPcz-6NfaBu-4ACKdb-bpHc1R-6vuqv-5geiU-4FkW88-75iPme-LRZuD-nNSEXu-7c4GU6-e4N64B-e4N5YK-83dyMr-4WbPk1-6nKaC-6xWjWN-7XoLdm</p>	<p>thebittenword.com</p> <p>https://www.flickr.com/photos/galant/</p>	<p>Attribution 2.0 Generic (CC BY 2.0)</p> <p>https://creativecommons.org/licenses/by/2.0/</p>

Page #	Image Title & Link	Author	License Title
186, 206	<p>yellow and red onions, at the union square greenmarket</p> <p>https://www.flickr.com/photos/amlamster/6608862125/in/photolist-6H61HF-7PnTju-jaDpqu-b519sH-6moTJW-eMUYhN-cn-9bQ1-9tp7YS-y2aLLY-DrarZM-cDBMJd-ooqkX1-4UqxdF-CZ3Rb1-pgbctd-CtLSMg-eRgi1E-mkd9dZ-CtDYrs-dFScF1-CZ3NFw-9MNjQw-eMHznM-4zkmV-96xoFo-5HPPHA-qkina1-bVAQwV-5F2HLX-8dpagH-CSEwMM-uapZh-5F75AN-8wF9Aj-aQfKTM-CtLUd2-DoRgTd-6HjeVj-5r694X-8ATGfk-6TUC9-8i6rQL-5F729s-iphdFb-GGGzk2-jJMA13-5HPVUS-CtDZg3-afvtkD-5HKxwc</p>	<p>Alexis Lamster</p> <p>https://www.flickr.com/photos/amlamster/</p>	<p>Attribution 2.0 Generic (CC BY 2.0)</p> <p>https://creativecommons.org/licenses/by/2.0/</p>
186, 206	<p>Garlic</p> <p>https://www.flickr.com/photos/crobj/6292444409/in/photolist-aA3quR-8epYY4-5n137K-6NJDv8-2h3CHE-yAC9f-jpaXv-6CTaad-bifJhH-4Gre9A-ZHTr-tU9tx-b1TRmg-nv5smQ-7i7h-VQ-a8YD5P-6HVRT6-9RjwWa-GxdK6-5EVA8-3AHW4-h3qvD5-7mAveZ-6Rss-Dk-8KwLKH-6ckhXg-uogo9-3GX7F-54wEPo-7XDj7-5uETZ6-4Gn5iP-abDRmo-tHa27-fDE71-CZ2HQG-4L7Wjt-DEvMo5-6MczLB-aaWjRa-acwxAQ-cLGG9j-cKuWSS-8KwHZn-c26HwA-wV2LV-nW9hH3-8j2EKn-q5YSv-4Wgmih</p>	<p>Clyde Robinson</p> <p>https://www.flickr.com/photos/crobj/</p>	<p>Attribution 2.0 Generic (CC BY 2.0)</p> <p>https://creativecommons.org/licenses/by/2.0/</p>
186, 206	<p>leeks</p> <p>https://www.flickr.com/photos/calliope/293717280/in/photolist-rXnV3-5o7fxD-5o7f3n-pLYovG-wBfb9-dhrpnk-9svqJM-bm5ZEr-9YZLLL-34Dc-84dUxb-9svqEc-5M6Qws-yJRic-yJRsd-AL2go-6N3uZB-tqzqw-4h5H1Y-tqzqE-tqzPB-tqzqt-yJQzU-AbBBR-4AkEDD-H9AGn-yJR1x-nsw4H6-4dqt2B-6g6oMa-6cXHwJ-5R31G-oRMLtu-aoMWT-hdX1ao-qnEMD8-qDVpTc-qE27Ff-c9LgnY-4fasVG-dRwRL7-e91Wyb-6cXHEN-6fC5j6-922nG3-fv8gY7-tqzqo-GMthX-qwfxDd-6WUPyw</p>	<p>liz west</p> <p>https://www.flickr.com/photos/calliope/</p>	<p>Attribution 2.0 Generic (CC BY 2.0)</p> <p>https://creativecommons.org/licenses/by/2.0/</p>
187, 206	<p>Bok choy</p> <p>https://www.flickr.com/photos/jamonation/5943898575/in/photolist-a4f2XV-dt33nA-bTNKn2-Q1SqS-5enLSL-5einzk-5eioDx-5enLSg-5enKmW-5enLf7-5einkp-5ein7n-5xHNJ5-5NmvS1-tHbsf-tH7sg-aQB3iR-dwVXMB-cdqhiU-6bF6TH-bW3VPa-6JvCyT-4ftBDM-bWHZ1p-aBFyai-6vrbVM-9xj2eQ-63ASB2-4qFrQs-bW3X9v-6rs1AV-dLEx8B-kA47s-dLEyjk-7xDbiZ-cJdasL-5SmYW6-6Nwn8U-9JYMoZ-cdqhrm-8zkhZi-eTJ6mz-b2URgg-pidivX-5jM7a9-pBgvtB-isKJ71-5HZwHv-8UqSnM-dM93rT</p>	<p>jamonation</p> <p>https://www.flickr.com/photos/jamonation/</p>	<p>Attribution 2.0 Generic (CC BY 2.0)</p> <p>https://creativecommons.org/licenses/by/2.0/</p>
187, 206	<p>broccoli</p> <p>https://www.flickr.com/photos/lfi/3605485817/in/photolist-6uB4jz-axgDXo-9m4PyN-eB1MCe-4pQhBN-9qKP7g-5MoxAt-akw9EX-6gm9EC-akyYF3-akyYZ1-qRsFg7-pevHL-9EHBc5-4pLeon-7mwFae-5bUpcX-7BLFNb-aoArme-dngnFt-ahDW58-7HPUgP-7mrjXa-9r3z65-6L8qLe-5bUrFT-qRyEJ2-abZQV5-kGpv1S-a5x4RH-iFU5v-bpoUTJ-7sygw9-6cYDSe-r8WdnN-iFTWyiFU2d-zwicC-96kavP-c3WZU-dnLRdP-6ggXfp-8oAF8d-6xZSBV-qPqUL3-MBk6j-aGjYZ-6vy9Z-9nxqAz-5SwxoR</p>	<p>www.bluewaikiki.com</p> <p>https://www.flickr.com/photos/lfi/</p>	<p>Attribution 2.0 Generic (CC BY 2.0)</p> <p>https://creativecommons.org/licenses/by/2.0/</p>
187, 206	<p>Brussel Sprouts</p> <p>https://www.flickr.com/photos/erindeyoung/6839114945/</p>	<p>Erin DeYoung</p> <p>https://www.flickr.com/photos/erindeyoung/</p>	<p>Attribution 2.0 Generic (CC BY 2.0)</p> <p>https://creativecommons.org/licenses/by/2.0/</p>

Page #	Image Title & Link	Author	License Title
187, 206	<p>SFC_cabbage_green</p> <p>https://www.flickr.com/photos/127921325@N03/15290983565/in/photolist-pidhFF-ctqRDY-7eu92a-5BytG6-5R36F-5BCJdy-682E9R-5BCAoy-5BCxCE-nXDEGc-J5gCXD-8VNPi6-9qDsUF-5BynN8-5BCHtq-brJ69C-nvyUzF-5Byqqv-758avN-7ey3C3-731vJP-nEY8CP-7uFcAc-5R3ap-a2hApZ-b4NJoz-5BCBhY-gBASXc-5BCFR3-8VNWcK-4FFhFB-bb8EjF-bbi89F-7vBmh6-4tK5aB-7QfBpy-aZVxvn-dPtGcl-dHyesq-4kpl7g-5BysPZ-8VNPb8-94vFKy-a1zQGM-DK4Rcu-HTDBB-dHsQee-oiN4Hg-5BymSn-5Bym5c</p>	<p>Simon Huntley</p> <p>https://www.flickr.com/photos/127921325@N03/</p>	<p>Attribution 2.0 Generic (CC BY 2.0)</p> <p>https://creativecommons.org/licenses/by/2.0/</p>
188, 206	<p>Teeming with Cabbage</p> <p>https://www.flickr.com/photos/flossyflotsam/16854221115/in/photolist-rFmhKe-5DbNXp-9YmbAS-dCMk9c-5DbPaZ-6UJAzR-qgayZz-a1sEt3-98jotf-b5aCjZ-765wWf-dCSJ51-dHPiWM-9DaG16-7uG7nu-cXnaTS-e2ssTV-98jko-6CSnZ7-765wS7-e2YvTD-izsSku-8MFxhD-c3bHQN-7uBLCN-9og4EB-64zLz-4DPCvx-dCSnJz-5qW8ad-bDvbBM-7uBM9Y-cXnbsY-kqVxsT-jZpTEM-765x1h-7UvodU-7SclXL-5iUJbD-7AXyqn-8hC2SC-hAJgCj-5x9aW-9k6XJu-pWHemo-dZTaj5-fBiVWJ-7pWdYX-dSdetc-5vMXZT</p>	<p>Laura D'Alessandro</p> <p>https://www.flickr.com/photos/flossyflotsam/</p>	<p>Attribution 2.0 Generic (CC BY 2.0)</p> <p>https://creativecommons.org/licenses/by/2.0/</p>
188, 206	<p>Cauliflower</p> <p>https://www.flickr.com/photos/jeepersmedia/12956171205/in/photolist-kJTLja-4Px3V1-abLHXt-52efNm-62wyqU-DwWosb-eR-3Lan-5EK3YB-8L4tMt-83Skv2-21tR7Q-orP1FE-9Gprwx-5h9yzc-8MakRR-73rVXX-6GaV4d-5hkKp8-6q4ei-rYP4pX-eR3MzZ-5oMXiw-6q4ey-drTKK-c8QoN1-gMFkk-86nc96-wYbB1-qiwQV-7NxMoj-7kGNB7-5EUVSy-8LveBE-4A3GqZ-7dPDNN-avdEe-6EQL55-8VGSZU-pKhpec-7eSyfx-etZ1xN-7XaiTv-6W4hzT-mAJM2-zBxyH-3QJwjs-dDfSXq-3QGb8D-7CrSH2-5R31F</p>	<p>Mike Mozart</p> <p>https://www.flickr.com/photos/jeepersmedia/</p>	<p>Attribution 2.0 Generic (CC BY 2.0)</p> <p>https://creativecommons.org/licenses/by/2.0/</p>
188, 206	<p>Napa Cabbage</p> <p>https://www.flickr.com/photos/jdickert/4876659169/in/photolist-8qW9Sv-hKycC4-9CqjJE-8CyoSu-7B1n19-7zPobV-4aVCjE-dy24H3-5MCLKu-8imLcj-7JVd2X-7ztZpo-dzu7S2-7ZqNv8-rDycB-7ztZqq-7ZqNxe-dKrq9Z-dy7TSb-5E26xr-mGJhV4-pmfVSV-ozjwit-mGLEch-7CwaAR-8iXibG-rdqZ6-azAZSq-dxVzpc-e6bJmX-rbxNgn-jPFCzH-67ghX1-fGBobe-bMTbQk-9ec1bB-hEzVfk-5P3p5Q-931pmr-5L1R4X-e65MVP-6y26nS-7SfaYo-7zT9uQ-4bRxrc-6QSZyR-mGLaPq-a1vSSP-7SbUMg-mGJhaM</p>	<p>ilovebutter</p> <p>https://www.flickr.com/photos/jdickert/</p>	<p>Attribution 2.0 Generic (CC BY 2.0)</p> <p>https://creativecommons.org/licenses/by/2.0/</p>
188, 206	<p>savoy</p> <p>https://www.flickr.com/photos/calliope/14739339290/in/photolist-ossY4u-6NWpFa-7H2G4A-g3VRNK-6FCMeG-cPQjKU-9qDsUF-5BytG6-5ByoKF-5BCHtq-5BymN8-5Byqqv-5BCAoy-5BCxCE-5BCJdy-5BCBhY-pb7rcw-6oXfYs-pNfSEN-Cg9N7j-8RsEL4-78tQMj-7f8Je5-8DzLrS-7eSwUV-5R3ap-5R36F-k9qejn-6fGf1f-5BCFR3-7Mnjyq-5bGunU-5BymSn-5BysPZ-5bGeY1-hEzVfk-5oHEnk-5oHEpp-uDuE6-uDuHE-uDviJ-uDvfh-uDuAi-uDv3N-k9Xa9M-7fa3Va-61T3nf-93Z7So-M5AH-67pmMo</p>	<p>liz west</p> <p>https://www.flickr.com/photos/calliope/</p>	<p>Attribution 2.0 Generic (CC BY 2.0)</p> <p>https://creativecommons.org/licenses/by/2.0/</p>
189, 206	<p>Avacado</p> <p>https://www.flickr.com/photos/ikewinski/6941574831/in/photolist-bzpomF-bmuylj-9ruew2-62w8NL-9rueBc-2fAXZp-e4S82u-arU4hc-6jKz6u-62w8EU-62w8w1-6DUmjK-9MTf5q-T7iwU-33WFEw-agqZ12-4yCJxp-59uL4U-62rTMn-49WDMp-9y7jgs-2MDGxX-8RnEnQ-62w7GS-5SBVuk-62rSHn-nEfpug-59uKUu-7966wP-tNbzTs-8MFV7m-DvZiah-88wHxC-7yyni3-ss9KdZ-q5ZKdA-4JgSgV-5SBWzr-cu8bqj-idDfFN-idDc8q-72r9nv-idDzrz-4Jm633-du4Nfq-dsWqT4-oLJyfp-ixftVz-7Gedz6-BWJ7L</p>	<p>Mike Lewinski</p> <p>https://www.flickr.com/photos/ikewinski/</p>	<p>Attribution 2.0 Generic (CC BY 2.0)</p> <p>https://creativecommons.org/licenses/by/2.0/</p>

Page #	Image Title & Link	Author	License Title
189, 206	<p>SFC_cabbage_green</p> <p>https://www.flickr.com/photos/127921325@N03/15290983565/in/photolist-pidhFF-ctqRDY-7eu92a-5BytG6-5R36F-5BCJdy-682E9R-5BCAoy-5BCxCE-nXDEGc-J5gCXD-8VNPi6-9qDsUF-5BynN8-5BCHtq-brJ69C-nvyUzF-5Byqqv-758avN-7ey3C3-731vJP-nEY8CP-7uFcAc-5R3ap-a2hApZ-b4NJoZ-5BCBhY-gBA5Xc-5BCFR3-8VNWcK-4FFhFB-bb8EJF-bbi89F-7vBmh6-4tK5aB-7QfBpy-aZxvxn-dPtGcl-dHyesq-4kpl7g-5BysPZ-8VNPb8-94vFKy-a1zQGM-DK4Rcu-HTDBB-dHsQee-oiN4Hg-5BymSn-5Bym5c</p>	<p>Simon Huntley</p> <p>https://www.flickr.com/photos/127921325@N03/</p>	<p>Attribution 2.0 Generic (CC BY 2.0)</p> <p>https://creativecommons.org/licenses/by/2.0/</p>
189, 206	<p>peppers</p> <p>https://www.flickr.com/photos/calliope/15150965448/in/photolist-p5QEbd-9xTPbc-8hY64n-6hHJ4-8MteqB-cQjubc-8hK4t8-7ypGN3-7m2gPE-axjuHz-8CKEta-bmynBT-aUjWgg-5xgaYM-46QMFj-amkm5m-8FviwA-9q84yu-euSwem-9q52vn-febkc2-5t3KUE-58Xnoz-dyU2v-qVGcS9-wJvoKd-EvFHih-6ckzL3-8Xg4a6-8Y1sT5-67Ac2-5pdsTN-jFmvQu-M35cT-88iug6-6ckzLb-7XCFfe-3vurfd-5d7S3-6ckzLf-6Cnyi9-7XFW1w-dhw-Kyo-a34K5J-4ALpr6-fDfbiN-gHt32m-5FQf9u-ceR8ed-hrbRSb</p>	<p>liz west</p> <p>https://www.flickr.com/photos/calliope/</p>	<p>Attribution 2.0 Generic (CC BY 2.0)</p> <p>https://creativecommons.org/licenses/by/2.0/</p>
189, 206	<p>Tomato</p> <p>https://www.flickr.com/photos/photon_de/2700323949/in/photolist-57BSet-4yQ7VH-bymSS8-2tN1Vw-9yVqfr-aptT92-7dCKQ6-4Nnms9-ddV7bs-mpcbv-5fg82x-tnyT8-2ouo4R-dSU9sQ-5KdEsA-8EheK6-dh22JR-6LRm6U-dVBXk4-acq9D5-aaRsgT-3nEmE-p6sE7M-ftSVV-5LWsh5-nJc3Qu-drt1Fx-oNaFRx-aqC1dH-drtcnh-omexhf-0j33pB-8arrwS-8JeSZ1-8QJdFp-5oMQrt-4YjwDo-8arsb1-fxE77K-bW27a-q6BgJ-q6Bf-2-6PnSo5-gJYFJD-5qzZGw-dGZL9y-nUdHVq-5dp76g-8JeSj7-8ztV2e</p>	<p>photon_de</p> <p>https://www.flickr.com/photos/photon_de/</p>	<p>Attribution 2.0 Generic (CC BY 2.0)</p> <p>https://creativecommons.org/licenses/by/2.0/</p>
189, 206	<p>dramatic eggplant</p> <p>https://www.flickr.com/photos/eatstayfarm/15351120787/in/photolist-powvok-8bGkbZ-4VoHEN-bjbjy8-bjbjAg-9X9R2W-6D9kch-6Rw9uR-czEAuw-3YKrp-pGYUU1-5oClqs-5SM3y2-5oCKN1-3qHBkS-aDhb1i-cVFPvY-662WU8-2xMLkV-QRkXb-8EHDSX-5oytfx-49NiYf-8xwn23-f8kPtY-8QwWDV-6E3sBE-8QA4Gd-f8ax2Q-8QwTNT-8pPTu1-3nKFEq-5c1k1Y-fgN4N-3YKu4-8QAaco-5oytz4-479tFX-5oytqg-2XvUJw-vQapJ-2EK-XrE-nGVQ95-3YKzE-8SyEnP-4ABkjC-62LF23-5KbEFA-4TNsXm-4Ax42P</p>	<p>Green Mountain Girls Farm</p> <p>https://www.flickr.com/photos/eatstayfarm/</p>	<p>Attribution 2.0 Generic (CC BY 2.0)</p> <p>https://creativecommons.org/licenses/by/2.0/</p>
190, 206	<p>only with vegetable garden</p> <p>https://www.flickr.com/photos/27429206@N02/2740283397/in/photolist-5b9EMt-w8CCD-b33NYB-9McmYE-e5aj1J-5e3m1E-4sPpMz-6zBSRY-fc6ojC-b33Mmr-5c5Yjc-2iHod3-ezhGw-fxz5a-b33Nj2-6LTACA-b33N36-MNFKg-8UGq2V-b33Pxa-b33Qu6-8izoUB-o7wge-92uBJD-9ZsSBg-b33L9x-b33R8M-6HEwjK-ee96wc-6pfxT6-5f9Vks-ee96F2-juRHVh-92xJTw-64rw55-6HeU81-92uBED-92xKio-b33LSD-8izoVn-6HaRcP-b33Lrc-c2mFey-kQqpX-aZ9HHX-o8jAak-f3Nzva-b33PwK-a5MeA2-7Ud7YC</p>	<p>Vladimir Morozov</p> <p>https://www.flickr.com/photos/27429206@N02/</p>	<p>Attribution 2.0 Generic (CC BY 2.0)</p> <p>https://creativecommons.org/licenses/by/2.0/</p>
190, 206	<p>Squashes</p> <p>https://www.flickr.com/photos/ruthanddave/426276934/in/photolist-DEMhj-dcmW4S-8yPcwq-8yPbHE-dfus27-pex4qs-fwpPsz-dfgGUd-dcmVt7-6PiPhr-5rruFM-6JJaA-8NoGQL-6wRSff-2vvfW-e6tSsu-cYHxKu-ay4uez-oWGrP-dhaT9S-e3L1Bf-db5MqE-oJ7kFY-4vTwSo-oJ7kwj-719dyG-cXKT8m-fkReMX-poybJW-9akyB3-8HMTu1-48qirD-dsf9gH-a4i48C-aqYxy5-7hjjpb-e6tS7A-74HbqF-9qCKdm-di2Wvu-dfgHn3-ay4tTK-p4GxhM-sVifs-qLvrz-fscse7-sJKBX-fyfzXu-guzAiu-6Lcq59</p>	<p>Ruth Hartnup</p>	<p>Attribution 2.0 Generic (CC BY 2.0)</p> <p>https://creativecommons.org/licenses/by/2.0/</p>

Page #	Image Title & Link	Author	License Title
190, 206	<p>Winter Squash</p> <p>https://www.flickr.com/photos/summertomato/5234734727/in/photolist-8Yzog2-ygvNj-9gxqm4-dzEHCi-7bRqC6-cXKT8m-hdALX2-drqJ5D-8gBWxd-9mgujm-h1ggVc-ay8D1k-BEVKE6-EJyk3z-qRoSaK-3DDXoa-8gBWvp-8PVqma-8gBWwn-iYMgds-715dfa-6XCwoh-27h7w-8P6fDk-8Kh-dJM-dr2Q94-csXD5m-dr2Qet-g6LKwh-CLGZJr-aQfCCc-3DJjGc-5VB5Xc-Gp-2wDQ-7uHEkn-i1ey53-7K9u2S-6TTVAb-cXKSbw-qF1CWk-7GpWZ6-719buf-EGdzEd-dvkMp4-r6HTn-cXKRGU-5A7YeR-cXKTJ5-cXKSMw-4QBCcK</p>	<p>Darya Pino</p> <p>https://www.flickr.com/photos/summertomato/</p>	<p>Attribution 2.0 Generic (CC BY 2.0)</p> <p>https://creativecommons.org/licenses/by/2.0/</p>
190, 206	<p>summer squash</p> <p>https://www.flickr.com/photos/yukochatulapoly/3700639793/in/photolist-6D1KhN-aaUEmj-vC5xJN-9X4syC-wnArqW-fscse7-gsn6U3-hdALX2-e9z4x6-9gxkVz-6Lcq59-6G5Yfi-8Yzog2-duD4g2-5F2FvM-5HPJN1-8BYsvd-8ArpDn-cpCWns-a4gqfe-5HPUi5-8LcUfx-vC5zf3-x7L1GH-uFN57R-vD1mqg-5F2HK4-5F2E2D-5F6Z8N-5HKpxP-5HPPCF-5F74Ah-5HPKAE-amkSTQ-8rojyH-5HPUj5-5F2Let-8rrrcs-8J7DbP-9gxjNT-tC4qqP-uz83Nk-vD1Gwi-yqPp9m-vC5axJ-vCCBzc-vm4k5y-wrti34-cXkt5b-6F6zUh</p>	<p>watashiwani</p> <p>https://www.flickr.com/photos/yukochatulapoly/</p>	<p>Attribution 2.0 Generic (CC BY 2.0)</p> <p>https://creativecommons.org/licenses/by/2.0/</p>
191, 207	<p>Mushrooms</p> <p>https://www.flickr.com/photos/respres/8497914131/in/photolist-dWW2NT-87bLFN-7WPTAV-2Magb1-f7xikW-nd8Bc-nd92V-2M55mB-ePuset-2M55FK-2MahXJ-e1oyBL-2M5Szd-2M5TnD-oEFarL-2Mahb5-2M5TtT-2MagHq-nv1VJ3-2MagqC-2MagVS-2M5T8V-2M557k-nd9Xd-nd9HN-ndaRu-gGctN7-anHsVj-cMwEGS-8bixVv-rkXZi-gwsVAj-pNjBza-ndaia-9VDkZr-23wAnX-oHVGRZ-fpVHjV-dxe5hT-cG1xtL-cMwHQC-f7i9Lr-3KwMX7-9wCcNp-5t7rqt-8cxRHyt-C8AFNb-rkXZk-a6Wj23-cc2oP9</p>	<p>Jeff Turner</p> <p>https://www.flickr.com/photos/respres/</p>	<p>Attribution 2.0 Generic (CC BY 2.0)</p> <p>https://creativecommons.org/licenses/by/2.0/</p>
192, 207	<p>Leafy Green</p> <p>https://www.flickr.com/photos/rankingfuuta/5501307754/in/photolist-9o8D8G-o7T9ge-4LexJj-8MJFr7-GJffuA-yj2g2S-bzHfUhdRP7np-CviC52-viChzH-Hwqvhh-hfR5H-jkHBo-ptZrc2-6BJwu9-yPT7k-ptuAM-bamE4-7HWTF6-6wXQgP-bNUgvK-bG3EAn-7STeud-dYSMfu-7vBtuV-4xN7YY-ck5tBA-hWtNg-fVVsW2-26eAUg-bLzntF-p2f8YP-hWsXt-ej4JFv-2XWHyR-67b6nD-5J2Xme-4dMplR-7HJhvu-9LGHlx-ehuYwy-8E6YaR-9tbpC5-89hPCG-dYM1Va-6HVvb2-c1Q2h5-c3boFE-hMmNs-ej59N6</p>	<p>Aaron Stidwell</p> <p>https://www.flickr.com/photos/rankingfuuta/</p>	<p>Attribution 2.0 Generic (CC BY 2.0)</p> <p>https://creativecommons.org/licenses/by/2.0/</p>
192, 207	<p>Spinach</p> <p>https://www.flickr.com/photos/notionscapital/10785938473/in/photolist-hr7KJr-886dLB-e3pgfe-b8Hz5g-9ccovD-71G3TD-8DH-PjF-6j3ooG-8DjL5A-7t651i-7gYCwm-6obVj7-nCWTaj-a7GXcJ-6b2GCw-nbuFHZ-8wZpGe-4jaBvb-mH3BtQ-nbuJdZ-SsWap-8k4gbA-8wBAfG-4fjyzh-5sJ7hk-dMywG4-8wBAjm-4j6z2M-nbv2uF-n8vj7-eifS6Y-8wBANu-QLrM-9qGsPK-eXwoha-71G3Ei-avbvsH-6k796x-arwCKN-6obVjf-w3X6Q-bm718h-cnQFYE-c8QmyE-bz1UNT-6ykAAH-9UT2nm-9xjedJ-6ey2Fa-48rCay</p>	<p>Mike Licht</p> <p>https://www.flickr.com/photos/notionscapital/</p>	<p>Attribution 2.0 Generic (CC BY 2.0)</p> <p>https://creativecommons.org/licenses/by/2.0/</p>
193, 207	<p>Peas and beans</p> <p>https://www.flickr.com/photos/mbiddulph/1162209898/in/photolist-2LGCvG-c7Hsus-c7Huoq-9Zq73P-iV6Dih-8aaPHQ-7AjzrR-a6EM8N-b9D6yc-a2i6cE-5F6WzQ-5HPEd7-cF3HrN-6cVvWg-of1E75-5F2DXt-5HKpjD-5bo2Uj-b9Cxn4-cCurfW-6UccNZ-4WNGMR-dFdi85-9QesgP-bzJFay-cpCz61-5F6Xdb-5HPFAW-6J1R4n-bqWN5m-5HPeBq-5F6WCC-5F2Dng-5Hko56-5HKtt2-5F6Zdy-6Gwueg-cwMJfm-4ZHWf7-5gYPKV-dLxzak-5F6WD7-5Hko62-9Q8RBE-cvVvob-aQfdDi-DtnTWL-qMWRBY-cefRnC-6wuBr2</p>	<p>Matt Biddulph</p> <p>https://www.flickr.com/photos/mbiddulph/</p>	<p>Attribution-ShareAlike 2.0 Generic (CC BY-SA 2.0)</p> <p>https://creativecommons.org/licenses/by-sa/2.0/</p>

Page #	Image Title & Link	Author	License Title
193, 207	<p>green snap beans photo taken at Farmers Market</p> <p>https://www.flickr.com/photos/alicehenneman/6120734054/in/photolist-ajSmZu-9Zq73P-dbnif2-5CX1SY-bpHiCn-c7Huoq-6hH-M7Z-5Yw7Zf-dfzseZ-2LGCvG-ehCUdC-dfzs3r-7jvsD4-bU7j5g-8G8gGy-qJr7nA-pwDSY5-kpu37d-8nVfy3-aqNCbw-6LMPKf-6JNnXr-esNApo-6W3dZZ-8BCCBo-zVmKzo-vTsYwk-ahrC8o-asAsQ-hkDg8-926ToM-bpHfaZ-8UXSpk-8nVfNy-4Sn1t5-8jBmit-2QQsi5-cRfE5w-8Cq9YG-8iFYaV-uY5Zag-vD5RYe-7nHEhW-nqGeEo-ct92oN-8emsNp-sSn9E-7AmzNo-6YPrXc-ahFAaB</p>	<p>Alice Henneman</p> <p>https://www.flickr.com/photos/alicehenneman/</p>	<p>Attribution 2.0 Generic (CC BY 2.0)</p> <p>https://creativecommons.org/licenses/by/2.0/</p>
193, 207	<p>Dried Beans</p> <p>https://www.flickr.com/photos/55571726@N05/8143392606/in/photolist-dpB1UN-dHDbz-aFXTJf-dpANts-dpB2C1-dpASK8-dpAP-PB-9raA9q-9r7BSD-bY7Y4s-7vW5Df-cWKXej-7uxP2f-bY7WGH-e7Hfgp-8zzNaK-dpAYH3-6osQBV-9onqdf-gsfGBG-9TDGs1-6RTHtV-ogo9J-odSp46-dpAS74-hho2N6-pt4ifA-dRyT9E-9ktFq4-9sB7tG-Agm5Z-cxRa93-b3KvsB-6Bx45n-Agm3z-9xj8zw-8beQ2H-r1uyAS-D2YJ5-e9ME55-Agm9s-dfQnaY-5A9Sfx-88NZi9-6V91oo-6e3rDy-8vpE4T-8T8ipc-gAiEUS-7xsbY8</p>	<p>dominik18s</p> <p>https://www.flickr.com/photos/55571726@N05/</p>	<p>Attribution 2.0 Generic (CC BY 2.0)</p> <p>https://creativecommons.org/licenses/by/2.0/</p>
193, 207	<p>corn</p> <p>https://www.flickr.com/photos/calliope/5963404319/in/photolist-a5Y1kR-6E3Z9L-8aouQD-2F3dnZ-dkrrFR-73YGqH-dkrrGH-3bXdm5-55kN1S-eU2F2s-6ok4dD-8JaRPE-48MFGr-avvnNd-86BLbV-AgQort-aePgMP-8BGQon-cvbMLh-58UpDf-7rX592-9fj1om-4bRz1b-7iv2A4-6RskHC-aVUzFn-8hdQCB-6xSdfV-5vYhED-fjzNPh-7SPsgy-n21BzZ-9g1wyM-9VoZKN-5iWVAJ-58mCFX-86EX7J-4xkhmd-4Kjqac-bBfl9g-5jmmD-J-ajqGia-afd1Fs-aiapCk-ohYgxM-cw23Qb-8sNhRZ-2ZGY4z-a5XbLK-ohX1pU</p>	<p>liz west</p> <p>https://www.flickr.com/photos/calliope/</p>	<p>Attribution 2.0 Generic (CC BY 2.0)</p> <p>https://creativecommons.org/licenses/by/2.0/</p>
194, 207	<p>beets</p> <p>https://www.flickr.com/photos/29233640@N07/8828255744/in/photolist-es87RW-63KGXb-dCh6wy-6dKe31-8wRz1R-6Lcqde-9X4A7j-EneHQD-4f5arA-fnn8Q7-coCoxo-6dKe3u-i1mDzr-5ZNVhy-3jYCHc-coCVhu-63LTVb-nYtejM-6EX9uC-3mMeTk-coCU7q-5bM6QM-j5Srax-2Ev5cf-a6wEEs-dW9u2-8vdFs5-5bM6NB-9iVWN7-i1mEzT-8wRzvT-4LkMBy-fikSpA-2cFvdu-8wUzAl-jyY7Y-5dvq7N-7Pb13P-8YUffn-FaXtp-94c7SL-9cCmmA-4Lamur-9493F4-ex8Zfv-ohJ8z6-49dNyb-a7fu1q-6U1D7r-9wiPpn</p>	<p>Robert Couse-Baker</p> <p>https://www.flickr.com/photos/29233640@N07/</p>	<p>Attribution 2.0 Generic (CC BY 2.0)</p> <p>https://creativecommons.org/licenses/by/2.0/</p>
194, 207	<p>Carrots</p> <p>https://www.flickr.com/photos/adactio/18845759/in/photolist-2EAbT-4MYigR-5Wo3zi-diQWo3-2aHs2s-kGCMYz-4ss7L-qyXoX-9zdpTU-7Yrhyq-6EQL2u-4TKUwT-6JeoIH-cWC2td-8B3uNR-52Zydh-7Zh8Rz-9nywvT-Usyx-fDbzES-7ZhaxB-cfwDvf-8QnJhd-3QEikr-oukNcm-vAlmH-7Ub8Fk-ofz9HJ-io3V1-rBQRkx-fCskMP-powdbe-fC-smjr-5RjJi3-8Mc8xi-6TD2B-oJgVzj-72QbUt-7xG9rJ-5oSDxi-8HWvj2-2fuPMy-9yR4vu-5PHdTz-oXoziP-fCsmKx-4mAqso-6ZWAgc-8SxEgc-aKhCH</p>	<p>Jeremy Keith</p> <p>https://www.flickr.com/photos/adactio/</p>	<p>Attribution 2.0 Generic (CC BY 2.0)</p> <p>https://creativecommons.org/licenses/by/2.0/</p>
194, 207	<p>Parsnips</p> <p>https://www.flickr.com/photos/pinadd/328054579/in/photolist-uZncr-5vFE-bQ-4nUt88-bEhpUt-b2hXqf-fhRWRt-fi78J7-5NAo57-fHtQTH-fhS7hK-fi74J7-fhRY14-95i9Zp-fi77ps-5k8egE-b1ZgTr-632kDB-fi7jW1-fHLkLC-fi7fiC-t99vN-eZ1CMG-eYPhPX-eZ1K5s-65HsgJ-5t6gbe-5sK3gh-bzzXAE-5Mf5H9-eZ1Luj-636Fms-eZ1CPd-9waX2c-eYPhKP-drTCU-eZ1CtU-5qpSZd-7ipFLW-25RugC-72nCao-8SRvuz-8SUyAQ-8SUzAb-bWq8sN-94xPsr-h1exTk-aE6Qtu-v8Fjb-8HUwqH-9u6SFU</p>	<p>pin add</p> <p>https://www.flickr.com/photos/pinadd/</p>	<p>Attribution-ShareAlike 2.0 Generic (CC BY-SA 2.0)</p> <p>https://creativecommons.org/licenses/by-sa/2.0/</p>

Page #	Image Title & Link	Author	License Title
194, 207	<p>rutabaga</p> <p>https://www.flickr.com/photos/elvissa/368430515/in/photolist-yyiyg-64KxwZ-dw8nde-64KxwV-9zma1y-8Wmqp4-r2ev1X-xnpqq2-jTF5Je-5cbyA7-rZiQ3d-r5Ntwa-rHgW1M-rK1vFU-r5Ntv8-5YWRdA-rK2DaS-oatyYJ-m2s24P-4VHDsu-ysApZc-fjV39u-aNmxxn-fmgoLP-7rJo3y-7qS6Ec-qFvns-a5dB9B-5zEMsg-5pwpvX-eF2DQ9-ioEthr-66o2H3-bv7v1z-bv7vdK-7rfqVk-8VYRJ8-bxjS2B-ieKbn6-bxjSg8-aQgk5n-5pwoZK-5t2rF-9xg2h2-8YCGJW-syACs-eSGqyZ-71cMd2-83sKK9-CQR9f</p>	<p>Tricia</p> <p>https://www.flickr.com/photos/elvissa/</p>	<p>Attribution 2.0 Generic (CC BY 2.0)</p> <p>https://creativecommons.org/licenses/by/2.0/</p>
194, 207	<p>turnips</p> <p>https://www.flickr.com/photos/pauljill/9878497025/in/photolist-g3VT1e-DxLsj9-8FQ5at-9v5eTj-pZjo8F-mpRaxK-8MJJCb-tHDUt-rjQJ7-p872j2-7PEtp7-8MFDwX-4BiWhx-n3G2v8-e8P5vw-7rQKb-bKdPl-7xR7xs-9MsPCK-84v3eH-sFU1Y-84v3ig-MuLFE-oFKs-rjQHJ-baY6kt-7JGe1D-qjTxEb-7JLa7S-flZerw-a9FFuE-c2nbGb-aTww8ue-3Es2nY-5SL4CQ-brnxFU-Xdn3T-85CcMp-ecAKWb-5oMNH-e1J35N-oFGHl-7k729h-7JGfxk-rjQMx-8qXpWp-2LJ4E-6vTQ3d-nVuuKu-eVGmMK</p>	<p>Paul Asman and Jill Lenoble</p> <p>https://www.flickr.com/photos/pauljill/</p>	<p>Attribution 2.0 Generic (CC BY 2.0)</p> <p>https://creativecommons.org/licenses/by/2.0/</p>
195, 207	<p>asparagus</p> <p>https://www.flickr.com/photos/calliope/9492921/in/photolist-QDV4-7ZXMDA-JMnKM-8q4XQ-7mwdTt-KgDSV-8ir6px-8ceReP-4KLbWD-7Rgxuz-4GmjbV-7UyYuT-dXYvuo-7JoGde-vbcJrt-4oxJXE-naizFP-9D5xJP-rU6Xcj-xA2fLz-y3hD-bBKENB-fHgMXW-fHgMVE-9DbtQA-dvnMn-5sbAm9-8c55xu-5bv4kp-bvdpsy-794d5D-4uELup-9Ps5h5-cJ8waQ-7Xwo6q-7Xwo6o-7Xwo6h-51sJye-31FEx-4Lwmrg-8DELWn-nbp1zQ-6jrrXJ-8DQvwZ-28TVp-dxNyu-2aGvNL-7Qspp1-eZ6v9-6tDjZZ</p>	<p>liz west</p> <p>https://www.flickr.com/photos/calliope/</p>	<p>Attribution 2.0 Generic (CC BY 2.0)</p> <p>https://creativecommons.org/licenses/by/2.0/</p>
195, 207	<p>CSA veggies 2/2/10</p> <p>https://www.flickr.com/photos/notahipster/4332347289/in/photolist-7AQpUV-4eUz8A-4fGzw7-8mkcs4-7ssjgh-9RFm7a-bsKw-so-6rw2KL-7FnAUo-8mkcnz-cnJXxU-avFMjJ-9m5D56-8mojt9-8DRJit-8mojxs-96kMwF-k32yT-o4Tpug-8mojqL-6bsEdF-7i6Wwp-6xWif1-GRe6M-AxgUW-kQLQE-6SmbE3-6bwnY8-apon5t-4YvNtZ-gEE6t-pjjPX-cCS2vj-sLaWmr-4CxV8j-apon14-5mP5JR-5MENPC-GkXim-5EHV6g-6UPfK-8sBWLx-aponLUp-dj8ksq-3Th1A-dj8mTR-7xx1F9-VYabL-7twMP5-8XAm6p</p>	<p>Stacy Spensley</p> <p>https://www.flickr.com/photos/notahipster/</p>	<p>Attribution 2.0 Generic (CC BY 2.0)</p> <p>https://creativecommons.org/licenses/by/2.0/</p>
219, 222	<p>Red Potatoes</p> <p>https://www.flickr.com/photos/jeepersmedia/14948091609/in/photolist-oLUSRp-pw5HiY-hoazgK-5YN8tP-bXzZc-6K89nK-59Sy-QX-9UVmvH-rE1Pg-31jd2R-3oC8uc-bpHgfc-8atqmo-a953ms-9vr1q7-eYU88U-a4nbFc-p2nSHN-p4nMNB-oLUVjF-p4pHZi-p2nQWw-oLUTHz-oLUTzt-8h98HK-74gF3x-8JCqPh-cUBdiu-4jpuXH-rYXFru-7JJKZF-6zbGay-9ymbAS-2ip3aG-7G6oDC-ajyqh8-c3pmBs-nE4TGT-fAiDER-2j9Ytp-jCBRz7-6TDsF-7BpdSq-cANcAQ-5zSfdP-jCBRwm-acXcX5-baWFjv-5DzWSP-5QHM3n</p>	<p>Mike Mozart</p> <p>https://www.flickr.com/photos/jeepersmedia/</p>	<p>Attribution 2.0 Generic (CC BY 2.0)</p> <p>https://creativecommons.org/licenses/by/2.0/</p>
219, 222	<p>Russett potato2 web michelleattns</p> <p>https://www.flickr.com/photos/usdagov/8577932050/in/photolist-6gWPFc-6gWPjs-7JJKZF-q3PE3W-cTgoDy-am5Cg4-ouDrGq-9Afw6e-rYK4BM-6C25BN-8UPXet-e519mb-4BixsR-duDjDP-95dZP7-4BixeD-6QCzni-au4xHH-5oJ8DJ-6jLULC-6QEY5q-RHmkB-7sWrks-3BbJyv-sWkvG-4fX1E2-5mflKq-cRTYaE-9kNyB6-sWa1Z-7JL1K-nxz4DC-38N13C-4BnNF1-9kNHVW-9RdsdH-6bJoxB-akZdPX-rwumMy-uYA3SQ-vD7kKp-vCYW7q-uYJmWP-vVZiEB-vThUAs-o6VEt7</p>	<p>U.S. Department of Agriculture</p> <p>https://www.flickr.com/photos/usdagov/</p>	<p>Attribution 2.0 Generic (CC BY 2.0)</p> <p>https://creativecommons.org/licenses/by/2.0/</p>

Page #	Image Title & Link	Author	License Title
219, 222	Sweet Potatoes https://www.flickr.com/photos/jeepersmedia/14763854597/in/photolist-5zf8yy-ouCBBc-7AHV2n-oM7FvF-7AMGu1-71q9Pc-8xS7Ai-4R7Enm-oM5UKY-7SrWgz-oM7FbT-aucukG-bBw344-R59E-bCWM8M-5JtEqc-8WcrZD-5LaFdp-axu1-8XJeq5-ajyqh8-7wJLs4-5w9Qka-7wJLu4-bc8Uev	Mike Mozart https://www.flickr.com/photos/jeepersmedia/	Attribution 2.0 Generic (CC BY 2.0) https://creativecommons.org/licenses/by/2.0/
219, 222	YAM MANIA https://www.flickr.com/photos/cogdog/6729747173/in/photolist-bfHnF-gH932D-GzP7K-cVqhKy-jw3Cp-5DLQgh-5DGzkg-5DLQKU-5DLRjd-5DLSc9-4TAh1j-5Fe1Cj-bffJdB-cVqeub-cVqeMw-5Z8m-SC-cVqf9o-5Z4a8v-5Z8mxf-cVqfom-fJKtfd-BhggL-56C31S-79Vmk8-48V5iR-b6GZCH-79Zbxs-79YWLQ-hR9fz-79YWoG-79Yq35-79Zb63-79Zgzd-79Vogx-79ZamJ-79V5Jc-79V6Zt-79UyNH-79Yqkf-79V3Mc-79Y9E7-79VvRT-79V4qT-79UzFe-79ZdsA-bcrPRR-d9evNW-by8APy-dhoNd-oKL3a3	Alan Levine https://www.flickr.com/photos/cogdog/	Attribution 2.0 Generic (CC BY 2.0) https://creativecommons.org/licenses/by/2.0/
220, 223	Rice https://www.flickr.com/photos/twalmsley/5296951154/in/photolist-955g33-5uwaKr-77ASRb-8hH2KW-2dzhRA-DW9Gj-5RWNP6-8yotoc-dxHMM-4vzHef-6N43J-QtzaD-5mt6za-aEyat-bsWCeP-t9aiK-8FucQQ-dM57UT-3kMa-wEKzm4-5a9q3W-fcN3x9-5a5bkn-e4GHpN-iPx96-5a9nqL-bLYPik-6J8jFz-81fTAp-pAUxCs-eAa2W-5a5a8v-5a9oi3-5a5bsa-6YzQuj-hhyaMb-5a58Uc-4kuxPG-5a9n7Y-dvSu2h-dFA6bc-5a5a1P-5a9obN-xJRIQ-4KqH-5a5bcX-4H9WC5-5a9oVj-aLe41-5a9paE	Tony Walmsley https://www.flickr.com/photos/twalmsley/	Attribution 2.0 Generic (CC BY 2.0) https://creativecommons.org/licenses/by/2.0/
220, 223	Rice https://www.flickr.com/photos/gigijin/138367153/in/photolist-deaJz-71kg2d-dQiF-9H1tBA-jQecJ-jQe8Y-5YxwD8-jQe7w-8QwgQ9-vqJ58-8BrM4s-4Yfh8F-65iwAC-5Xs927-jQeaN-6qwft-955g33-5uwaKr-77ASRb-8hH2KW-2dzhRA-DW9Gj-5RWNP6-8yotoc-dxHMM-4vzHef-6N43J-QtzaD-5mt6za-aEyat-bsWCeP-t9aiK-8FucQQ-dM57UT-3kMa-wEKzm4-5a9q3W-fcN3x9-5a5bkn-e4GHpN-iPx96-5a9nqL-bLYPik-6J8jFz-81fTAp-pAUxCs-eAa2W-5a5a8v-5a9oi3-5a5bsa	gigijin https://www.flickr.com/photos/gigijin/	Attribution 2.0 Generic (CC BY 2.0) https://creativecommons.org/licenses/by/2.0/
220, 223	Basmati Rice https://www.flickr.com/photos/cookbookman/6121427720/in/photolist-ajVVcf-a2bvWn-qTcwCH-9rEHCr-4rrJBC-71EZQ4-4rmEjg-btC1Rf-euwHxh-btC1TY-pyPvob-eurr4K-euyhna-9CXdj5-Bnvtf-6xXEGv-bAvQHv-9H8mbG-9Y3yuj-6nr215-4Cg6RY-cXn8qQ-afkRC5-cXn8GU-qWCv5X-btC1Ko-5eTQYo-6xaeae-ftLNZ2-qPk3u8-73AeH6-cqWtiJ-cbzmU-mhFM8g-7BsNyL-YZ7Ak-dVNeE3-btC1NQ-gX8D88-qEXH34-a4imQx-6xQz8u-FPMtV-zhCJW-7pgtLg-8aphqa-qK7Fa6-7cPX74-pRfxCe-axauEg	cookbookman17 https://www.flickr.com/photos/cookbookman/	Attribution 2.0 Generic (CC BY 2.0) https://creativecommons.org/licenses/by/2.0/
220, 223	Brown Rice https://www.flickr.com/photos/rob-qlid/2889140143/in/photostream/	Rob & Dani https://www.flickr.com/photos/rob-qlid/	Attribution 2.0 Generic (CC BY 2.0) https://creativecommons.org/licenses/by/2.0/
220, 223	rice https://www.flickr.com/photos/dennis/3448059632/in/photolist-6fGd11-92aD3K-5sVuDT-5sZTLb-r9Z3ku-oe8i3v-ocobM1-9PSir6-e1iS9J-h3rpWk-71kgs1-deaJz-71kg2d-dQiF-9H1tBA-jQecJ-jQe8Y-5YxwD8-jQe7w-8QwgQ9-vqJ58-8BrM4s-4Yfh8F-65iwAC-5Xs927-jQeaN-6qwft-955g33-5uwaKr-77ASRb-8hH2KW-2dzhRA-DW9Gj-5RWNP6-8yotoc-dxHMM-4vzHef-6N43J-QtzaD-5mt6za-aEyat-bsWCeP-t9aiK-8FucQQ-dM57UT-3kMa-wEKzm4-5a9q3W-fcN3x9-5a5bkn	Dennis Yang https://www.flickr.com/photos/dennis/	Attribution 2.0 Generic (CC BY 2.0) https://creativecommons.org/licenses/by/2.0/

Page #	Image Title & Link	Author	License Title
242	<p>Organic Olive Oil Salad</p> <p>https://www.flickr.com/photos/aroberts/6944991462/in/photolist-bzGU17-bzGUif-bNBzvg-bzGWHo-bNBCK8-cMzKr9-pK6z6o-m8mga-chZoff-2JxZ3-h4MzY-6n3JGP-4yAoK-dCtmsH-H9VTG-6yhNkc-bPYmRn-58gv3z-qk3Vj-2g5xDk-8gP3sq-cs5XXC-6iKCTz-9N5drP-chr8JY-MNyH-oCf7NG-8ksZSr-8dTckN-jxYua-6qoi2R-4KhUxw-59vZcj-5cWBEh-a5axn7-5KIUXf-7V1mDN-6sefV9-7SpYLq-d2dpAf-6saaxT-44eKq-4-FgLXB-5nd2LA-2zf1Qi-bPYmF2-6iPMpj-9LjEvc-6YDTAh-9jUW1S</p>	<p>Andy Roberts</p> <p>https://www.flickr.com/photos/aroberts/</p>	<p>Attribution 2.0 Generic (CC BY 2.0)</p> <p>https://creativecommons.org/licenses/by/2.0/</p>
244	<p>Lettuce</p> <p>https://www.flickr.com/photos/ruthanddave/4592723444/in/photolist-7ZQUEY-7SUbRf-7ZQUQC-7gfmLX-5Lkf7A-e3U-2Hokv-pM-hy2U-74AFh-a5krQL-8Str2Q-7iff7g-6GCGyc-4P73r8-Sw6YZ-4LwkDB-ftS-Uh-4fwyZ9-dd9D33-7K9thh-73DLv7-25jJE-rPkDA6-6tfbrz-4SYgSp-e5gFM9-66HsQs-6BKV37-8A1qqu-4j877o-6yjqGn-4Rk2ER-6g1XXZ-SqL24-3qcg3Q-c1BjTh-5xpaeV-9HqvLi-7HwAC8-8Sqm2n-9TnMA6-9TqBHF-MgShY-4YQ9af-9CnKgZ-egWNA-5yPtZ5-4iwAR2-4VCVv6-xpC4zq</p>	<p>Ruth Hartnup</p> <p>https://www.flickr.com/photos/ruthanddave/</p>	<p>Attribution 2.0 Generic (CC BY 2.0)</p> <p>https://creativecommons.org/licenses/by/2.0/</p>
244	<p>Lettuce</p> <p>https://www.flickr.com/photos/mshades/2133465570/in/photolist-4fwyZ9-dd9D33-7K9thh-73DLv7-25jJE-rPkDA6-6tfbrz-7ZQUQC-4SYgSp-5yPtZ5-e5gFM9-66HsQs-6BKV37-8A1qqu-4j877o-6yjqGn-4Rk2ER-6g1XXZ-SqL24-nx2sHY-c1BjTh-xpC4zq-MgShY-4YQ9af-9CnKgZ-egWNA-4iwAR2-4VCVv6-3qcg3Q-5xpaeV-9HqvLi-7HwAC8-8Sqm2n-9TnMA6-9TqBHF-4NCMYF-8mowhW-9Bu4NW-7VgMnv-UnUck-e3V-UpaHS-vCF5yE-pVvEG5-HGohJp-9TnMtV-abLHPP-6SKKc9-83Tre-e9USD1</p>	<p>Chris Gladis</p> <p>https://www.flickr.com/photos/mshades/</p>	<p>Attribution 2.0 Generic (CC BY 2.0)</p> <p>https://creativecommons.org/licenses/by/2.0/</p>
244	<p>Homegrown lettuce</p> <p>https://www.flickr.com/photos/dichohecho/2539676022/in/photolist-4SqvC-dTFxbo-6UynBi-orRTYK-89wbBs-8EdxwT-9QM-HmW-8yKkiG-cFUKXE-8z9mJa-7VgLZt-4YEnWm-f9HzDv-7nst6V-jLTVY-6UCqos-2hsUwy-eJrMdt-7s2Rr4-ph8kw-84FLA1-6zA1df-4PbilF-Jf73g-67uHUo-eegPcS-74QHcU-6CKMgd-eJs2YK-6qt1Kq-9UVktD-5jqAM2-4iQULh-5zZKVh-5T8T3n-4Umsrz-oUc4D-a68K3S-9Qn6DJ-9BepJZ-4y8P6s-6tbXHe-8Mdp9g-6ABbrk-8APo1b-bVVBqK-6FKFz-9QMj3Q-cBSrrd-eWU34W</p>	<p>Sarah</p> <p>https://www.flickr.com/photos/dichohecho/</p>	<p>Attribution 2.0 Generic (CC BY 2.0)</p> <p>https://creativecommons.org/licenses/by/2.0/</p>
244	<p>head lettuce - romaine</p> <p>https://www.flickr.com/photos/karenandbrademerson/16781413730/in/photolist-ryV8Du-cCRP1s-6CkidY-aXKDDr-8aTr9N-aio1e1-89aGHU-4v3fQb-ah6HQ1-qTo5GH-wUP6Vj-c2bm8b-82a2Yx-82a2YK-82a2YH-6eZhQu-aNHcNH-a3y7v9-4RuWLS-73yNgw-LLWi4-2C8ybQ-9zKYAb-6CvYD1-bvW8Nd-cUUYPF-8MJL3o-84JVao-c4fmc-c2bkrf-c2bm1b-c2bkhU-HRxs4f-atY9f-04vj4H-7G6oBZ-6xFkyW-2YEyJg-2YEA8g-8uXbFX-5VS6Ut-cQcf9E-5W7MoK-5GNkq-4NKwWT-gN2vYx-atVzov-cV7BNN-6FKgv3-aCM9qW</p>	<p>Karen and Brad Emerson</p> <p>https://www.flickr.com/photos/karenandbrademerson/</p>	<p>Attribution 2.0 Generic (CC BY 2.0)</p> <p>https://creativecommons.org/licenses/by/2.0/</p>
244	<p>endive</p> <p>https://www.flickr.com/photos/jim-lightfoot/11501605044/in/photolist-iwmJtf-ocBx4n-dbekWy-99dSj-bk13LM-6jKJK-99dNZ-dswGc6-3L3bcH-5SVFay-q3G9MQ-7qXgXz-r3zAnp-bFEouH-djbxwi-dCR7qQ-498bwY-Av131-5MgDe4-ffetbU-oVmZBg-a45sTk-8v4Tac-3c2nEA-5bejeo-on7ozw-9vzm2S-6eV9ek-7gBd4a-7oxR8s-6DuEJ2-3c2nt5-64geSY-9Tm6po-cNCWnC-57ZrZL-a3NVW8-eKcdL3-3c2nzj-8hN7JG-5VbVkh-8hJRPi-7Lk3Vt-ojJcpe-ipUtiJ-5A82ax-7LoG17-a3NWA8-64c11x-6dx7ar</p>	<p>Jim Lightfoot</p> <p>https://www.flickr.com/photos/jim-lightfoot/</p>	<p>Attribution 2.0 Generic (CC BY 2.0)</p> <p>https://creativecommons.org/licenses/by/2.0/</p>

Page #	Image Title & Link	Author	License Title
244	<p>Radicchio</p> <p>https://www.flickr.com/photos/summertomato/3773235836/in/photolist-6KqPyh-5hdWN9-8uqS9B-59UiY-9zhGXg-5BQpUd-4sB9k6-bsnP9P-vxjW5W-bsnNbD-6LC71y-4sFcnf-9qH2U5-9og4EB-ortXwv-bsnMbt-88XDwp-ortVqh-4fTxyr-oHWMwU-bsnPTK-4i36T1-4sFcQG-88XDLp-6SAeF4-8HLE8w-6seaNK-6saaxT-quM8x5-Dn1bQz-ddkTot-oTwCfp-891TSf-busaoE-bvBXVw-9xg2g8-4hY128-3mRAR9-bGJky6-bsnLwg-dDpr8Z-5RTEs2-C2Cw-WX-bodHM8-ortVks-dDprtc-dVvYAx-6eZi61-dN3cs9-ortXvi</p>	<p>Darya Pino</p> <p>https://www.flickr.com/photos/summertomato/</p>	<p>Attribution 2.0 Generic (CC BY 2.0)</p> <p>https://creativecommons.org/licenses/by/2.0/</p>
245	<p>Olive Oil Bar</p> <p>https://www.flickr.com/photos/itineranttightwad/3694711551/in/photolist-6Cun2i-ntlQem-6T5wBZ-2TBsrx-ntMdqt-qP1ozG-a1sNcX-8uzYkC-dt9k6j-dt97Rv-sLxr6-4g8VCg-4gcMuE-bNBAkp-bNBzVT-bzGU17-bzGUif-7iGU9j-4gcRoE-4gcUyh-pK6z6o-7nn6Xx-bNBzvg-4gcV6L-4gcSrS-dHH8ui-4gcVbj-4g8NHg-r1rwTG-4gcPPd-bzGWHO-bNBCK8-5WGYQV-hEdRha-a1sMeH-7Dqut8-bMXq1B-7ncF2B-7kKYTR-57DcX-nN3bn8-cMzKr9-897EMJ-5TmyWs-aRHkVz-6PFB3E-3EqLfq-a1vGcG-dGXci3-6yEQYQ</p>	<p>Itinerant Tightwad</p> <p>https://www.flickr.com/photos/itineranttightwad/</p>	<p>Attribution 2.0 Generic (CC BY 2.0)</p> <p>https://creativecommons.org/licenses/by/2.0/</p>
245	<p>nevermind the grime</p> <p>https://www.flickr.com/photos/alamosbasement/3882939571/in/photolist-6V85DZ-6dtHC9-a4tV5Y-hXSTig-k7Qj7-dgMdwq-6dtHu5-wE5H-JBkhz-2eryP2-6dtHs7-6dpzoX-6dtHiq-4z3V8n-a6zxJr-44eKq-6dpz7e-6JXM1r-6du3YE-cdZQ5u-2eH79z-4nxKtr-6dtHnJ-6dpz4c-EuspC-2UFPim-a4rbje-8F6XRY-8CFqwh-hXS7sB-6G3HKV-hXSqRv-kt95n6-hXSgkx-6gxfUk-KLvKN-6tNcsY-4RZkGh-KLwzq-efG5iw-4Yfh8F-hXTDoF-6j3jHB-6donxS-6j7v1y-hXSzPF-363nAB-69Mw9P-csCYQ-6gx5Ze</p>	<p>alamosbasement</p> <p>https://www.flickr.com/photos/alamosbasement/</p>	<p>Attribution 2.0 Generic (CC BY 2.0)</p> <p>https://creativecommons.org/licenses/by/2.0/</p>
245, 260	<p>rolls royce mayonnaise</p> <p>https://www.flickr.com/photos/stone-soup/7534338696/in/photolist-ctMspj-54jhRG-9gD7sy-a8dgQ4-CKFWe-9EHqzi-8yyV2d-bZcHS-dksp6d-dKQ99T-7KfBUr-aANbsd-7uygpG-8kXiW4-7722ZR-74QNLa-6kYkvm-4E6ew4-de2agr-7iBAQx-oDhm87-cXw5A-8i9xWB-9ULg3T-ctMray-6a4f6j-6kYkjd-8GCCSS-ofnbt-dtg4XH-6kYkpl-7hmToP-cy8jlb-eNUwMd-6zf7Aq-6kYjMG-6kYjYm-7CokjY-6kUccV-wk4G-4Fsq6f-qSzfdu-6kYkBY-X45n4-4btz9Y-dBpQSF-cCYfZo-djbAWc-6kUc6Z-cCXvBW</p>	<p>jules</p> <p>https://www.flickr.com/photos/stone-soup/</p>	<p>Attribution 2.0 Generic (CC BY 2.0)</p> <p>https://creativecommons.org/licenses/by/2.0/</p>
245	<p>salad dressing</p> <p>https://www.flickr.com/photos/alexsbayley/11945764724/in/photolist-jcBaEL-mlFg76-84gU74-eV33GD-2wBxw-6gugJq-r4Uq6y-akinE8-p9WpGw-8fSMdj-kQkHwT-89huil-ka9tQx-o4YJKJ-6kw77A-ohuBcx-7KHvYb-oSuWQt-oSvBdG-dcMAcU-oSuWJB-oSvAHd-2QCNY-evWQ1S-oSvAYd-oSvzyu-p9YnHs-5PmvUL-p7YiJS-p7YhAu-oSw6AG-8k9kyk-2wApQ-oSvLLB-8k9kvB-eA9rrz-pa126K-oSutHG-7wN7Na-64FSPs-oStjC-qGCFMh-8ZsrA4-6YGC6b-8dnZjx-oSuDqY-brB3xM-6GvBJY-79aQMv-dcMxPH</p>	<p>Alex "Skud" Bayley</p> <p>https://www.flickr.com/photos/alexsbayley/</p>	<p>Attribution 2.0 Generic (CC BY 2.0)</p> <p>https://creativecommons.org/licenses/by/2.0/</p>
260	<p>Hamburger</p> <p>https://www.flickr.com/photos/kalleboo/454064779/in/photolist-G8cD6-C65xN-8DTk44-C65xM-GpSXC-iSub6f-bKqfk2-84fr7g-kBZ8Av-ceRh1b-3pCvGL-4xkT4v-7TX77T-L2kxk-22Zpd7-qGXyx-dhXDom-iSS6jX-5ZoRPP-ffCLur-5YKSNA-fckfir-5EDGBn-auArsW-8zpu4y-9UW7RQ-3vfrpy-ycNvs-4c6rQP-9uMav1-xRnnp-hUfDnT-4jLNy5-xRn2G-8cCLWG-r788FD-5mGkZN-8Y2gTC-eaP3Hn-Cy1HqX-v56ir-mtBir6-yXny55-cWDCRC-cqci5E-7fMAjr-5kSzMu-ABWak-9AGXkj-xRkYT</p>	<p>Karl Baron</p> <p>https://www.flickr.com/photos/kalleboo/</p>	<p>Attribution 2.0 Generic (CC BY 2.0)</p> <p>https://creativecommons.org/licenses/by/2.0/</p>

Page #	Image Title & Link	Author	License Title
260	<p>Roast Beef Sandwich</p> <p>https://www.flickr.com/photos/epw/5721758195/in/photolist-9HBvnn-ccdB37-98J5f1-q3s44D-KHUEo-c26Zdb-4Hi5bU-a8FM4P-7U1v7N-9hRwrk-jdH2T-4Jqpir-6fp9xR-8Wgjr-87JaY-8JdT7-8ZCp3v-8ByKur-agh7XK-8GDWG8-7mTCie-n2kZP-eSaBv2-9U8Ln2-9Uzb7q-87mQP5-9JCKg-8CTjvA-9fXY67-95z2v4-ptfu73-9FzKRm-bHD9hX-29MQWo-2ztMHF-6naJ5N-dL59cn-9sy2Hr-5TGVUP-8k9kix-7wZybf-hi9us1-d8s9Q1-brdjsi-4osbm9-9sB31j-8be7Ng-bWQ6Xn-2FzmeW-pir5TQ</p>	<p>Pen Waggener</p> <p>https://www.flickr.com/photos/epw/</p>	<p>Attribution 2.0 Generic (CC BY 2.0)</p> <p>https://creativecommons.org/licenses/by/2.0/</p>
260	<p>Sliced Bread</p> <p>https://www.flickr.com/photos/editor/8311347461/in/photolist-dErQ3a-6zKxQR-2s4Q9j-83BPVj-gg85En-bb3f8k-wtimN-6PgvVC-61FyJs-7BnRcW-73bLiX-7YAua-7Tk6BA-dwxQ2q-5bbF49-8uJ39w-ewxSL5-7CAJ1p-6cd3qq-7mCyuA-754FZQ-9oq1St-78r5mc-iJ4ois-7E1AG5-cWL1wq-4sAg9b-ac3peZ-bnUryU-a5xgLY-7QRwBL-5KmcE2-aWPv6e-pCEyv6-6okJyE-7NxEhH-ritPqd-7wc72m-d2fn35-cEsOU-6W6WhL-8Tz2CU-f4MzXU-68V9EJ-b5aADB-8uDrei-6yP72i-j7RGks-bm2yoP-6Q3892</p>	<p>Bart Everson</p> <p>https://www.flickr.com/photos/editor/</p>	<p>Attribution 2.0 Generic (CC BY 2.0)</p> <p>https://creativecommons.org/licenses/by/2.0/</p>
260	<p>Breakfast, round 6 (part 1)</p> <p>https://www.flickr.com/photos/stickwithjosh/5191312802/in/photolist-8UJQr9-eGP83v-3r4yf-7ArfLy-7bbHek-4DmclE-go1hLZ-wMNpn-aqVMNf-8y4S5-a2VuTh-5dm6pR-6U26JT-4HAtQs-bACfxd-6Dbzn-yMaXH-qeg6vB-4QTHg5-8U2pK-fHuD85-vrH9wZ-56FbJo-9CkWP9-eXiMKf-eX7yLx-5CXPq8-HVuv1D-3Bc7R5-7m3qMP-5PKtx6-9C2iTV-7xhg2G-5PfwkN-5k9Fto-bZfDr9-nViC-5vsuVq-9GtsSj-6xKxy7-555dZG-eXiGXs-56HC74-H4YsSk-sv5au5-FXm13j-vfrspt-vn75xp-ui7CRS-vmfse5</p>	<p>Joshua Blount</p> <p>https://www.flickr.com/photos/stickwithjosh/</p>	<p>Attribution 2.0 Generic (CC BY 2.0)</p> <p>https://creativecommons.org/licenses/by/2.0/</p>
260	<p>Sydney Food Blog Review</p> <p>https://www.flickr.com/photos/insatiablenunchies/21458429249/in/photolist-HXWce8-qpiB2h-HvasdX-GfaCp5-u3a4Zc-5Ntm4j-6druGW-6dne8g-5Np5HP-dciP7Z-3oLGHk-caE1oE-6drpBu-dciNBn-6drrPC-6drvKG-39XvSn-sQq3FX-6dnfJg-5VACs4-dciPuz-5knq9n-6drw8Y-6dry6f-6drujd-eeGP27-a5vz9Y-ft8sg-39XwDD-6dnpXX-6drsfU-5Np5DD-pZRvo-8G4Yf9-6dnj8F-6dryVj-6drv4W-6drtTw-6drwyC-BQnxJs-5aPiZj-uX74pp-3KNR84-B6kwGc-wz4u4A-wfwGBi-3KNRqB-pjekJq-CEoKiT-yGd4q6</p>	<p>insatiablenunch</p> <p>https://www.flickr.com/photos/insatiablenunchies/</p>	<p>Attribution 2.0 Generic (CC BY 2.0)</p> <p>https://creativecommons.org/licenses/by/2.0/</p>
260	<p>Mmm... tuna salad sammich</p> <p>https://www.flickr.com/photos/jeffreyww/5958578436/in/photolist-a5xgLY-9Y82uJ-iTt2ni-iTwUNQ-iTv54f-FCevm7-iTxsQW-a3CcDN-8UijZR-7G2y7n-8nLP3i-d3iN3A-pyfdDk-abWTnC-bTLgri-7CDi8Z-4mgAVg-8hg5bb-fqngxc-iTsXBH-byAoS-iTv3j3-iTxsCm-7DYuXC-acdgnh-wacRdN-zrigCr-AvwwXm-zAWgJT-8a2qn1-82r8nf-qjQm25-6kd1KN-4ZQbjp-7o3D92-4me82h-tUECJc-zAMZs1-63iz8Q-buXYyy-8wJ26H-6FPuZ-4YYf5t-4Z3vhN-9xbZVg-a7J83f-a93Dn6-wtimN-5nQuLW-6ScT6W</p>	<p>jeffreyw</p> <p>https://www.flickr.com/photos/jeffreyww/</p>	<p>Attribution 2.0 Generic (CC BY 2.0)</p> <p>https://creativecommons.org/licenses/by/2.0/</p>
260	<p>Smoked Turkey Avocado</p> <p>https://www.flickr.com/photos/dinesarasota/8250325429/in/photolist-dz45ja-7sRAwT-8vEp5t-9hUVnf-nkMLJa-63HELV-fJ8w7w-4mJhDF-5E9cJi-abWTnC-7G1Jz4-sj5F4E-9gKFyT-dVATug-o83cTF-agQmU5-dz45wX-aULGja-dz9yeu-eCzoDD-fkYQAu-bnzsFZ-7ACS9U-5r3DKg-aEFMNC-8A2vr6-9yqYjD-8wLsKY-dz9yry-agMBGa-6uU4Xt-8w8n3L-mGr2jC-arj95W-bsEjNg-oGrZ2M-c7QAHq-8Fw91W-dUpX9E-Y9LF2-dLDwS-dbj48-c4QEZd-T1p23-nFgyG3-fJ8wJG-9JNgyr-8F5WMMH-9SyF4A-aULGai</p>	<p>Larry Hoffman</p> <p>https://www.flickr.com/photos/dinesarasota/</p>	<p>Attribution 2.0 Generic (CC BY 2.0)</p> <p>https://creativecommons.org/licenses/by/2.0/</p>

Page #	Image Title & Link	Author	License Title
260	<p>Flame Grilled</p> <p>https://www.flickr.com/photos/curtiskennington/3626183460/in/photolist-6wr91u-ayuB5H-5vP76m-84BRsq-6CfpRD-9CV8x6-hRKZ-Pe-6Z7pga-6bkQpD-9VvkQqN-9CV8BH-8xKriN-6zDRYJ-cQ6HSh-8GrQyc-4cZSWH-71AdZC-aeBR2E-iTw7Py-7h5XR2-aM7UtV-ccxGHm-6mMsxA-HC-wy2-iTvzGo-88im2r-aeyZkg-f85Loi-6JqLvt-6bkQhv-qjVLgX-9m2kzP-6bpWye-6bpWqA-cV1uu-seEML-9CV8yk-o1vkYD-FbB5yJ-aCNtd1-88kt2c-eie76W-8hN6ij-5EcFtq-24SXCy-4JqPdV-5Z7bGW-5Ard1Q-5sKiPX-fen7Tj</p>	<p>curtis.kennington</p> <p>https://www.flickr.com/photos/curtiskennington/</p>	<p>Attribution 2.0 Generic (CC BY 2.0)</p> <p>https://creativecommons.org/licenses/by/2.0/</p>
264, 266, 267	Salad Dressings 101	Chef Nathan Hyam	
274	<p>Fresh Seafoods</p> <p>https://www.flickr.com/photos/kinosaktionsen/21719867430/in/photolist-z6iZSW-fPMtWS-8SEt5h-iaAVaE-5tLzPv-iaB7Jh-p9aBAE-6Qr13g-jw4qdA-4nAp14-9vsdU7-oGKqf-4zCUYz-77SwC5-hSQVj-5tLzpp-6oEFjb-naQVsa-iEdM43-hvHyt-bDteh6-cdoDx-2LmaKK-5CGc3G-2XBX5C-pt3F13-99enb8-8kdFSA-cziwm-bBkZfu-8kdFAG-3f4LRe-gHQvTG-mUv2iW-6RRhtkv-gHQpx4-7TType-447J7V-7AHiz5-j9GGZ-N4nro-sDUSV-5zmkCY-oPp2z-7FBsPR-2XBXLG-ojAbC8-2XChRd-4mPmUQ</p>	<p>Nishimuraya Kinosaki Onsen</p> <p>https://www.flickr.com/photos/kinosaktionsen/</p>	<p>Attribution 2.0 Generic (CC BY 2.0)</p> <p>https://creativecommons.org/licenses/by/2.0/</p>
280, 281	<p>fish3433</p> <p>https://www.flickr.com/photos/naaaphotolib/9861860523/in/photolist-g2sBxZ-2yt1sy-8kwy5z-iopeoy-b7obZF-fqREX8-p3wet8-2yssiU-fXRXXW-8kzKu9-hyT1gW-67hH5h-8kzKkm-Vn3CL-bZh44s-8kzM-dA-8kzN91-8kwAaB-6giHhB-efpHwp-8kzMG5-8kzKGy-99XZCF-8kzKnf-bvreWs-8kwB9X-8mxzUT-p5g6bX-8kwycA-8kzGWQ-8kwzcP-8kzNBE-8kzJDq-8kzJ6h-8kzH1Q-ifRWM-2ytuf5-2yoMnF-9Zp8TG-fXR9Zt-cJPCWN-6AAwwS-2yoron-8LbPff-bti2dE-93sGXt-autrZL-7seGdk-6AAys1-9unGp6</p>	<p>NOAA Photo Library</p> <p>https://www.flickr.com/photos/naaaphotolib/</p>	<p>Attribution 2.0 Generic (CC BY 2.0)</p> <p>https://creativecommons.org/licenses/by/2.0/</p>
284, 285, 287, 290	<p>Trout</p> <p>https://www.flickr.com/photos/03marine/8470408081/in/photolist-dUv4dD-oCBK6n-p9ajN7-oEVj6Y-8aa8Nb-9pXxeB-2bBgB2-iyR5GJ-87pvy5-dbey8D-87miXX-7ybXua-8Me1sC-cq592Q-nPCQgL-2rwd6t-fNpteL-6DCiaj-8JdKaW-91AYp8-abf2uy-9xvSMq-eKvEft-n3vYP-wRvBkC-8dfGoV-fN7TC8-mFTLZB-5FjQuu-4o53nD-giwKoz-8JdKJh-a2Bh83-8JaB4p-d2mjfW-abf2t3-6miokE-7FUFeB-6VxmB6-8JdEFs-34jRtn-8JdKqC-cQt451-7vcrfm-bzWpkC-wRGScN-eFc7G-6TxdXF-79EwxT-9BGjNw</p>	<p>03Marine</p> <p>https://www.flickr.com/photos/03marine/</p>	<p>Attribution 2.0 Generic (CC BY 2.0)</p> <p>https://creativecommons.org/licenses/by/2.0/</p>
287	<p>Sea bass</p> <p>https://www.flickr.com/photos/hazzat/3337586255/in/photolist-65W17B-haYZv-6ivET1-bq8K2-8Usmdq-6CLdzC-6gG1YN-hRLLF6-2x7yB3-pJV6tK-bnq7cZ-8Usd4m-8Usmf3-6feHVC-8G96EF-8z9sDY-4A56cT-8UsoYC-7nNnid-4NJtj-7AnZau-pJUSkv-i9Pa2L-fddtox-dFKvrj-8UsoZQ-psKmwL-dxvohd-6noH4A-bqb9Nn-dxpWhg-8Vdjsh-5jAuUs-bqb9QK-bQ8imt-3nJoJT-6fshZu-aRMC44-HWkwYf-mGBpwK-4ve3zp-a4vMFj-dxpY6X-dxpWBK-cJN8JE-AJdAc-5wzABV-8J9ag-a98iaR-7QoAr6</p>	<p>Hazzat</p> <p>https://www.flickr.com/photos/hazzat/</p>	<p>Attribution 2.0 Generic (CC BY 2.0)</p> <p>https://creativecommons.org/licenses/by/2.0/</p>

Page #	Image Title & Link	Author	License Title
287	Catfish https://www.flickr.com/photos/ratha/14402233036/in/photolist-nWfD7G-4Fb5e5-8dnddL-c7a7k7-6o6UMR-4zDbco-azCfcp-7SMnxk-8dnhY-7gLNW5-2hUmev-cFF2G5-KWmnQ-7NmFJs-8WCseQ-8WCrbL-4F6P7D-KWkwU-9GnKZW-V3Gk-KWC5k-6o9MuG-9XhV-b3ynwF-6qcCjX-3b2r31-4NYHoE-5dKkLS-6WfW6-daPDcK-ATaYq-9LzZ52-9LzYXK-eisWLR-6WEGh-7REdAu-r7KWr-7Rioq5-3c777-9cmBuJ-e56Fb1-Rg-WsY-3edFZ-4H93Wq-6t5QUH-9TKyx6-7Kvu4t-nmbhar-63pYjA-fe8viv	Ratha Grimes https://www.flickr.com/photos/ratha/	Attribution 2.0 Generic (CC BY 2.0) https://creativecommons.org/licenses/by/2.0/
287	Large male arctic char https://www.flickr.com/photos/nilsrinaldi/3423100627/in/photolist-brgkk9-7nkLJU-6duhyk-8Rrucv-54c41G-oEgWF5-5dWYDQ-dKTMXs	Nils Rinaldi https://www.flickr.com/photos/nilsrinaldi/	Attribution 2.0 Generic (CC BY 2.0) https://creativecommons.org/licenses/by/2.0/
288	Cod https://www.flickr.com/photos/cocayhi/5473418510/in/photolist-9kEGCE-ePv8vs-6U82Xh-6PUGBW-572qnA-572sNG-ampViB-572ruG-m3PU4-ePv8JE-7hD3M1-nrFyx-6U83Su-6U41LF-9VUGs2-523vvg-77pDio-56Xeo6-boaSJ3-fHpBs3-fHpjYU-dnFBD3-9ARcUz-9ARcHk-5cmwB8-DFnUVG-fH7vUP-9AU76j-49C2Mu-dNa8cp-haCnD-9AU6tw-fHpzpU-8H1mQN-9AU6eY-9ARcZg-572p9f-4cEi9D-6U83Ys-4cPZtC-bBDMvS-8z8jgA-a5Vpo5-im71e-h9vFSC-4cL3g4-4TU5sg-4cL3Pp-goMqC-7F6Crw	Adrian Mohedano https://www.flickr.com/photos/cocayhi/	Attribution 2.0 Generic (CC BY 2.0) https://creativecommons.org/licenses/by/2.0/
288	Pacific_cod_-_cropped https://www.flickr.com/photos/30540563@N08/12835232793/in/photolist-kycVx8-6a4f6j-7E1AG5-55reQQ-7XTCYm-9t8w6A-8eWt4z-69Z5mg-7E1AD7-69Z5Ci-69Z59Z-69Z5dx-69Z5hK-69Z5qg-7gQoga-5ru3FH-88jMW-oyyR1h-5EEzjE-6Qxue-oSgHvP-oBXDHe-ebWYT6-6n8Qni-7GoU8D-69Z5yM-7DWLze-8gsXPL-6arSnV-oksPS1-6WERM7-oShNDS-7pUrgq-oAwLBD-6aw3f5-6aw2Xb-owKaoJ-oyJ5YW-ohhijV-ohgXws-oyK8qj-ohhkSt-6WARBi-ohhuGJ-wtT5N-7pUqYb-69Z54r-6WARmx-oBVUN5-oyyXU7	GrrlScientist https://www.flickr.com/photos/30540563@N08/	Attribution 2.0 Generic (CC BY 2.0) https://creativecommons.org/licenses/by/2.0/
288	GulfWild Red Snapper https://www.flickr.com/photos/newamsterdammarket/10672804994/in/photolist-hg7V6d-PJvY6-e7x1A-6ezJ78-6DFEqq-47bbyt-9dB5M-ozuKbb-fRRkbL-9Mx6Vg-6DFfmb-pCRXTB-54iVYq-eZEcTG-ir97xT-8KpCwi-nJwg63-6MgA6-eXzZX-7HHfVB-7xBAJu-bDnLsn-62b4Pm-dkCn6Q-bmQ3sy-dA1FYm-qFAwpy-i2nYBj-73rMDa-5W7uPu-s974r2-geYWj-5BXMhT-8uVsMZ-pJKMLk-pnRiyC-ezKRGg-8wtY1G-5C32ej-fo7iDu-amXZgQ-6Uwqcn-8hcxNR-7JtWy-8KsGiu-PJNVU-p3zyzh-rM1Aq7-qGqwzA-7x87LH	New Amsterdam Market https://www.flickr.com/photos/newamsterdammarket/	Attribution 2.0 Generic (CC BY 2.0) https://creativecommons.org/licenses/by/2.0/
288	Atlantic Salmon Pre-Smolt https://www.flickr.com/photos/usfwsnortheast/5197994241/in/photolist-8Vk5An-ahrQyq-8Vo8WA-pok52ds-8Vo91J-euuWXH-crxtPS-9Emqk1-8e5boY-8HErgR-8e1Y1t-pCCXJ9-fkrZfw-8e1YgD-e2eeVe-al6BG4-8FjMH5-8e5btG-fiunxF-4WWjGT-8vc24v-epnypM-9Eiv48-oHVX78-cDuch3-8VK5P8-8A7DQ8-dLcaPC-8Vo8RC-8XTwFJ-f3TgZ-62S2g-fGfsJy-qbV-puD-9EiveZ-6iggdz-ejsUx3-8e1ZAr-inxi6x-masWd-pUxyiu-pUwxvC-5pAkX8-dG5z5P-fkrZzC-dwYpLM-bq2QW7-aDzfAK-9ARcUz-9ppCQM	U.S. Fish and Wildlife Service Northeast Region https://www.flickr.com/photos/usfwsnortheast/	Attribution 2.0 Generic (CC BY 2.0) https://creativecommons.org/licenses/by/2.0/

Page #	Image Title & Link	Author	License Title
289	chinook salmon caught in the Haast river https://www.flickr.com/photos/uncle_sam/5723084712/in/photolist-9HJiGm-oSP1QM-BL3K66-qTr7cT-oJSFVX-CPNPLd-6m5eWa-c9Aw33-pFFhnt-6uPpHJ-yn2Rdu-q7SS39-ejNjly-5gNuKY-p8hcJQ-qRiatL-p8hbb9-oSPY6K-pahskh-p8hggj-oSPYnr-qBaQLR-8FSbhs-pa3Nen-qTr688-ueHz2W-oSPXVA-oSPPubu-oSPuXQ-oSQ7cq-qKXc1N-pajgaR-r5eEbm-DD44wX-pajpGa-iE4eqn-oSPY7C-pahgUh-oSQAaBw-pa3K9p-p8hdV7-oS-P3uD-uwxauM-deE61M-pa3AhX-pa3A4F-qGdHEy-pa3zu4-oSNTB8-oSNXJP	unkle_sam https://www.flickr.com/photos/uncle_sam/	Attribution 2.0 Generic (CC BY 2.0) https://creativecommons.org/licenses/by/2.0/
289	Coho Spawning on the Salmon River https://www.flickr.com/photos/blmoregon/16335495542/	Bureau of Land Management Oregon and Washington https://www.flickr.com/photos/blmoregon/	Attribution 2.0 Generic (CC BY 2.0) https://creativecommons.org/licenses/by/2.0/
289	Tilapia Roja https://www.flickr.com/photos/lunasinestrellas/16648608271/in/photolist-rmbtdc-bjflpv-CUAWn-7KGLQD-9GUeFK-JcSs8-7KehSZ-bEP6Ht-9p1kLJ-3rgkXW-3wDjTP-fEgat4-xTmMV-9DpEJ6-o6YxTB-fExLBC-fEg-bZR-qPAWs-5hc28R-bPtcxZ-f7jdZ-pMRPxB-4j35mc-4j36qv-8Wwcpf-8Ws8XH-4j77md-8Wverj-8Ws8kH-8Wveuh-8WvbHS-8Ws9WR-4j34Ae-8Wv-bY7-c1nwtj-8Ws6UT-8Wvdom-8WvbQN-sAYXR9-8Ws72z-8Ws7iz-f7fCah-8WsabV-8Wvc73-8WvdCs-8Wsa2H-rgnavf-kQmDGB-GRaCHC	Luna sin estrellas https://www.flickr.com/photos/lunasinestrellas/	Attribution 2.0 Generic (CC BY 2.0) https://creativecommons.org/licenses/by/2.0/
290	JALX12TFX01-6061 https://www.flickr.com/photos/theanimalday/7142820373/in/photolist-bTbPDP-bTc4pn-bEcQjw-bT6xcn-bTbNBM-bT9s7P-3bsjoJ-bei2Ru-bTabbH-bEgWgS-bT9T2t-bTbJWK-bT9xvp-bEck1C-bTc5v2-bTbM-mM-bT6VBk-bEfamm-bEeLtw-bEcpKY-bT7aEH-bEcxB9-bEeJLQ-bEbr2q-bTaxav-bTaEs4-bTc392-bT6JH6-bT7dqT-poUk2q-bEfV4G-bEhfoh-bTafJa-bTc-5We-bTbXse-poRVGK-bEfcEW-m5ojVH-bnKT4D-9CY4wW-8ADdCM-uhtKKK-aoDDLZ-6bpBbg-jyKb9k-owhaRd-9CV8BH-aKsb7H-4XJaQ6-e4sQWd	TheAnimalDay.org https://www.flickr.com/photos/theanimalday/	Attribution 2.0 Generic (CC BY 2.0) https://creativecommons.org/licenses/by/2.0/
291	Flatfish https://www.flickr.com/photos/ratha/20808905526/in/photolist-xGP5Dd-5oPgZH-7UU5Rf-7GRN2B-omn8tu-8Pppen-5Ay4wz-5ACiX7-5h4rbq-6wtYpS-GFGxB-2upE6n-6CJo7Z-5arkpc-2up-zne-2uu1B3-rva6x8-49fVvY-5XMnnD-njZ76t-4iDYAH-aLYU4K-qkbgkp-hnTZ-Ba-amhpvi-8PhQaz-ho9jeK-4spGZp-PEG2J-aC1UuD-aFnSjY-8kaQts-eojeKF-7jguW7-7PiQ1S-7jgujy-pJiFn-8Mg6gh-7zmpu2-drwzjo-6xNw6F-doGFK-sAHD7-aLnnCz-87ezCp-9nxdyZ-5MZYb-9qthmb-azw2rF-4ZDeVS	Ratha Grimes https://www.flickr.com/photos/ratha/	Attribution 2.0 Generic (CC BY 2.0) https://creativecommons.org/licenses/by/2.0/
291	Flounder 083 https://www.flickr.com/photos/88158121@N00/4526765858/in/photolist-7U1RmD-bk1D1V-4ujHAA-fnKmwR-8Z1DQf-bYzhJq-4xuCJo-rd4a5d-gguw2J-6i6wm3-pHwkKP-67Pqrm-g8ceTd-8fFagJ-6xie1M-7DrqPT-7c7ut9-mpjwLE-e73dHn-9cGU46-sgqTN-9xUaZ9-4sDuBD-qnuSVU-pHhBST-qnuDN9-pH4qo7-o2vo2W-pHhJFZ-qnuzrd-SuaXZ-7usvug-ofqHFJ-eMFEF-SuaZt-aeJ399-4bnHdx-nNCGzF-fppw72-9nxdyZ-kMBeQP-fs22qq-eygkD-9qMdFs-9qMcGy-wRtnPe-8ToHj6-8YXJiF-h8imSd-k2Npmo	Louisiana Sea Grant College Program Louisiana State University https://www.flickr.com/photos/88158121@N00/	Attribution 2.0 Generic (CC BY 2.0) https://creativecommons.org/licenses/by/2.0/

Page #	Image Title & Link	Author	License Title
291	Sole https://www.flickr.com/photos/9084427@N07/4026631050/in/photolist-78Px8h-o4kvS-iudENr-o8snC2-etKgAd-9jC2Ln-7RCbAL-5oEL-hb-5oAtZt-a9FCWR-7CRAAr-cYuHE9-8Zo9vs-cYuPqu-496Np1-cYu-Myq-5BpgrP-cYuKBF-nNUFNg-nPbnUj-o8u8gH-9cGU46-jJ8JaK-6oN5Qj-iudYyj-2DkLFN-8kAQts-aLYU4K-a21bpR-8z26pL-8TTiw-a5FNGB-nDuvKF-nDuu6Z-77qmhf-7xkr2Y-4qWcqz-5AXD4-a3ZNVf-8NtRb7-8UpgB8-6dsegE-adEdW7-5Bir4s-gkJyxR-5Ng4cX-5ofoBQ-5oaQTP-5ofRKB-5ofu9U	Yellow.Cat https://www.flickr.com/photos/9084427@N07/	Attribution 2.0 Generic (CC BY 2.0) https://creativecommons.org/licenses/by/2.0/
291	n89_w1150 https://www.flickr.com/photos/biodivlibrary/26969786285/in/photolist-dprPNA-dprDZg-dS6BQY-9MdkBB-9cecvz-dS6BWW-yZ7z-PE-9XSrdN-y5oQTb-yJUE7P-yJUDLD-z2q96X-sddwkC-y9J8Au-yb9qKb-pz4qnf-dprDji-dprAZK-53Dfgy-a6v5KS-dprLXm-8JHik2-6daMS2-6UmeA7-9hrX6g-4sLY7P-b9TaHM-4r6z6-fy3fFP-nGY48C-wW2LNC-7x1D3m-3CAAD8-iNhXw-bgGmcc-pJyA1D-993yuy-aUP3wp-dps8Uj-4xuEK3-dprNnW-2Pbfah-5tkhvw-6oH6qB-5YFWYQ-aGJnaP-dprF5a-5Ns5Xf-66xJSf-H6ecRg	Biodiversity Heritage Library https://www.flickr.com/photos/biodivlibrary/	Attribution 2.0 Generic (CC BY 2.0) https://creativecommons.org/licenses/by/2.0/
292	Halibut https://www.flickr.com/photos/hutman/3473211725/in/photolist-6hV7QM-6RKdk3-4R6voF-fcqzxA-fcoPR7-fcoBXf-9C5kt-fZSwpC-8XgkBM-fcbbpa-fcb-gYc-fc9rwD-5xifF3-fBmsU7-58G1M7-fcqxCQ-4RaJBo-fc19mQ-5xiftC-fc9dUn-fc1aLJ-fc9yZz-fcqW4f-fcqy1C-evWH3D-fcqWNY-eav9xD-fcbasa-fcbcuT-fc9h-We-fc9fee-fc9Jt-fcbdak-fcqWvm-9C5kS-9C5jJ-fcoAob-9C5jA-aEQiH-fcqAPf-6BAo2c-4gLMj4-fc9g1t-28zif-6u7QDH-fcbhyV-5xifvY-58G3Ju-58BSLM-5fejzn	hutfour4 https://www.flickr.com/photos/hutman/	Attribution 2.0 Generic (CC BY 2.0) https://creativecommons.org/licenses/by/2.0/
292	Turbots https://www.flickr.com/photos/jeancaron/4948060385/in/photolist-8xf6XX-Ag4xCS-AnUf4a-ajfvd9-6sfg6c-8xi7Qj-eiXqgB-a6yHGS-jEKy5-deHZW6-qzapAf-pEF7mk-9Sxfv8-qjSRju-qza7CC-aLYU4K-Ck5Fmu-pcHQZ2-cZDx9s-o5qcy1-cZDxgU-qBgAxx-cZDxkq-cZDx79-cZDxf3-cZDxhY-cZDx3G-cZDxrQ-cZDxwG-cZDxus-cZDxMs-9KVDsZ-cZDxGo-cZDxHb-cZDxx5-cZDxSC-cZDxHw-5ULdLe-cZDxTy-5yPzoW-dBBGZP-32yAyn-fkPVzp-32yB3a-aLnnCz-32yANK-eaeBmW-zAvavR-8VKHSd-ahgZTb	Jean Caron https://www.flickr.com/photos/jeancaron/	Attribution 2.0 Generic (CC BY 2.0) https://creativecommons.org/licenses/by/2.0/
293	molluscs https://www.flickr.com/photos/49873808@N00/3611508064/in/photolist-6v8Vwq-f3nCSR-4gnVWc-m7UTE-5o8f-e6SoyN-4zQsbn-r8nea9-raUxC7-6hC4Bq-9RtiWL-dQJBZn-7AKDhc-RjKqP-qCDUM1-33kbHi-33m8hZ-7aHuT5-f8gPAR-7yrjnY-5o8a-f25wCp-7aztLV-en5jWU-rTndh7-t5LKcd-49WUcc-cMBtA-dq6t3-f2jFpd-f3BPQL-24CDkS-aoGBFT-f2m7fy-f5e2Uy-dqa9R-f2jTF9-7s3fxf-f2jWLB-6jq7hr-4g8qqT-6uavoo-f2jDKo-9xh5NP-6uavkS-6u6miF-4grZTJ-7hm55q-f2jHdU-81UsXz	Matteo X https://www.flickr.com/photos/49873808@N00/	Attribution 2.0 Generic (CC BY 2.0) https://creativecommons.org/licenses/by/2.0/
293	Abalone https://www.flickr.com/photos/bfishadow/5700312396/in/photolist-9FHAhd-ra4Y5M-ahwfgg-ahw9yT-6ZYcVL-asHzLf-EZLFNA-cBzbQd-6ZydcE-5EyR9b-ahwbzZ-oUi89a-ahyWuW-6ZYdGE-4mUxaH-KCZ7K-7hSsYZ-7AzjgY-5o9joT-6ZUdYx-ahwf66-ahz1p9-6eKnaS-dtjFn1-9rhx-Vm-c5MbiW-n1cDDm-5rHBhB-arBSff-ahyUgN-7Wos2A-7beQXH-7WovTw-7beRga-orHZnf-7WowLE-eecPHF-7Wot5h-bEf8w-7WkbzH-SiZWEF-ekPtGX-48VVGx-c7nHF5-snaBmG-48ZXUm-q73LB-3nYizn-9FPHU-ahyUc1	bfishadow https://www.flickr.com/photos/bfishadow/	Attribution 2.0 Generic (CC BY 2.0) https://creativecommons.org/licenses/by/2.0/

Page #	Image Title & Link	Author	License Title
293	Clams https://www.flickr.com/photos/bfishadow/5699749861/in/photolist-9FEH4k-4H9pY6-4T2Eje-ay7ZrB-8CmBno-6Zv7bj-bozzJ6-bdeGjK-62vdfw-a6STLr-a6ST6v-6korov-7im5rP-bdeF6R-bdeHnt-a86g5B-6qhzTq-pSUcuw-77Sw7C-a6VLV5-a6VK4h-aena8f-785Lq1-6koq8X-8g6Rp7-7xWRNF-bdeKke-7U1StG-ryMM5f-aAaYtD-bdeMX8-4ZPq5Z-71nU8G-4F5i1t-cRcfxU-7PsRwA-4Ux6Yx-ND6ef-6DsPw8-fsZzPr-8Wd6Qn-8qQsQb-cN2UEj-7U2ySd-7U2yJU-7U2yWm-4Ux6wv-FhjJ5b-8v3LJJ-hL9g3U	bfishadow https://www.flickr.com/photos/bfishadow/	Attribution 2.0 Generic (CC BY 2.0) https://creativecommons.org/licenses/by/2.0/
294	waiting for linguine https://www.flickr.com/photos/lecatess/3486181734/in/photolist-6j4AnC-4uvqGn-8Bsey9-MS71k-ovvDnz-eWbxKF-6KxesH-edLTaw-7CJ1iZ-7CMNoG-GlkcV5-pvFxcn-HD4utU-HD4u2m-HD4v8Q-Glkr9-HG13Xa-GMRD4z-7CMPHo-4zg8E1-7CMNz9-7CMN7W-7CJ16R-7CMPnh-DbACU8-7CMMiY-7CMPKJ-5ZVTS2-7CHYgi-7CMMey-jqNVb-4uvspc-7CHZfx-7CHY4x-7CHYd6-HG1ozr-HG1kgx-GLpxZe-HD4tzu-HG1p78-HzLda8-9n2j8D-GlpwY6-HG11B8-HG156H-HzLCqx-HzLBJH-HzLF9t-7CMNMj-7CHXv2	lecatess https://www.flickr.com/photos/lecatess/	Attribution 2.0 Generic (CC BY 2.0) https://creativecommons.org/licenses/by/2.0/
294	Cherrystone Clams https://www.flickr.com/photos/naotakem/4015896488/in/photolist-4H9pY6-nKdNgr-77Sw7C-9DN4e1-7PQSCU-d4j41A-a8u4Mn-7YRy9J-6nzYzA-6nvSpx-6nzZvJ-nKdMXF-o2Hn4e-o2HmGT-b4aLUB-7WJP72-nKe-MV2-6nw8z2-a8u29v-a8wUEu-6nA1MQ-a8wTAm-7WMEBu	Naotake Murayama https://www.flickr.com/photos/naotakem/	Attribution 2.0 Generic (CC BY 2.0) https://creativecommons.org/licenses/by/2.0/
294	Stuffed Clams https://www.flickr.com/photos/chasingbutterflies/2791416025/in/photolist-7ZmQd5-5KxmF1-5Kt838-5Kt8Ai-5Kt7X6-5Kt8va-5J5x-hF-5Kxnuu-5Kt7GT-5yQ8V2-5MjGgG-ac5bim-5fEJlv-5Kxnfh-59Ckht-8RnMzX-5JPYLY-bshaq5-GpQYca-352NYf-6aSX12-5kRWVW-8W6rdZ-5Kt7Rg-4sCqbW-5CE3m5-b6YKEB-7ryN1h-4S1sX3-5x8Jw-aAp57n-54jXZY-5nFU1y-6qzNNW-4zg8E1-doau8T-81VVD6-9yCirD-bFc3a8-94eD7x-94eD1x-9oXCan-94gK4g-6G8Xbt-6G8Xgr-6G8Xkz-94gK6a-94gK3c-94eD6c-tSivy2	Tory https://www.flickr.com/photos/chasingbutterflies/	Attribution-ShareAlike 2.0 Generic (CC BY-SA 2.0) https://creativecommons.org/licenses/by-sa/2.0/
294	Steamers (Soft Shell Clams) drawn butter, clam broth https://www.flickr.com/photos/68147320@N02/20641590332/in/photolist-6os5cJ-fggBgw-fggFYY-fg2pLe-qgt9Ui-xtqLrD-xs2xEu-6FKUPo-dR9kAE	T.Tseng https://www.flickr.com/photos/68147320@N02/	Attribution 2.0 Generic (CC BY 2.0) https://creativecommons.org/licenses/by/2.0/
294	Manila Clams https://www.flickr.com/photos/hasari/2411251311/in/photolist-4F5i1t-aHkNs2-q3Qk9C-8ofghF-kNb2Qi-q5qvFU-r2qWZv-4F9wXW-dKN66k-4F5iGg-PY7sh-5sJ98m-8Bp7Se-aywvU-5mUXGj-8Bsey9-pwq14X-aywvA1-bvPN51-6FGaR1-o18qHm-687hPS-omSwch-dMqMES-5FVxfh	Hiro Asari https://www.flickr.com/photos/hasari/	Attribution 2.0 Generic (CC BY 2.0) https://creativecommons.org/licenses/by/2.0/
295	Mussels https://www.flickr.com/photos/tristanf/2682954962/in/photolist-565R3b-499mY1-yqUHK-dJ6v8D-2UbCz7-bp5wMw-eah93w-7NLc4F-7AKDhc-8r5jL9-a47pZ-7woiLz-24PQ7V-8T3uFq-afQsqj-bp5xay-9aLmiw-7C6UFY-4ZNNvi-3nyNBC-axwEdM-MngtJ-7Qq7A9-7nVyTt-4wHQ6o-4tbqMH-7nZwK7-7DksUm-5BLv9g-7nVxTk-47ZnB-6kbfM-3gq9CT-7SJSms-c1ots9-5nkoXV-33pT11-EwUWx-EwVVH-33m8hZ-aTicUn-aTgnAt-aTgq1R-aTieux-9U7Pu-8WVkw-6J8ypP-aTijC2-5aWNSM-fziXj	Tristan Ferne https://www.flickr.com/photos/tristanf/	Attribution 2.0 Generic (CC BY 2.0) https://creativecommons.org/licenses/by/2.0/

Page #	Image Title & Link	Author	License Title
295	<p>oyster</p> <p>https://www.flickr.com/photos/30008779@N03/11296120635/in/photolist-idcz7B-d4E57q-pJzYYm-bK5xR-peH5ZM-4QcwJK-bPTZyZ-52m1Xe-c3Lr6U-6m1QpQ-7nVDAT-arh2DN-byYzCY-7tpR2U-7ut75a-5QWGUe-8orm1m-d1drm-4HUKF-FKHBF-arh2VL-7EYkcG-5XoHbl-3VpybY-oJYbc-5dkSvB-6gbaVW-7DAqJ-4XVctR-5XoHgy-fziMu-5gXDvb-4QgMcW-e1gZrG-9xAnZu-r42KEo-5bvvsG-GV9Qy-4dUc1S-vTVYHM-7rZu8S-5wvMiS-tD9V8c-5cAsdd-bM6e7-trarKD-7b5t3V-j6uagD-8XK65Z-qFA2e4</p>	<p>Kathryn Garson</p> <p>https://www.flickr.com/photos/30008779@N03/</p>	<p>Attribution 2.0 Generic (CC BY 2.0)</p> <p>https://creativecommons.org/licenses/by/2.0/</p>
296	<p>walked the sand with the crustaceans</p> <p>https://www.flickr.com/photos/jim68000/6018736767/in/photolist-aaRAKz-cpsTh3-4Rfj2G-9HADBK-3Rainy-8oMGbj-jzZrfB-dLrLX-iCuFP-DnBZZC-CzNT8r-nGLwVZ-rxP2JK-bxpNnW-aamB6a-68u9g2-d6qZMh-8oMwzh-aqjJoU-aowfCZ-r47Khg-d6r3mb-BuMdv-aWhqrV-8oMG13-a892gG-EMxA3-egyWPR-iP5Ah7-6TZtjK-5qqfH-gRJW-Aa75LF-HcdJGv-8kCC2-xkPUYQ-oGMkQ-rBCETX-vNCRgq-FKxHKJ-jmZy2-Mb7NB-jmZx2-jmZwA-5VHkaY-9g3j2C-p91qEH-7MYRzh-hpQnzY-psbjvE</p>	<p>Jim</p> <p>https://www.flickr.com/photos/jim68000/</p>	<p>Attribution 2.0 Generic (CC BY 2.0)</p> <p>https://creativecommons.org/licenses/by/2.0/</p>
296	<p>Jonah crab</p> <p>https://www.flickr.com/photos/usfwsnortheast/11823580556/in/photolist-j1NWzb-osgUUD-s44Wj6-cm2Wmy-cjyXcC-ff48ev-f4RrMU-beoCuD-oo3PrJ-ePs4uo-8CXsuv-pXqDEU-naxJkU-a1oazs-p3JxgG-nUAQmu-f5GLau-fjhvJ-pHGfKx-nM6W88-boEA7a-nFKaDS-mK873U-qmJ2Pr-eSpcoY-czykGy-onMYMM-n6SAq9-oV48HD-gcn1QT-coyL7-fkX7Tw-fdeJUA-gfjTuE-9d2ncN-dwtwFb-emQ1KD-4vzS1b-bupnyv-foQq5R-bmHzLm-fvRbvo-qfuuxy-aAmCAE-e2Qu5d-nkpb9q-94yLgy-abtyXo-o4MCjz-9xFFfY</p>	<p>U.S. Fish and Wildlife Service Northeast Region</p> <p>https://www.flickr.com/photos/usfwsnortheast/</p>	<p>Attribution 2.0 Generic (CC BY 2.0)</p> <p>https://creativecommons.org/licenses/by/2.0/</p>
296	<p>Red king crab</p> <p>https://www.flickr.com/photos/u-suke/2970929992/in/photolist-5wwMYU-oEagE6-ewchmn-27Pvzn-oEr4yz-onWeUd-7higvF-7PscMY-bhe3tZ-5dSF9k-hWnmMk-a9TvyT-mnqVtc-7XUi49-9efeKg-Hm2JGJ-JmMY5V-tmbnMT-fDynBz-5bdmRW-7KBUiM-6tyhDn-oJJ7qF-212cD3-fDRVjb-933UEX-dZARoE-2e2TWu-933TMP-wzdDwY-oEdxQE-mnqd6V-oGbp7p-4cx9or-qgyfdy-c9kJV-mnr3SF-Egn8Qq-bAF7Ur-EAcRj1-oCpo23-5Viaop-4g3YmR-7Jr7yC-2ExyZs-5Gsxw8-b46F2g-mnsbmY-um3E1a-95e8mX</p>	<p>Yusuke Kawasaki</p> <p>https://www.flickr.com/photos/u-suke/</p>	<p>Attribution 2.0 Generic (CC BY 2.0)</p> <p>https://creativecommons.org/licenses/by/2.0/</p>
296	<p>Dungeness crab</p> <p>https://www.flickr.com/photos/californiadfg/14714671650/in/photolist-oqxhem-7Pg9Tk-7Pk8rA-pl5Y43-4yFJj-pvK8JF-4wPkg-pNfHFu-7Pk8DL-F8D4n-aqqBi1-9q6iyA-5TzqTN-qucQWU-4XAYaa-8TGpnl-5WDwhA-hU3wWi-4wrDk-8YCqUL-4XEUjQ-5LMu5y-8uVgko-8oMGbj-5Ghdi2-7mxXB-jRtbS-5z6dEU-5V2Ddg-aicdz-9aZPnR-bggSup-ahQfBT-2YjPu-5TtuZW-54gjVz-5c9G3u-5Ha17P-4t6E5a-Zk4CP-bNsN6v-7BvD5A-5EzhnB-gjteY5-gjtfaN-5EDA8G-7U2v5w-nKa3uB-bFd3YS-8oMG13</p>	<p>California Department of Fish and Wildlife</p> <p>https://www.flickr.com/photos/californiadfg/</p>	<p>Attribution 2.0 Generic (CC BY 2.0)</p> <p>https://creativecommons.org/licenses/by/2.0/</p>
297	<p>Lobster</p> <p>https://www.flickr.com/photos/fimoculous/2654443910/in/photolist-53yHGj-7t1Tzo-e94ffv-ddUexD-49bKks-4NBLMr-bt6kX-8cFFs5-dyqkny-ddUeMP-56mA2P-4qwtST-4ajAnX-8cCn5x-dyAkmd-dyqkzo-8cCmFF-mTm8h-brgCJc-dyk1Sx-9uK1jN-dkV6nw-4XL4q1-3b297v-5VHkaY-4rLcUm-nGxrU4-pG2KGo-bktUii-pNfXwQ-fapUq1-nL1BzW-3aYDuh-i2ZG3-afwY1q-4t681S-54bGNg-5tkGBR-3mGq1e-8cCmr2-8WXUWY-aGMoa-3JzgAx-eBdv8E-8sGL79-C2j5Gs-bEref-vVtVp-barsD-7bYUCx</p>	<p>Rex Sorgatz</p> <p>https://www.flickr.com/photos/fimoculous/</p>	<p>Attribution 2.0 Generic (CC BY 2.0)</p> <p>https://creativecommons.org/licenses/by/2.0/</p>

Page #	Image Title & Link	Author	License Title
297	Lobsters https://www.flickr.com/photos/naotakem/4896679124/in/photolist-8sGL79-C2j5Gs-bEreF-vVtVp-barsD-7bYUCx-eBxHD-2xL6Cv-8GQf7q-s2rYJT-mTmMP-7cxns4-5zBKqN-xGi9RU-nSxMCR-yARqct-oXFSuP-4EucwD-6zGHkp-4vKLJa-5FR4qN-o3p87L-8bfZd-4EPRKV-7ktws-8uSQ64-85CHuz-6qWzTA-nL2srk-8AEx9-faaEMZ-3aYP35-8zaTzp-o3qYIR-a2nTW-ohwdvA-o1oycS-5YwtmF-fapVpj-e5MrL1-dXC1wx-e6PNqc-faaEZc-fapV3J-6zXXDj-5HNGj4-957Thp-bFJTYn-6qCM3X-95b127	Naotake Murayama https://www.flickr.com/photos/naotakem/	Attribution 2.0 Generic (CC BY 2.0) https://creativecommons.org/licenses/by/2.0/
299	Colors of passion https://www.flickr.com/photos/lullaby_71/9247617909/in/photolist-f6bsC6-2dzBoU-6Wt8JE-fXqsPM-ocmano-c7zUt9-cnTo6N-DyMVC-7AvRb6-bsVeM3-mBr4yN-4iy8xN-7VBDDU-7jLa3A-6CH6F8-e7iq71-53KCva-6wM724-ofnvqc-48ndQP-4PnTB8-6CMeBB-buuBGb-4RNqVV-8BRyq5-85oWpf-bxREqm-4iy6xW-iYMRow-ob8QyZ-4RXH7A-CPq7v-ofmYKV-aqNR-bVtBAy-6iKAok-5Evtfq-7XR3AU-7srQ1o-qMQ4Dd-GPNn1P-5EvtEm-5nd3vJ-cCUREq-7cuvPC-7tsjuk-enJ5fp-8V26HC-dYXdsE-5ndhPb	Giorgio Nicodemo https://www.flickr.com/photos/lullaby_71/	Attribution 2.0 Generic (CC BY 2.0) https://creativecommons.org/licenses/by/2.0/
315	P9240008G-Slow-cooked Pork Roast https://www.flickr.com/photos/galfred/251575500/in/photolist-6LUQj8-HuGcu-7sZgK-7sYRp-4aPUfc-pNgS1U-Hb1iik-jTj22B-9wAfHU-4fna3U-oeoCC-33Pqqw-7AeVMw-2g5vZx-oNcADv-frx4Nf-7vx8qN-fq8PsS	Gail Frederick https://www.flickr.com/photos/galfred/	Attribution 2.0 Generic (CC BY 2.0) https://creativecommons.org/licenses/by/2.0/
315	BBQ pork ribs - after https://www.flickr.com/photos/m0les/5330081480/in/photolist-4f58Vm-imJEyC-9jUW37-39LFMR-oNcADv-9fZND4-48KKLl-48dmz8-5aHvz6-8VCYF8-qTcwCH-5s84hj-8WfTYw-bzWtBX-hJgtiG-tH499-t2UGM-sVgKu-jec11-zi5eq-9814wy-84gK8t-5kmpRY-6VRjff-oG3coS-x4b9Wp-7qnZcg-8fRC6L-4kiESq-EoheT6	Miles Goodhew https://www.flickr.com/photos/m0les/	Attribution 2.0 Generic (CC BY 2.0) https://creativecommons.org/licenses/by/2.0/
315	Gravy https://www.flickr.com/photos/shawnzlea/304498417/in/photolist-sUCLH-h4woDM-7U8jzT-wcCCC-8VCYF8-zMGh4-c3KtES-48TM2d-3nYqm-dZrPtp-4dH1ZX-9ouFbu-9ouFcN-71AvsY-71wv5e-6iHq1d-71wver-71AvKJ-71wvoi-avSRuw-z3YH2z-xBEv7-4f58Vm-BQqDD-71wvF6-6iHqpp-48AVVp-7qFpzZ-6ER6ic-5icgn8-6iHqaA-49ddBD-78TX7B-5FbTps-5Y7o4r-7q1rsd-3fUQe-GQKtb-5G3g25-7UctA-5MhyWp-6RUc6-F-C75Bg-f5P8w2-5N8Muv-6ER5BF-hbcyTv-eZPqT-3nYwt-88Qjoe	Shawn Rossi https://www.flickr.com/photos/shawnzlea/	Attribution 2.0 Generic (CC BY 2.0) https://creativecommons.org/licenses/by/2.0/
315	Making gravy https://www.flickr.com/photos/dinnerseries/5201486349/	Didriks https://www.flickr.com/photos/dinnerseries/	Attribution 2.0 Generic (CC BY 2.0) https://creativecommons.org/licenses/by/2.0/
315, 450	Corn starch https://www.flickr.com/photos/mcleod/11139385806/in/photolist-hYmgjY-dcMBv1-c98gsb-7Xq1fQ-7XmLyT-qHjbza-7Xq1mh-fKxZTF-7Xq1em-6NGsF9-dLQJi-dcMBx7-dUZMct-dLVa1f-iz-VqtJ-dLV9W5-dLPAWk-8HJEax-dLPAZX-dLQJMK-dLVatC-8PGmxD-dLPAfn-dL-PAND-dLQJMK-98EQ8E-dLPAWv-5D4HBe-aTWaxi-3tf5Ht-czKb5-3fR2rU-8gto-Ma-8jiniJ-g53nt8-fCdUbM-zn6Gc-8JesR9-79SGhy-dEKnh3-4avzFj-7y83ny-dLVadJ-d2HfwU-5QVLd7-qig1bE-8PKqU7-2Qdcj2-8C3jne-9QQ6Yy	Scott McLeod https://www.flickr.com/photos/mcleod/	Attribution 2.0 Generic (CC BY 2.0) https://creativecommons.org/licenses/by/2.0/

Page #	Image Title & Link	Author	License Title
315	Salt and Pepper Shakers https://www.flickr.com/photos/jking89/4572668303/in/photolist-7Y57YF-a7hd26-hLBFbC-3i9qBD-7z2a3w-21vsp-e2tPM-9XQTtY-tQpyZ-b2MwkK-pyCDce-sjsMT-q9wwoe-6FFosg-fkcRq-8gbY8x-8Gcfyj-GPRHG-9SxtXR-5SzVEJ-5UEjTj-31MBtc-9SxtXP-751dhQ-5TmKVm-5vRGqM-5vRGnH-ggwwq3-raxrMj-9Zvspo-bn9VwV-2ExVDw-8QGBfJ-9uChxN-5VFs8D-arUhf-rXBBF-dkaytF-65YdSh-EXkE1Q-8THApZ-e4EW7g-b3ssxT-4eAxmD-5xDxC1-4ozy8Z-6rrSSV-9uQ9Bu-7QqQsH-48V65X	Joe King https://www.flickr.com/photos/jking89/	Attribution 2.0 Generic (CC BY 2.0) https://creativecommons.org/licenses/by/2.0/
315	Mixture Pour https://www.flickr.com/photos/dinnerseries/6172466580/in/photolist-aprvGA-5NBCTv-nNxwU7-nMScWf-nMS6rx-xnd4K-adQZHW-7kar6P-9WSyNA-9ZcUEp-4rrJBC-9hQS3R-4VioC1-2PaB7-9EkGaE-i5c-npN-5NyNjh-e19FyW-4EuCXS-7karcx-AAzdh-2yo6Q-9DR5Vn-7vMVuc-8os-BXA-rR7KTF-piYnTW-nMSXLP-qasPEA-fi38i5-4twLbk-atZdiF-8Uonkn-5gcw8i-p3PBdJ-4Qrr5Q-4iQpyJ-8Ni5zh-7JaJPb-Ae7tvf-a4ueu5-7J5wEi-7mJiSM-9WSz6A-8JUuko-81Ki47-byBHqQ-6KBVRS-adQZPA-317x8x	Didriks https://www.flickr.com/photos/dinnerseries/	Attribution 2.0 Generic (CC BY 2.0) https://creativecommons.org/licenses/by/2.0/
321	Control https://www.flickr.com/photos/mrebert/5216094/in/photolist-4wXpus-C5o-SZ-4wSEwZ-2rTc1-7aGCCR-4SkreR-4YphWn-sJyE-6Y8bgP-4wWNW3-8Srfuc-7T2K6z-C5oUB-C5oTJ-4SGiEF-aBypiQ-e3nkdG-3s6vdw-6JWsEb	Ryan Ebert https://www.flickr.com/photos/mrebert/	Attribution 2.0 Generic (CC BY 2.0) https://creativecommons.org/licenses/by/2.0/
321	cutting meat 2 https://www.flickr.com/photos/ryansnyder/6949609007/in/photolist-bA7yCX-7VLR5i-bkiT9L-dYCSBT-bA7yBe-6z6hWc-6gRhr3-a7ePBW-iTkHQ-6gM6AH-38iRyH-9jLwbW-38iSsB-b7oddZ-8zEFey-ra6K2Q-5PVCwG-dHXsaq-ci9wyu-9BvbaX-qWmmwf-2g5xDk-971TE-f3x2bs-7E1AG5-bbFnuA-914kty-5t2BFF-iPthh2-5Yfunh-ci9x3d-61Px6e-ci9wrS-6jCzGR-4fQC4-91WpPi-dHAMuT-di5XxV-914ied-5PRo4k-pXM6ox-2FqXu9-6gM6pT-4EXYfc-6gM6wn-6gRrhys-4F3e8Y-rPywo6-gn7rDk-9U68qP	Ryan Snyder https://www.flickr.com/photos/ryansnyder/	Attribution 2.0 Generic (CC BY 2.0) https://creativecommons.org/licenses/by/2.0/
321	wire brush bristles IMG_9431 https://www.flickr.com/photos/stevendepolo/3053980911/in/photolist-5DSs8i-dPzkY4-dcQorB-b3YWyp-8XaaXq-v23s46-a6Za-Fu-73Eck7-wJsp2J-6Y7MbK-DpsQH8-qo2b4-bD6PwD-8jppqHc-j9QMxb-7X4zt3-amJr2p-9n7V69-2MZgkt-5agjxs-ofQvnx-66enUq-6cKpXt-9qBSZQ-icoZyz-fV18iw-8mwDKB-7pejnz-bAP3Ew-6LWXbk-7pej4T-eETSQv-zgv55R-b55Q3k-rjC8if-dqxF9Q-jiiikNJ-7KU1mb-icoodX-qw7xiY-4BwjW8-icoJ7d-dVhaF6-CvhYj-88biBa-7XPscy-93vboE-aWwtMt-rB6htH-nNucZS	Steven Depolo https://www.flickr.com/photos/stevendepolo/	Attribution 2.0 Generic (CC BY 2.0) https://creativecommons.org/licenses/by/2.0/
321	The Grill: Before https://www.flickr.com/photos/basheertome/2405243418/in/photolist-4Exv57-qxGVF-f8vCjy-mZJvLb-mZG51n-iAGo1g-6sDe8s-4ArFVz-zh6J4a-5cexDu-98Huhb-dw8Byh-5cahsn-2pht6D-8gjVrf-28GvTS-wtimN-4tnCeQ-5pWWHT-6Dc2CU-72UmAJ-6jcEPk-kLqtr-4LUVqE-bsxkZ3-J8ua3-5g6bA9-eckH3c-ejkefd-cCM3am-tnGUd-9LULAU-57hQfz-84SWVi-HwQaH-bC3cLo-9M15xm-5izrCS-kVVFy-9LULQH-5U6vta-6aMMNQ-nYaiTb-EP68W-o7HxQc-JRTBD-5bYggn-EP63Y-9BvbaX-7X3cYk	Basheer Tome https://www.flickr.com/photos/basheertome/	Attribution 2.0 Generic (CC BY 2.0) https://creativecommons.org/licenses/by/2.0/

Page #	Image Title & Link	Author	License Title
321	meat https://www.flickr.com/photos/mccun934/2533451924/in/photolist-4RSAZA-pAPyAe-4DfUr3-quQp7-6upWGs-G3Gsf-rCdDg6-4XTYuy-9AiFyU-7oStLz-56iJGv-8dnLkg-gRaLVy-6upWqC-54MbBA-iYKoLt-as3BxL-6qeX1s-4DbDbc-a2u3L8-9yWRRV-6EaX7m-6upXiQ-54Tumj-rkRE6s-gRaZ7Z-toZ9m-51ApcW-9aFJRY-G3FGm-HoHAH-2AxrkK-a9ywwW7-iYMsuW-q7ksKk-4DfUcj-dGADgH-my5qJ-gyS33-MUyeX-dNniwb-qUwg14-gRaX4R-ms9Ms-8WdXqt-77YAgB-9LVF3L-665gUP-5hf2uj-3nbnzX	Mike McCune https://www.flickr.com/photos/mccun934/	Attribution 2.0 Generic (CC BY 2.0) https://creativecommons.org/licenses/by/2.0/
321	Grill for two https://www.flickr.com/photos/lejoie/2669422642/in/photolist-54Tumj-rkRE6s-gRaZ7Z-toZ9m-51ApcW-9aFJRY-G3FGm-HoHAH-2AxrkK-a9ywwW7-iYMsuW-q7ksKk-4DfUcj-dGADgH-my5qJ-gyS33-MUyeX-dNniwb-qUwg14-gRaX4R-ms9Ms-8WdXqt-77YAgB-9LVF3L-665gUP-5hf2uj-3nbnzX-8WgZPE-669wiA-rkY9qR-7MXpjD-583Q8J-3j5zB-eggnZ-665gUa-oghRqL-5p1ToH-6wqSV1-tnGzG-cFEsQU-9LULhm-mZJxhY-4jE1Xu-6Cry3U-gRb2fc-28Wqvm-mZJAam-6ukM4c-4Exv57-qxGVF	Joel Bez https://www.flickr.com/photos/lejoie/	Attribution 2.0 Generic (CC BY 2.0) https://creativecommons.org/licenses/by/2.0/
328	It's a long story ... https://www.flickr.com/photos/theererin/4285570342/in/photolist-cqjZps-ahp46Y-aba58M-ae3dmw-8jaHeB-dA286Z-65vMqT-4nVXGo-82gyvH-7V2ujg-61nroA-7z7jm-cdRR3S-5sJ2x8-e7n-eNW-7czReS-8Dh8DH-hk5Gv5-7wGKQ-ntQX6W-8jdXNj-nXLY9H-cXCJ7-8jdXUB-4o2Cir-5cSi82-cy2yYJ-hgWbX-mJUac-8Dh6s8-4kfsvj-4RSDd3-32oZ-vX-6jZsWW-6kfA55-q4hoT9-8jdXZ5-qsDiY-8Dh9hH-5tpMTD-BJPB-8DkekU-aesorN-cy2jLE-8uMyF6-cy2tg3-8DkezN-pNXptT-NBt2t-7S6SQf	TheeErin https://www.flickr.com/photos/theererin/	Attribution-ShareAlike 2.0 Generic (CC BY-SA 2.0) https://creativecommons.org/licenses/by-sa/2.0/
328, 349	Vegan Dredging https://www.flickr.com/photos/22865921@N07/2868541879/in/photolist-7n2bWA-5yl28U-9yEdeH-dSV6hu-7Xq1fQ-7XmLyT-cafJ5y-74Ta6H-5cShTt-ooFLZ2-4mYr8U-5yKZ2y-ade7Vu-rnSSBh-j3pKBa-8nm6tY-jXtiMZ-7hDvZr-7Xq1mh-7fyXAi-bWjN7A-7cztHD-aWs7o4-ateDa6-raA9E-9QqzYV-bCQq8g-bVCPz8-7hVeRu-8tJmSs-6sB5R4-unjhe9-5nu2yB-byjTKc-kfEt7-4T8Xmt-7ur4i5-7uqWjs-ydEGL6-6cqrJD-6bP2DD-FYsZB-6mLTX4-7CRjB1-5C4JnD-7MUyMv-B3LDo-AcEQm-ycYRvp-wWmSEw	Nikki L. https://www.flickr.com/photos/22865921@N07/	Attribution 2.0 Generic (CC BY 2.0) https://creativecommons.org/licenses/by/2.0/
328	three hundred fifty degrees fahrenheit: squash cooking temperature https://www.flickr.com/photos/jlodder/5165248707/in/photolist-8Srfuc-4wSEwZ-6Y8bgP-8m4ouK-4wWNW3-9eCgus-e3nkdG-4wXpus-7T2K6z-C5oUB-C5oSZ-4SGiEf-7aGCCR-4SkreR-4YphWn-sJyE-aBypiQ-3s6vdw-6JWsEb	john Lodder https://www.flickr.com/photos/jlodder/	Attribution 2.0 Generic (CC BY 2.0) https://creativecommons.org/licenses/by/2.0/

Page #	Image Title & Link	Author	License Title
328	Mmm... sliders! https://www.flickr.com/photos/jeffreyww/8048385498/in/photolist-ryPu6W-dgd5Bd-dPPZQR-4ZG4x3-aEGF6M-BqdT7o	jeffreyw https://www.flickr.com/photos/jeffreyww/	Attribution 2.0 Generic (CC BY 2.0) https://creativecommons.org/licenses/by/2.0/
328	Steak https://www.flickr.com/photos/adactio/2808912965/in/photolist-5hdpXT-Vcm38-3bmxnu-otj66m-VdBFj-8iMySf-5gcnoY-8LgYxd-696yv4-gn5qS7-7wwGVJ-tSUNF-5iKsi9-52UuwG-ofAGxw-iUSNK-Vcjne-bzWtUg-4STpoh-7L4Kqw-7LgNWV-aUV4A-7HdHc1-6eVffS-9uDEtn-4RswbC-7kLiEb-9ouD95-dXpzfy-dXiU18-g52jM-6gWneR-8Zzmr1-41DmQ-4H2rtG-8hHv7u-qTy3W-5DBUx7-7g8vs-dXiU8P-4GXggR-9TYtVz-bc5Yt-dXiSDn-d3JBkq-7MCVRp-5grH2s-d1GLPh-fAtKcP-dXiT4k	Jeremy Keith https://www.flickr.com/photos/adactio/	Attribution 2.0 Generic (CC BY 2.0) https://creativecommons.org/licenses/by/2.0/
331	Hahn 28cm Non Stick Buffet Saute Pan https://www.flickr.com/photos/cooks-and-kitchens/5023481258/in/photolist-8DUDXQ-8c2Vfv-6hqFzP-dcbYcZ-7mj8Mr-82fab8-bKcJNR-bUySQY-7mo3jj-7oLMzh-3uxeA-953R6T-8xJvVc-7E1AD7-3bPMyn-9wAfHU-9EF4fk-bZsBmN-7DWLze-bfzLbR-qD2xPU-8dg8Jb-pQQjzf-9Vwvb-5x3Pj9-7mj98F-7oGS2P-bKcJGv-7mo3xj-7jaCF2-RGUMV-5UjZMC-4SveJZ-AebYt-8xFTpB-4ud3JG-7fquCg-8aBmdL-5E4RMr-2g5w4g-4Nbq6Q-48Hzjf-8dcQvg-4pDh5Q-6oqp3Q-djHpn2-8bwYiw-69TN9x-8aBm4s-5nJpD4	Cooks & Kitchens https://www.flickr.com/photos/cooks-and-kitchens/	Attribution 2.0 Generic (CC BY 2.0) https://creativecommons.org/licenses/by/2.0/
331	stew meat https://www.flickr.com/photos/46722918@N08/8638682092/in/photolist-eanvdG-hKrwQA-ceHJsW-bs5RnF-89eK-5SZQA2-cBFsEh-8BBUT7-fQ4sSZ-9gz1TJ-7X1Rxd-xjR8K-kPaG1T-fj6dt-dwY1Qm-4rT8Td-4rP5dF-eaofs9-c56YwL-okLryW-bxjSQK-89n2MQ-7foiJD-bSRPjc-64uLnF-iowEs-ceiU2S-7X1QUE-ayXeRe-2gmGdF-c8tVVU-7eAsAi-7eAssV-7X1R4A-sNb6n-8ULEed-9JNFhN-d3wZoG-5m3orW-m2Z97r-7DiBso-H8me4-8V26CS-5m3osd-585Gmq-7ti9um-585H91-5kY7Ma-8wQ5Ns-eoidfC	Carnivore Locavore https://www.flickr.com/photos/46722918@N08/	Attribution 2.0 Generic (CC BY 2.0) https://creativecommons.org/licenses/by/2.0/
331, 349	Oil in the Pan https://www.flickr.com/photos/apreche/3409049959/in/photolist-6cfgMr-6bPp3P-2Ti5H-4qrYA1-7y9JTD-7ydCTN-57pa4W-4dzW25-dUMxcM-6VYHNq-rkTh7a-6VUG9R-6VYKbb-6VUGJF-6VYJrQ-6VUG2n-2Ti5r-6VUHcP-6tz22m-ebLcjG-6VUHsv-PEeNR-eeNDaZ-ffMdGA-ffuCu8-qhQhTZ-iDA9MX-bC8nwb-ffMdmq-dEFhjb-diJgXn-4Fmv93-5HKJ4h-hQNHrH-4JKGWS-3dYt1e-ifada6-psbVLX-61Xq69-4qnUuZ-clfW4f-ffMczJ-if9Pyh-69er8E-az7qPW-nfc41C-4gy3j4-7E1AG5-5xN1Na-ip1qXG	Scott Rubin https://www.flickr.com/photos/apreche/	Attribution 2.0 Generic (CC BY 2.0) https://creativecommons.org/licenses/by/2.0/
331	Meat https://www.flickr.com/photos/nycmominthecity/5216766548/in/photolist-8WZhWQ-78sUrv-ozDe9T-4ExWNw-dHAMUt-59Z48q-c5C3N-5ww1yt-qVHKV1-5wAjns-5wAkxE-4FLjC5-3mrJcx-aU8hkp-5TPqu8-okLryW-7KAFWd-7KAFAA-7KAFFs-5ww2zH-9cgpP7H-4wPduF-5TPqCF-5cjrM3-pXzH56-imJEyC-dricn6-to23S-5TPr7i-6cKpXt-eabCto-dqeUQG-btSv8r-5ww1XV-5ww1aR-4Qmu2W-7KwKme-69Z5mg-5wwZze-p1SAHY-7C2qHq-8VzSzp-mAuJA-7jUMz4-bzrNty-7E1AD7-5JdqFs-8NEAqD-dN1mN7-69Z5Ci	nycmominthecity https://www.flickr.com/photos/nycmominthecity/	Attribution 2.0 Generic (CC BY 2.0) https://creativecommons.org/licenses/by/2.0/

Page #	Image Title & Link	Author	License Title
331	Meat in the frying pan https://www.flickr.com/photos/39908901@N06/7066456645/in/photolist-blRmp-4XPGa6-4rqgXM-kMAQc6-7Es13V-8Kp4RH-dM45kn-9hZH9M-4fUTvy-5Mviv2-8tbHWE-kMAQEa-9b6wAt-84Veo8-7HKz9Y-319chW-5foHar-5wAmm-69Z5yM-4rds52-nw7E4-7DWLze-nuEcep-6HmX7g-84VeBR-7MLLFz-8ULEed-84Ym1W-dqeMFn-n4trpk-62kpht-aquqCC-9Vwvb-g5jxCx-bNmsYB-7t4V1S-axqnv-6qYsm6-5ww1na-69Z54r-4CKoEm-aMK3yF-7jLa3A-7jUMuF-95KgNH-5GU58o-7jGcgp-49qLte-CPq7v-49qLk2	m01229 https://www.flickr.com/photos/39908901@N06/	Attribution 2.0 Generic (CC BY 2.0) https://creativecommons.org/licenses/by/2.0/
331	add some red wine and water to deglaze the pan https://www.flickr.com/photos/austinevan/4120186299/in/photolist-7h61x2-8jvc6b-9Vwvb-7z8vJa-7zchio-9A1LS6-bujCmd-zemJNF-9jnTRT-7h62QP-oeoCC-655nwk	Evan Bench https://www.flickr.com/photos/austinevan/	Attribution 2.0 Generic (CC BY 2.0) https://creativecommons.org/licenses/by/2.0/
349	Chicken Breasts Whole https://www.flickr.com/photos/dinesarasota/3577981798/in/photolist-6sb6km-6uxgix-6s6YhM-6syqwm-56ob32-88hXU9-sghoXZ-88hY3y-88hXxm-88eKn6-88eKoa-88eKme-88hXUY-88eKfZ-88hXT7-88eKgH-88hXW7-62FVDT-9sjJ5d-9sgKc2-8qDUj-bcTtjH-AKnPf-88eKqT-88eKp2-qoVwCb-d2gk1J-bFdbn7-7UTqfp-81yUHN-bcTmT-6gJkbc-oCanr-imMr2R-7va4Nf-7bhsyy-drFiho-8kyNNn-8y3Tyv-6TEhHq-2yziHF-6EvJc-fPqBy-9BxjQH-Hgg66-57Xvma-8i89Xi-5ysz6C-AKnNx-6s6Ych	Larry Hoffman https://www.flickr.com/photos/dinesarasota/	Attribution 2.0 Generic (CC BY 2.0) https://creativecommons.org/licenses/by/2.0/
349	Cooking chicken breasts https://www.flickr.com/photos/84335369@N00/4788273711/	trenttsd https://www.flickr.com/photos/84335369@N00/	Attribution 2.0 Generic (CC BY 2.0) https://creativecommons.org/licenses/by/2.0/
349	DSC_1362 https://www.flickr.com/photos/scottfeldstein/5635763499/in/photolist-9A1L9c-2g9ZdQ-5cWBxY-35g3zU-66TrYG-7WroW4-oDd11n-kFiRZU-hrc8Pc-9VJMD-ncbtwW-2LG3qE-qRRS7E-pS1LH9-7hxNt-cXsCiW-9kyidK-6cqrJD-48Hzjf-7UTqaK-6dal6F-9pRfRH-iP1qXG-9hN6cT-3bPMyn-5xN-1Na-naW2gt-6eWsn2-8Djj1m-8Zzkps-bqvPmh-9wENyD-3bUg4E-4FgBkM-4FgGAX-sSmTs-e6zUdU-oTqaiG-5sEmwZ-5cWBrA-4RcUsq-5qB1BC-qt91VC-6muPnm-3QFMaf-9A4JDh-eXJWDq-6pgWAH-9nXb4Y-9eivLR	scott feldstein https://www.flickr.com/photos/scottfeldstein/	Attribution 2.0 Generic (CC BY 2.0) https://creativecommons.org/licenses/by/2.0/
391	20130424-FNS-RBN-6137 Food and Nutrition Service-Food Distribution Program on Indian Reservations (FDPIR)-Marketing Initiative https://www.flickr.com/photos/usdagov/16019435589/in/photolist-qpzN6k-pnu7EE-4iXpsJ-ifMJQf-7L52fs-qptoLC-dWBQLe-dgcsZo-7KYVTJ-6Ntcnw-6mrFwQ-7KTCvb-hyRTMx-ojtWdU-bz9FrJ-bdkHD2-pvXht7-7KYb4s-7KUenu-6cWXfj-6cSNmH-cN6fb5-avk4eH-avmkaW-azdjw3-o2zr3V-btWnqg-7KQLpg-ayDwZT-bvhFks-dbyzrZ-dbyBVS-eYNh3f-cdxnqA-5Evuf7-e1JRTE-6cSMnK-dWaChJ-7MSh6d-bz9FPW-7KQgKc-7KUK5h-pKgYcw-6Pydb7-bVaF2A-ifMPDw-8m8LP2-bqJcPd-qFRYtP-e496ps	U.S. Department of Agriculture https://www.flickr.com/photos/usdagov/	Attribution 2.0 Generic (CC BY 2.0) https://creativecommons.org/licenses/by/2.0/
427, 328	KitchenShelvesBefore2 https://www.flickr.com/photos/24013072@N05/6439190575/in/photolist-4CQZA4-dHj2qd-ayr14U-d19kVh-dhBNxW-c8EL4d-fhFWFp-dhBMrV-85X14T-b1uyAt-85WZMM-HbvZKf-8RptqK-o33yir-4FgBps-6bdHSL-8RpsHa-7x4XUn-6cWqAd-aP1yfa-9Yx6rP-aP1xEX-aP1Bnp-7uyQHS-aP1wia-4SZi-cJP9i3-7qg9N1-GKP28j-Hd9LVv-4FLku1-5fZBFG-8RsE2N-8RsCeU-4S4RsA-8Rpyjr-8Rpwta-4PpTa2-aP1x2a-6ep9y6-bmMfQj-aT2V52-6fTqud-EhPdZ-Hdhf15	Amy Stephenson https://www.flickr.com/photos/24013072@N05/	Attribution-ShareAlike 2.0 Generic (CC BY-SA 2.0) https://creativecommons.org/licenses/by-sa/2.0/

Page #	Image Title & Link	Author	License Title
438	<p>Recycling</p> <p>https://www.flickr.com/photos/andyarthur/5837677046/in/photolist-9TRC1f-8qUzBR-dkjepU-dk8w9Z-86DdbS-asLU9b-csvtUC-oDF5P5-5pcc4o-ftpVb7-Gz7Aa-g4QdDP-ftpVco-7GaBNw-6oPYRA-ia7NqY-7NuBqg-38yABE-7Neuk-a2hsRH-7JCyw7-dzE8bu-3ZT5ED-dGucPw-hSTJKc-ixx4uf-ixx5BA-dzSKhP-7nwpPL-4a9y5d-5pxwNk-aPX2FM-5974Se-r1pNjt-dzjvUH-9Lx7xq-7cCEwW-7cCw6f-5k4yb3-5Ce6Bz-dk8viZ-87pEW1-bxR2Xz-7WmKPi-9AkH2j-dzCLvY-ntrbYC-6kj52S-ixxrbd-ixxrXo</p>	<p>Andy Arthur</p> <p>https://www.flickr.com/photos/andyarthur/</p>	<p>Attribution 2.0 Generic (CC BY 2.0)</p> <p>https://creativecommons.org/licenses/by/2.0/</p>
442, 443, 444	<p>Yolanda Green Interviews Warehouse Volunteer Joyce Powell.</p> <p>https://www.flickr.com/photos/houstonreuse/4271955266/in/photolist-7vuTt9-asD1WC-fnqxVu-7hbByD-89W4hv-9HawFv-89ZiXQ-9HayxP-9HdqSE-eCrJtd-7CKg3S-6eUYcM-9HaybP-67You4-7BEgm2-9Hdruq-9Hdv3C-7M5RBP-9HazEK-8SeTx1-7K2Ara-7BVLUC-7LNS9T-9HaziZ-CAj2Me-9euHm1-GHX1X7-7BEdT-Bud1UQ-BpdPxx-Bud8t1-9Hdruq-9e3714-9Hduau-9HazH6-9Hdtgu-7bEkBX-6Vm6aR-7BEebP-84YjVy-7bEjBP-7ViQCQ-fCYrKK-9HayDi-7jzjNY-moRDB8-7jzm51-7BJ2tU-7K2yur-7BEgZz</p>	<p>Reuse Warehouse</p> <p>https://www.flickr.com/photos/houstonreuse/</p>	<p>Attribution 2.0 Generic (CC BY 2.0)</p> <p>https://creativecommons.org/licenses/by/2.0/</p>
445	<p>Bakery</p> <p>https://www.flickr.com/photos/86083886@N02/8156987002/in/photolist-dqNG3W-dqNwwa-89jfm8-dqNyK2-8y9Eqd-dqNGEQ-dqNy1g-dqNy7k-dqNxxGn-jfQwj-fkDP7q-7RXJio-dPrFF4-qxRXES-fkyD8m-pnaaAn-4rYU7K-aQWFB2-dqNBjc-6gug2w-67CRMg-qsZaT1-jYmqrv-dKA9Zo-qdHoBY-859R7m-8Wbhaw-7NRPAo-7K1QUp-8NdqB4-qdPCZc-nFEURs-oWauZF-puXQrc-cGuJJE-a5qXqY-btemB7-qoWrxG-dTZakp-pJuDMq-6dCqLC-eyZCvZ-H5wJbX-5rjNAV-4Ew21M-qQkLiU-xAgsf-cBRA1f-93Eef-dqNw8M</p>	<p>StateofIsrael</p> <p>https://www.flickr.com/photos/86083886@N02/</p>	<p>Attribution-ShareAlike 2.0 Generic (CC BY-SA 2.0)</p> <p>https://creativecommons.org/licenses/by-sa/2.0/</p>
447	<p>326 - Kitchen Tile Texture</p> <p>https://www.flickr.com/photos/zooboing/4170674530/in/photolist-7mxNey-o5748p-oHkxtp-8nYNt6-95kQEK-cbHdgW-G6hX-k8Uxg-4hrFRR-cuXVr9-9SaqBV-35xSik-5FnBs6-8o2W6L-dmsyw-82mUDu-jXT5m-fr2Ru-dkeTH2-dKoj3n-ogubCj-8nYDqT-ozKC3V-oxnWAK-9cUAmA-8o2XXf-8nYJJ8-9dotNr-8nYLW4-8nYJyx-6pBmoP-chuYFy-7jvH6U-8nYLyZ-6sFfc-8UsFw1-8nYMS6-h6VmX-8nYE4i-8o2TPf-optGFu-8nYxmx-8o2FKh-8o2GvW-4WekBV-8o2Gpw-8nGj3U-8nYKpH-8o2NuQ-8o2SLb</p>	<p>Patrick Hoesly</p> <p>https://www.flickr.com/photos/zooboing/</p>	<p>Attribution 2.0 Generic (CC BY 2.0)</p> <p>https://creativecommons.org/licenses/by/2.0/</p>
448	<p>flour crossing</p> <p>https://www.flickr.com/photos/cookylida/5144765313/in/photolist-8QCgue-ik191H-49Xk3A-5P7RA5-9npFWf-fwvHRR-jXLSyx-fwvKAB-4s1i2-dQFp2-9znxVb-fyvPc-5KGtc1-7Yi4mw-5xntHi-zVAQ8-MsDee-8jHeqH-r67KCL-4JKygd-fywfo-8ksNJn-cp1ey-b4UPPI-6kWR-jXKE7B-8kSyUE-ayJ7kv-dLHuW-7pwWKR-eoKJy-bVhRkC-dttYsr-bJ11M-5fstT1-7MH-gNN-95hfuq-97yKJo-8kPnNa-8kPnSX-4JiaAC-jW35mM-jW2Uu4-dtfSWR-HEjQNb-6aNiYC-dpQLfy-fQkneh-bAdMwU-9AVHi8</p>	<p>ella</p> <p>https://www.flickr.com/photos/cookylida/</p>	<p>Attribution 2.0 Generic (CC BY 2.0)</p> <p>https://creativecommons.org/licenses/by/2.0/</p>
449	<p>fat-collection</p> <p>https://www.flickr.com/photos/tellumo/232317103/</p>	<p>Adam Engelhart</p> <p>https://www.flickr.com/photos/tellumo/</p>	<p>Attribution-ShareAlike 2.0 Generic (CC BY-SA 2.0)</p> <p>https://creativecommons.org/licenses/by-sa/2.0/</p>

Page #	Image Title & Link	Author	License Title
461	Pie Crust https://www.flickr.com/photos/kimberlykv/2295733998/in/photolist-4uSeJE-5qjVva-7B785U-pDbk9D-h4MsS-49Rnw7-h4MHj-hRmrua-2wAZ6-aKzLgp-bUX2QQ-5JitLK-B4Qh1W-7BWDzh-aW1E8r-5t1D6h-pECE3o-9bMGLL-49RnjW-5XXx8a-6zThq9-49Rnbj-9i3jbM-8wUPrw-aW1EeR-ndi7pt-7C1FEw-8RHPRd-4zm95V-KtQ6C-b9Gf3R-3a8vUE-4ooM7C-fQ6vkV-58iMj8-5bj3xq-6S3iWK-ahpzX8-5amX9E-94ERpz-5Ka6q2-6x1rnN-eYqPTj-iDqv-6Nu49A-aHgZhK-F9eQ2L-4ojHsn-ahy71D-6NkfpC	Kimberly Vardeman https://www.flickr.com/photos/kimberlykv/	Attribution 2.0 Generic (CC BY 2.0) https://creativecommons.org/licenses/by/2.0/



Special Thanks



PROFESSIONALISM - CULINARY FRENCH VOCABULARY - WORDMATCH

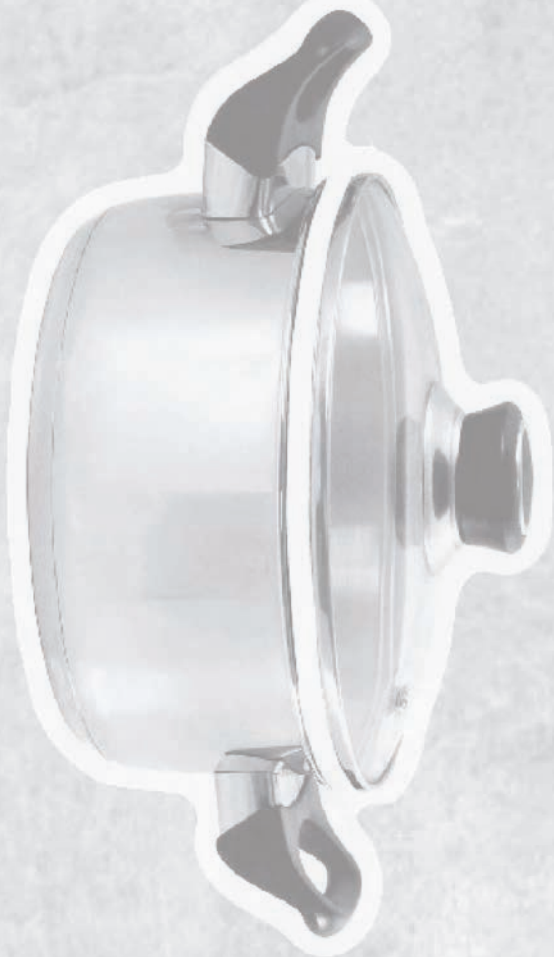

**PROFESSIONALISM - THE CLASSIC KITCHEN VOCABULARY -
WORDMATCH**



SOUPS, STOCKS & SAUCES - STOCKS - WORDMATCH EXERCISE

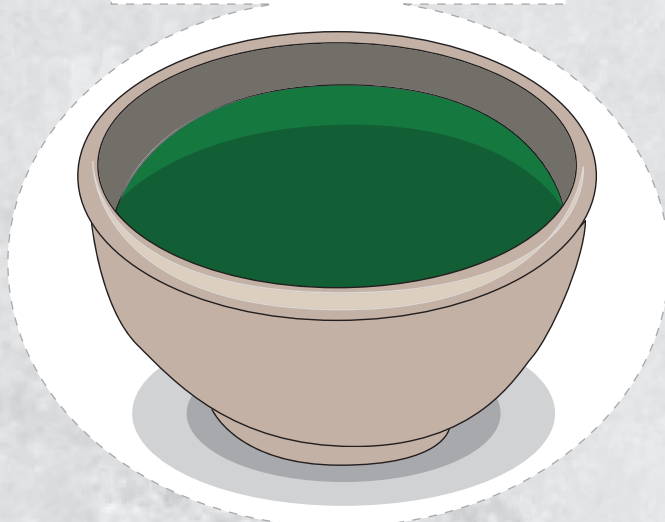
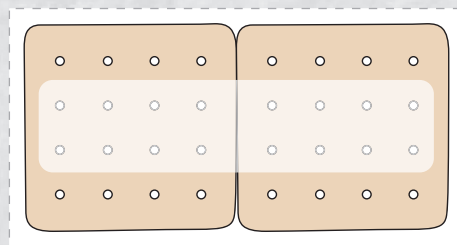
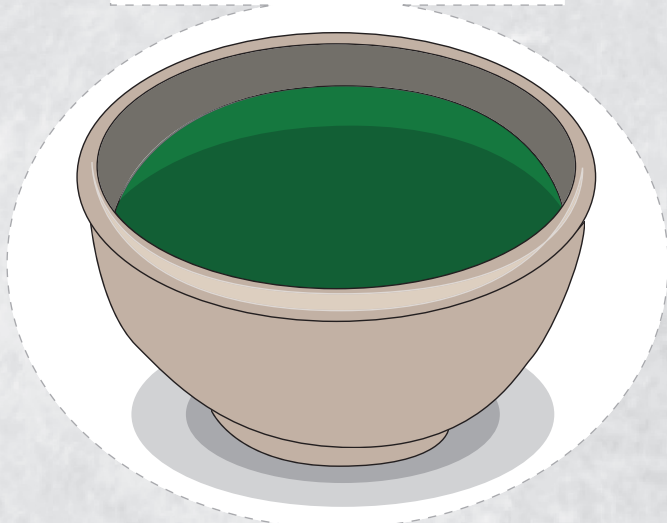
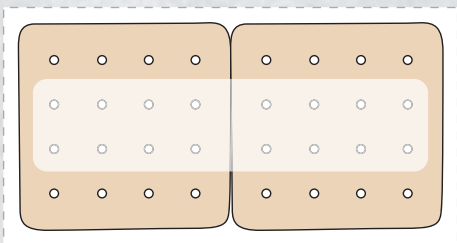
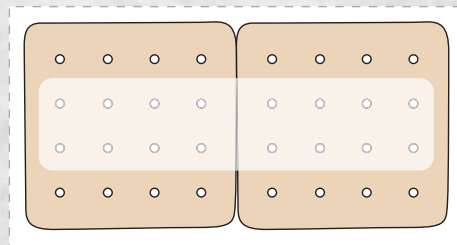
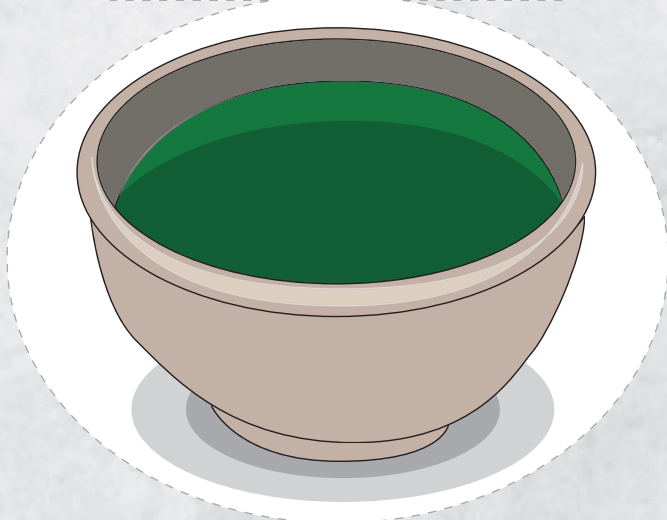
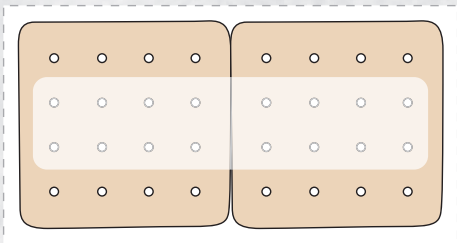

**MEAT & POULTRY COOKERY - POULTRY VOCABULARY -
TERMS & DETAILS MATCH**

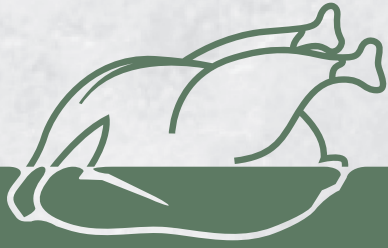

A large, empty white rectangular box with rounded corners, intended for a student to write a definition or detail for the turkey above.

A large, empty white rectangular box with rounded corners, intended for a student to write a definition or detail for the turkey above.

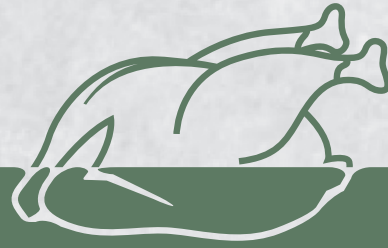
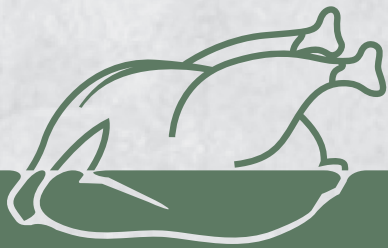

A large, empty white rectangular box with rounded corners, intended for a student to write a definition or detail for the turkey above.

A large, empty white rectangular box with rounded corners, intended for a student to write a definition or detail for the turkey above.

**BFS & KM - BASIC SEASONING AND FLAVOURING TECHNIQUES –
WORDMATCH**



11 x 17 Posters & Board Games

PAGE 68 - TEMPATURE DANGER ZONE - 11 X 17 POSTER

PAGE 72 - PROPER HANDWASHING PROCEDURE - 11 X 17 POSTER

PAGE 77 - SAFE BEHAVIOUR ON THE JOB - 11 X 17 POSTER

PAGE 148 - SHOOTS & LADDERS EXERCISE - 11 X 17 BOARD GAME

PAGE 260 - HOT & COLD SANDWICHES - 11 X 17 POSTER

Temperature Danger Zone

The temperature danger zone is:

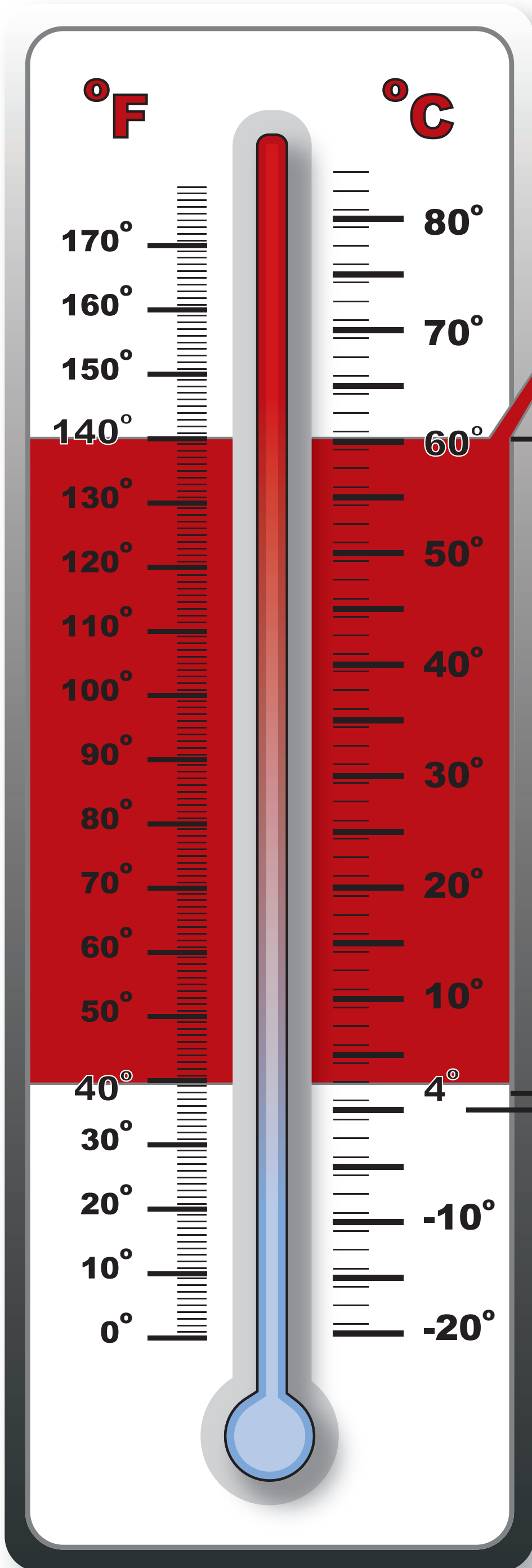

The broad range of temperatures at which bacteria multiply rapidly

Between **4° Celsius** and **60° Celsius** or

40° Fahrenheit and **140° Fahrenheit**

DANGER ZONE

0° Freezer Temperature

LEGEND

°F = Fahrenheit

°C = Celsius

Proper Hand Washing Procedures



1

**Use hot running water
Wet hands and forearms**



2

**Apply soap
Rub hands and arms briskly with soapy
lather for at least 20 seconds**

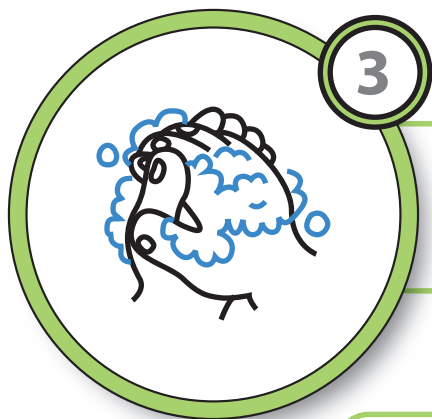

3

**Scrub between fingers and clean nails
with a clean nail brush**



4

**Rinse thoroughly under hot running
water**



5

**Reapply soap and scrub hands and
forearms for another 5 to 10 seconds**



6

Rinse again

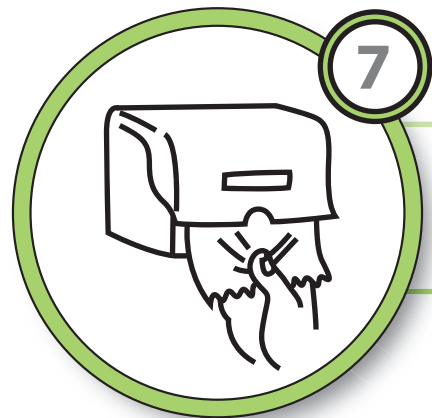

7

**Dry hands and arms using a
single-use towel**



8

**Use the towel to turn off the water
Discard the towel in a trash bin**

SAFE BEHAVIOUR ON THE JOB

SAFETY
IS YOUR RESPONSIBILITY
THIS KITCHEN HAS WORKED
DAYS
WITHOUT A LOST TIME INJURY
THE BEST PREVIOUS RECORD WAS
DAYS
DO YOUR PART TO BETTER THE RECORD

SAFETY FIRST
CLEAN UP

SPILLS

● Clean up spills as soon as they occur

Learn to operate equipment properly; always use guards and safety devices

WARNING

Do not use unless guards are in position

DO NOT WEAR JEWELRY OR LOOSE CLOTHING WHEN OPERATING

● Wear clothing that fits properly; avoid wearing jewelry, which may get caught in equipment

BE CAREFUL

WALK! DON'T RUN

● Walk, do not run

Keep exits, aisles and stairs clear and unobstructed

Use knives and other equipment for their intended purpose only

SAFETY FIRST
WORK CAREFULLY WITH KNIVES

PLEASE
KEEP ALL AISLES CLEAN AND CLEAR OF OBSTRUCTIONS

CAUTION

HOT!

● Always assume a pot or pan is hot; handle with dry towels

● Position pot and pan handles out of the aisles so they do not get bumped

Get help or use a cart when lifting or moving heavy objects

Avoid back injury by lifting with your leg muscles; stoop, do not bend, when lifting

HOW TO LIFT CORRECTLY

<p>THE RIGHT WAY</p> LEGS BENT, BACK KEPT AS STRAIGHT AS POSSIBLE, LOAD CLOSE TO BODY, GRIPPED AT OPPOSITE CORNERS	<p>THE WRONG WAY</p> LEGS STRAIGHT, BACK BENT, PUTS ALL THE STRAIN ON THE MUSCLES OF THE BACK & ABDOMEN
--	---

LADDER RULES

- ALWAYS FACE LADDER WHEN ASCENDING OR DESCENDING
- USE AT LEAST ONE HAND TO GRASP LADDER
- TOP OF LADDER SHOULD NEVER BE USED AS A STEP
- LADDERS SHOULD NEVER BE MOVED, SHIFTED, OR EXTENDED WHILE OCCUPIED
- NEVER CARRY AN OBJECT OR LOAD THAT COULD CAUSE YOU TO LOSE YOUR BALANCE

● Use a well placed ladder or stool for climbing; do not use a chair, box, drawer or shelf

● Keep breakable items away from food storage or production areas

● Warn people when you must walk behind them, especially when carrying a hot pan



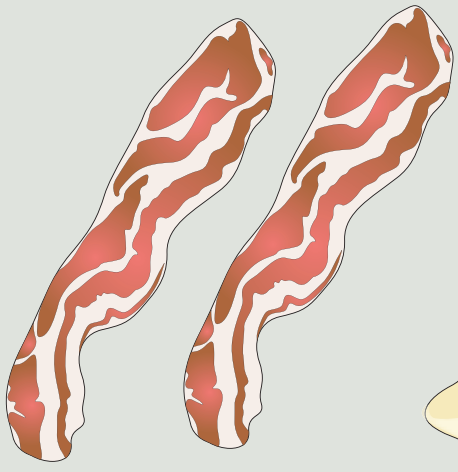

Bacon & Eggs Boardgame

100	99	98	97	96	95	94	93	92	91
81	82	83	84	85	86	87	88	89	90
80	79	78	77	76	75	74	73	72	71
61	62	63	64	65	66	67	68	69	70
60	59	58	57	56	55	54	53	52	51
41	42	43	44	45	46	47	48	49	50
40	39	38	37	36	35	34	33	32	31
21	22	23	24	25	26	27	28	29	30
20	19	18	17	16	15	14	13	12	11
1	2	3	4	5	6	7	8	9	10

Game pieces

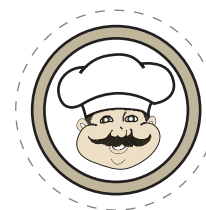

HOT or COLD Sandwiches

Sandwiches must be prepared under strict sanitation and hygiene conditions because they are generally served uncooked.

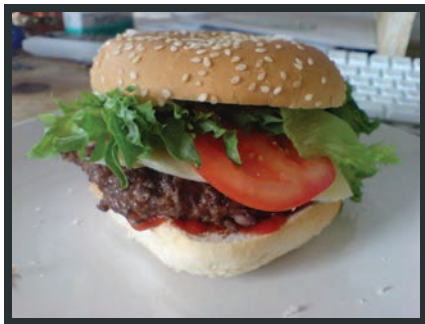

GENERAL RULES:

- 1: Correct sanitation procedures observed.
- 2: Only quality products used.
- 3: All products are fresh.
- 4: Moisture balance is correct.
- 5: Proper work methods have been followed, particularly with respect to neatness, productivity and convenience.
- 6: The product is appealing to the eye; your sandwich should be neat, arranged appeal and garnished appropriately.
- 7: Portion size is appropriate.
- 8: The cost of food is within the range allotted for it.

Freshness is one of the major qualities desired, whether the sandwich is prepared to order or mass produced. You should carefully estimate the number of sandwiches you need in a day and never keep or use sandwiches that are over twenty four hours old.

BREADS

As well as ensuring that the bread is fresh, it is also desirable to use a variety of breads in sandwich making.



SPREADS

Spreads softened butter or margarine to the edges of the bread slices. Softened butter, margarine, cream cheese and peanut butter will form a protective coating that prevents moist fillings from soaking the bread.

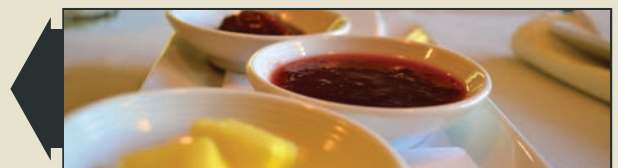

Mayonnaise or salad dressing, if spread directly onto the bread will also soak into the soggy bread.

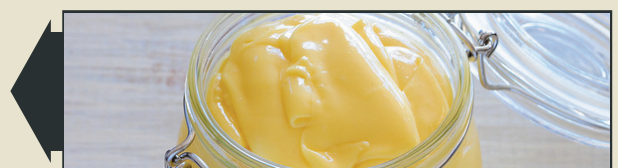

Avoid melted butter or margarine, as these will soak into the bread and make a soggy sandwich.



FILLINGS

Make sure fillings are applied evenly across the bread slice and that enough is used to make the sandwich attractive and appetizing.

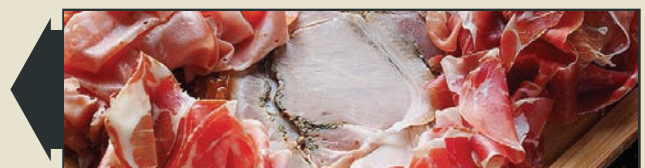

Ensure that the filling is neither too dry nor too moist, and that it is correctly seasoned. Make sure that moist fillings such as tuna or egg salad have an easy to spread consistency.



Greens such as lettuce and watercress should be used only in sandwiches that are to be eaten at once.

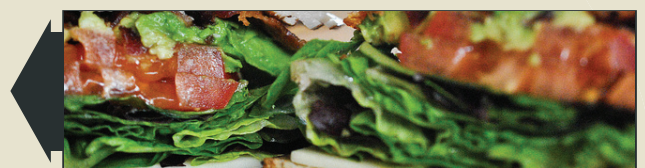

HOT FILLINGS

The most common type of hot filling is probably the hamburger patty. It is important to remember that when making a sandwich with a hot filling that you ensure the filling is hot. The filling should be cooked until the internal temperature reaches at least 74 degrees C before being removed from the cooking surface. The product may then be held at a temperature not lower than 60 degrees C.

