

BIM Project Execution Planning Guide, Version 3.0 - Under
Development

BIM Project Execution Planning Guide, Version 3.0 - Under Development

JOHN MESSNER, CHIMAY ANUMBA, CRAIG DUBLER, SEAN GOODMAN, COLLEEN
KASPRZAK, RALPH KREIDER, ROBERT LEICHT, CHITWAN SALUJA, AND NEVENA ZIKIC

Construction Innovation Center, Penn State
University Park, PA, USA



BIM Project Execution Planning Guide, Version 3.0 - Under Development by Computer Integration Construction Research Program is licensed under a [Creative Commons Attribution-ShareAlike 4.0 International License](https://creativecommons.org/licenses/by-sa/4.0/), except where otherwise noted.

Contents

Sign Up for Guide Updates	vii
Executive Summary	1
Authors and Contributors	3
Reader's Guide	4
Acknowledgements	5
Citation	7
1. Overview of the BIM Execution Planning Procedure for Building Information Modeling	8
2. Establish Project Modeling Goals	16
3. Select Model Uses	18
4. Design the BIM Process	24
5. Define the Information Exchanges	31
6. Plan Infrastructure	35
7. Implementing the BIM Project Execution Planning Procedure	43
8. BIM Project Execution Planning for Organizations	46
9. Conclusions and Recommendations	49
Appendix A: BIM Goals Worksheet	51
Appendix B: Model Use Descriptions	52
Appendix B-1: Model Use: Monitor System Performance	54
Appendix B-2: Model Use: Monitor Space Utilization	55
Appendix B-3: Model Use: Monitor Assets	57
Appendix B-4: Model Use: Monitor Maintenance	59
Appendix B-5: Model Use: Compile Record Model	61
Appendix B-6: Model Use: Layout Construction Work	63
Appendix B-7: Model Use: Fabricate Product	64
Appendix B-8: Model Use: Author Temporary Construction Systems Model	66
Appendix B-9: Model Use: Author Construction Site Logistics Model	67

Appendix B10: Model Use: Draw Construction Documents	69
Appendix B-11: Model Use: Analyze Sustainability Performance	70
Appendix B-12: Model Use: Review Design Model(s)	72
Appendix B-13: Model Use: Coordinate Design Model(s)	74
Appendix B-14: Model Use: Analyze Lighting Performance	76
Appendix B-15: Model Use: Analyze Structural Performance	77
Appendix B-16: Model Use: Analyze Energy Performance	79
Appendix B-17: Model Use: Author 4D Model	81
Appendix B-18: Model Use: Author Cost Estimate	83
Appendix B-19: Model Use: Analyze Program Requirements	85
Appendix B-20: Model Use: Author Design	86
Appendix B-21: Model Use: Capture Existing Conditions	87
Appendix B-22: Additional Model Use: Analyze Site Selection Criteria	89
Appendix B-23: Model Use: Analyze Engineering Performance	91
Appendix B-24: Additional Model Use: Validate Code Compliance	93
Appendix B-25: Additional Model Use: Analyze Emergency Management	95
Appendix C: Model Use Analysis Worksheet	97
Appendix D: Process Map Templates	99
Appendix E: Example Process Maps for Sample Laboratory Project	116
Appendix F: Information Exchange Worksheet	122
Appendix G: BIM Project Execution Plan Template	127
Appendix H: BIM Execution Planning Category Comparison	128
Appendix I: Version History	130
Appendix J: Links to All Template Documents	132
Appendix K: Citations and Sources for Additional Information	133
Appendix L: Glossary	134

Sign Up for Guide Updates

We like to keep everyone informed of revisions to our BIM Guide Series, along with other research and continuing education events related to BIM. Please sign up to be on our email list for all updates at the link below.

[Link to Sign Up for BIM Guide Updates](#)

Executive Summary

A Building Information Model (BIM) is *“a digital representation of physical and functional characteristics of a facility.”* To successfully implement BIM, a project team must perform detailed and comprehensive planning. A well-documented BIM Project Execution Plan (BEP) will ensure that all parties are clearly aware of the opportunities and responsibilities associated with the incorporation of BIM into the project workflow. A completed BEP should define the appropriate Model Uses for a project (e.g., author design model, design review, and 3D coordination), along with a detailed design and documentation of the process for executing BIM throughout a facility's lifecycle. Once the plan is created, the team can follow and monitor their progress against this plan to gain the maximum benefits from BIM implementation.

This Guide provides a structured procedure, as displayed in Figure i-1, for creating and implementing a BEP. The five steps within the procedure include:

1. Define the goals for the implementation of BIM;
2. Identify high-value Model Uses during project planning, design, construction, and operational phases;
3. Design the BIM execution process by creating process maps;
4. Define the information deliverables; and
5. Develop the infrastructure in the form of contracts, communication procedures, technology, and quality control to support the implementation.

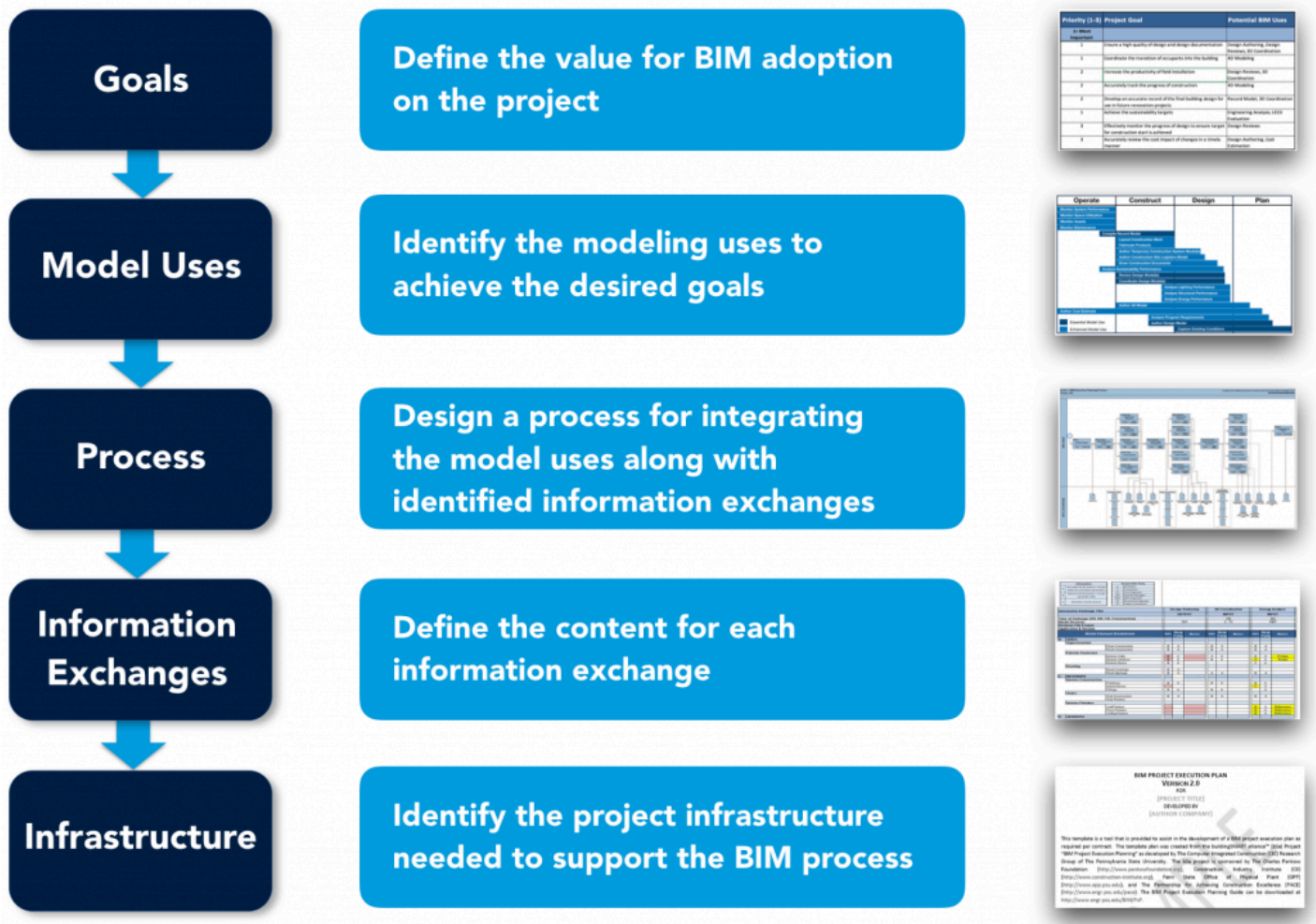

Figure i-1: BIM Project Execution Planning Procedure

The objective for following the structured procedure is to stimulate planning and direct communication among the project team members during the early phases of a project. The team leading the planning process should include members from all organizations with a significant role in the project. Since there is no single best method for BIM implementation on every project, each team must effectively design a tailored execution strategy by understanding the project goals, the project characteristics, and the capabilities of the team members.

This BIM Project Execution Planning Guide is a product of the BIM Project Execution Planning Project within the [buildingSMART alliance™ \(bSa\)](#), a council within the [National Institute of Building Sciences](#). The bSa is charged with developing the [National Building Information Modeling Standard – United States™ \(NBIMS-US\)](#). This Guide was developed to provide a practical manual that can be used by project teams to design their BIM strategy and develop a BEP. The core modeling and information exchange concepts have been designed to complement the long-term goals of the bSa in the development of a standard that can be implemented throughout the AECOO Industry to improve the efficiency and effectiveness of BIM implementation on projects.

Authors and Contributors

A team of individuals within the Computer Integrated Construction (CIC) Research Program at Penn State developed this Guide. Principle authors of the Guide include:

- John Messner, Ph.D., Director, CIC Research Program and Charles & Elinor Matts Professor of Architectural Engineering, Penn State, Principle Investigator of the original project to develop the Guide
- Chimay Anumba, Ph.D., Former Professor and Head, Department of Architectural Engineering, Penn State
- Craig Dubler, Ph.D., Former Graduate Research Assistant, Penn State
- Shane Goodman, Former Research Assistant, Penn State
- Colleen Kasprzak, Former Graduate Research Assistant, Penn State
- Ralph Kreider, Ph.D., Former Graduate Research Assistant, Penn State
- Robert Leicht, Ph.D., Associate Professor of Architectural Engineering, Penn State
- Chitwan Saluja, Former Graduate Research Assistant, Penn State
- Nevena Zikic, Former Graduate Research Assistant, Penn State

The [Computer Integrated Construction Research Program website](https://cic.psu.edu) (<https://cic.psu.edu>) includes contact information for the authors.

Additional Contributors:

- Project Advisory Board Members (see [Acknowledgements](#))
- Students in the 2008 and 2010 Penn State AE 597G Graduate Class on BIM Execution Planning

Reader's Guide

This Building Information Modeling (BIM) Project Execution Planning Guide is directed toward readers with a fundamental understanding of BIM concepts.

The nine chapters in this Guide provide:

- An overview of the BIM Project Execution Planning Procedure ([Chapter One](#))
- An approach to define the project modeling goals ([Chapter Two](#))
- A method to identify Model Uses ([Chapter Three](#))
- A procedure for designing the BIM Process for the project ([Chapter Four](#))
- A method for defining the Information Exchange Requirements ([Chapter Five](#))
- An approach to define the infrastructure necessary to support the BIM Process ([Chapter Six](#))
- A structured method for team implementation of the procedure through a series of meetings and intermediate tasks ([Chapter Seven](#))
- A structured approach for organizations to development typical plans for BIM implementation ([Chapter Eight](#))
- Conclusions and Recommendations for projects and organizations implemented BIM based on lessons learned through the creation of the Guide ([Chapter Nine](#))

The appendices provide additional resources for implementing the BIM Project Execution Planning Procedure on a project. These resources include electronic templates for completing each step within the process. There are also example process maps and information exchange examples for a sample project. The sample project used is a hypothetical laboratory project with a limited number of Model Uses so that it is easy to understand.

The electronic resources are available for download from Appendix. The templates include Microsoft Excel spreadsheets for various template files, a Microsoft Visio file with template process models, and an Adobe PDF template form for completing an execution plan. Project teams can use these templates to develop their BIM Project Execution Plan or copy appropriate content to any customized organizational documents.

Acknowledgements

The research team would like to thank the sponsors and project Advisory Board Members for their support of the BIM Project Execution Planning Guide project. The team also wishes to thank the students at Penn State who have contributed to portions of this guide, as well as the industry members who have participated in surveys, interviews and case studies related to the project.

SPONSORS:

- [The Charles Pankow Foundation](#)
- [Construction Industry Institute \(CII\)](#)
- [Penn State Office of Physical Plant \(OPP\)](#)
- [The Partnership for Achieving Construction Excellence \(PACE\)](#)

ADVISORY BOARD MEMBERS FOR VERSION 1, VERSION 2.0, AND VERSION 2.1:

- Deke Smith, Previous Executive Director of [buildingSMART alliance™](#) (Industry Champion)
- Victor Sanvido, Ph.D., Senior Vice President, Southland Industries (Industry Champion)
- Mark Butler, Previous Chair, US National CAD Standard Project Committee, Systems Integration Manager, and Senior Professional Associate, HDR, Inc.
- Derek Cunz, Director of Project Development, Mortenson Construction
- Mark Falzarano, CAD Coordinator, Barton Malow Company
- Ed Gannon, Manager of Design Services, Penn State Office of Physical Plant
- Greg Gidez, Corporate Design Manager, Hensel Phelps Construction Co.
- Francois Grobler, Ph.D., US Army Civil Engineering Research Lab
- Steve Hagan, Project Knowledge Center, U.S. General Services Administration
- Steve Hutsell, Chief, Geospatial Section, Seattle District, US Army Corps of Engineers
- Mark Konchar, Vice President, Balfour Beatty Construction
- Soad Kousheshi, President, AEC Strategy
- Kurt Maldovan, Balfour Beatty Construction
- Alexander Zolotov, Skanska

SPONSOR DIRECTORS:

- Robert Tener, Previous Executive Director, The Charles Pankow Foundation
- Steve Thomas, Previous Associate Director, Construction Industry Institute

Citation

Messner, J., Anumba, C., Dubler, C., Goodman, S., Kasprzak, C., Kreider, R., Leicht, R., Saluja, C., and Zikic, N. (Under Development). *BIM Project Execution Planning Guide, Version 3.0*. [Computer Integrated Construction Research Program](http://bim.psu.edu), The Pennsylvania State University, University Park, PA, USA, Available at <http://bim.psu.edu>.

Overview of the BIM Execution Planning Procedure for Building Information Modeling

INTRODUCTION TO BUILDING INFORMATION MODELING

Building Information Modeling (BIM) is a process focused on the development, use, and transfer of a digital information model of a building project to improve the design, construction, and operations of a project or portfolio of facilities. The National Building Information Modeling Standards (NBIMS) Committee defines BIM as:

“... a digital representation of physical and functional characteristics of a facility. A BIM is a shared knowledge resource for information about a facility forming a reliable basis for decisions during its life-cycle; defined as existing from earliest conception to demolition. A basic premise of BIM is the collaboration by different stakeholders at different phases of the life cycle of a facility to insert, extract, update or modify information in the BIM to support and reflect the roles of that stakeholder.”

When properly implemented, BIM can provide many benefits to a project. The value of BIM has been illustrated through well-planned projects which yield: increased design quality through effective analysis cycles; greater prefabrication due to predictable field conditions; improved field efficiency by visualizing the planned construction schedule; increased innovation through the use of digital design applications; and many more. At the end of the construction phase, valuable information can be used by the facility operator for asset management, space planning, and maintenance scheduling to improve the overall performance of the facility or a portfolio of facilities. Yet, there have also been examples of projects where the team did not effectively plan the implementation of BIM and incurred increased costs for the modeling services, schedule delays due to missing information, and little to no added value. Implementing BIM requires detailed planning and fundamental process modifications for the project team members to successfully achieve the value from the available model information.

BIM can be implemented at many phases throughout a project, but the current technology, training, and costs of implementation relative to added value must always be considered when determining the appropriate areas and levels of detail needed in the information modeling processes. Teams should not focus on whether or not to use BIM in general, but instead, they need to define the specific implementation areas and uses. A team should aim to implement BIM at the level needed to maximize value while minimizing the cost and impact of the modeling implementation. This requires the team to selectively identify appropriate areas for BIM implementation and plan these implementation areas in detail.

WHY SHOULD THE PROJECT TEAM DEVELOP A BIM PROJECT EXECUTION PLAN?

To effectively integrate BIM into the project delivery process, it is important for the team to develop a detailed execution plan for BIM implementation. A BIM Project Execution Plan (hereinafter referred to as the ‘BIM Plan’)

outlines the overall vision along with implementation details for the team to follow throughout the project. The BIM Plan should be developed in the early stages of a project; continually developed as additional participants are added to the project; and monitored, updated, and revised as needed throughout the implementation phase of the project. The plan should define the scope of BIM implementation on the project, identify the process flow for BIM tasks, define the information exchanges between parties, and describe the required project and company infrastructure needed to support the implementation.

By developing a BIM Plan, the project and project team members can achieve the following value:

1. All parties will clearly understand and communicate the strategic goals for implementing BIM on the project
2. Organizations will understand their roles and responsibilities in the implementation
3. The team will be able to design an execution process which is well suited for each team member's business practices and typical organizational workflows
4. The plan will outline additional resources, training, or other competencies necessary to successfully implement BIM for the intended uses
5. The plan will provide a benchmark for describing the process to future participants who join the project
6. The purchasing divisions will be able to define contract language to ensure that all project participants fulfill their obligations
7. The baseline plan will provide a goal for measuring progress throughout the project.

BIM, like other new technologies, can carry some level of additional process risk when implemented by teams that are not experienced with the implementation process, or if people are not familiar with the strategies and processes of their team members. Ultimately, the entire team will gain value through the increased level of planning by reducing the unknowns in the implementation process thereby reducing the overall risk to all parties and the project.

THE BIM PROJECT EXECUTION PLANNING PROCEDURE

This guide outlines a five-step procedure to develop a detailed BEP. The procedure is designed to steer owners, program managers, and early project participants through a structured process to develop detailed, consistent plans for projects. This procedure was developed through a multi-step research process which included industry interviews with over 40 industry experts, detailed analysis of existing planning documents, focus group meetings with industry participants, process mapping research to design an efficient and effective mapping structure, and case study research to validate the procedure.

The five steps, shown in Figure 1-1, consist of identifying the appropriate BIM goals and uses on a project, designing the BIM execution process, defining the BIM deliverables, and identifying the supporting infrastructure to successfully implement the plan. These steps are introduced in the following sections, and then a chapter in this guide is dedicated to explaining the details related to each step. Detailed templates have also been created to support each of these steps. These templates are available on the project website as well as the printed examples included in the Appendices of this guide.

identified through analysis of project case studies, interviews with industry experts, and review of the literature. A BIM Use is a unique task or procedure on a project which can benefit from the integration of BIM into that process. The twenty-five identified uses are not comprehensive but provide a good representation of the current uses of BIM within the industry. Several examples of BIM Uses include design authoring, 4D modeling, cost estimating, space management and record modeling. The team should identify and prioritize the appropriate BIM Uses which they have identified as beneficial to the project. The procedure for identifying BIM Goals and Uses is discussed in further detail in [Chapter Three](#) of this guide.

DESIGN THE BIM EXECUTION PROCESS

Once the team has identified the Model Uses, a process mapping procedure for planning the BIM implementation needs to be performed. Initially, a high-level map showing the sequencing and interaction between the primary BIM Uses on the project is developed (see Figure 1-2). This allows all team members to clearly understand how their work processes interact with the processes performed by other team members.

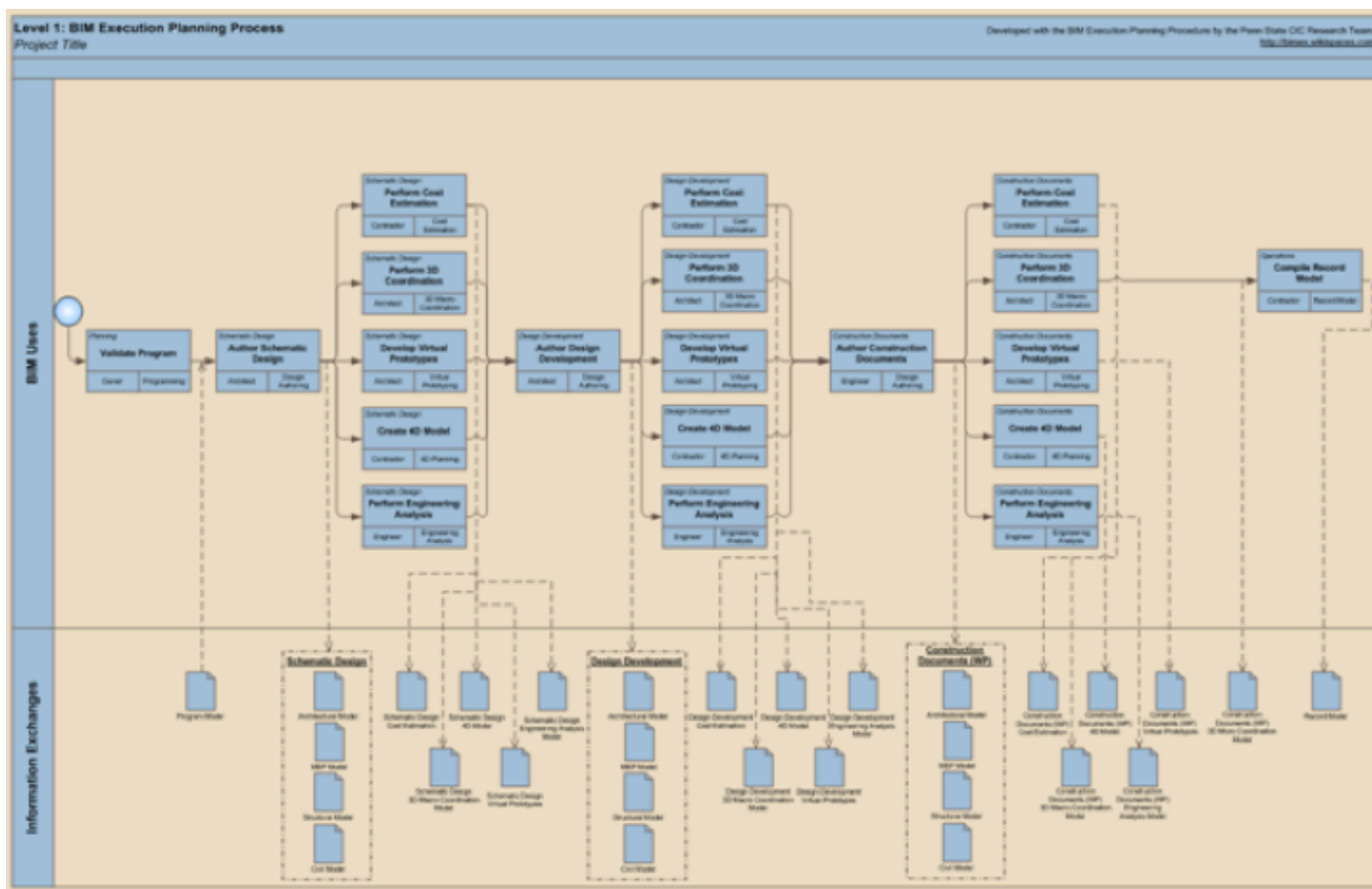

Figure 1.2: High-Level BIM Use Map (see [Chapter 4](#) for full-size image)

After the high-level map is developed, then more detailed process maps should be selected or designed by the team members responsible for each detailed BIM Use. For example, the high-level map will show how the BIM authoring, energy modeling, cost estimating, and 4D modeling are sequenced and interrelated. A detailed map will show the detailed process that will be performed by an organization or, in some cases, several organizations,

such may be the case for energy modeling. The procedure for designing the BIM execution process is discussed in further detail in [Chapter Four](#) of this guide.

DEVELOP INFORMATION EXCHANGES

Once the appropriate process maps have been developed, the information exchanges which occur between the project participants should be clearly identified. It is important for the team members, in particular, the author and receiver for each information exchange transaction, to clearly understand the information content. This information content for the exchange can be defined in the Information Exchange table a portion of which is displayed as an example in Figure 1-3. The procedure for defining the information exchanges is discussed in further detail in [Chapter Five](#) of this guide.

INFORMATION EXCHANGE WORKSHEET

Information		Responsible Party	
A	Accurate Size & Location, include materials and object parameters	A	Architect
B	General Size & Location, include parameter data	C	Contractor
C	Schematic Size & Location	CV	Civil Engineer
		FM	Facility Manager
		MEP	MEP Engineer
		SE	Structural Engineer
		TC	Trade Contractors

Information Exchange Title	Record Modeling	4D Modeling	3D Coordination	Design Authoring
Time of Exchange (SD, DD, CD, Construction)	Construction	CD	CD	CD
Model Receiver	FM	C	C, TC	ALL
Receiver File Format				
Application & Version				

Model Element Breakdown		Info	Resp Party	Additional Information	Info	Resp Party	Notes	Info	Resp Party	Notes	Info	Resp Party	Notes
A	SUBSTRUCTURE												
	Foundations												
				Standard Foundations									
				Special Foundations									
				Slab on Grade									
	Basement Construction												
				Basement Excavation									
				Basement Walls									
B	SHELL												
	Superstructure												
				Floor Construction									
				Roof Construction									
	Exterior Enclosure												
				Exterior Walls									
				Exterior Windows									
				Exterior Doors									
	Roofing												
				Roof Coverings									
				Roof Openings									
C	INTERIORS												
	Interior Construction												
				Partitions									
				Interior Doors									
				Fittings									
	Stairs												
				Stair Construction									

Figure 1.3: Portion of the Information Exchange Spreadsheet template

DEFINE SUPPORTING INFRASTRUCTURE FOR BIM IMPLEMENTATION

After the BIM uses for the project have been identified, the project process maps are customized, and the

BIM deliverables are defined, the team must develop the infrastructure needed on the project to support the planned BIM process. This will include the definition of the delivery structure and contract language; defining communication procedures; defining the technology infrastructure; and identifying quality control procedures to ensure high-quality information models. The procedure for defining the infrastructure along with methods to implement and track progress is discussed in further detail in [Chapter Six](#) of this guide.

WHAT INFORMATION IS INCLUDED IN A BIM PROJECT EXECUTION PLAN?

When complete, the BIM Plan should address the following categories of information:

- **BIM Project Execution Plan Overview Information:** Document the reason for creating the Project Execution Plan.
- **Project Information:** The Plan should include critical project information such as project numbers, project location, project description, and critical schedule dates for future reference.
- **Key Project Contacts:** As part of the reference information, A BIM Plan should include contact information for key project personnel.
- **Project Goals / BIM Objectives:** This section should document the strategic value and specific uses for BIM on the project as defined by the project team in the initial step of the planning procedure. Additional information regarding this category is included in Chapter Two.
- **Organizational Roles and Staffing:** One of the primary tasks is to define the coordinator(s) of the BIM planning and execution process throughout the various stages of the project. This is particularly important when identifying the organization(s) who will initiate the development of the BIM Plan, as well as the required staff to successfully implement the plan.
- **BIM Process Design:** This section should clearly illustrate the execution process through the use of process maps which are developed in the second step of the planning procedure. Additional information regarding this category is included in Chapter Three.
- **BIM Information Exchanges:** The model elements and level of detail required to implement each BIM Use should be clearly defined in the information exchanges requirements. Additional information regarding this category is included in Chapter Four.
- **BIM and Facility Data Requirements:** The owner's requirements for BIM must be documented and understood.
- **Collaboration Procedures:** The team should develop their electronic and collaboration activity procedures. This includes the definition of model management procedures (e.g., file structures, and file permissions) as well as typical meeting schedules and agendas.
- **Model Quality Control Procedures:** A procedure for ensuring that the project participants meet the defined requirements should be developed and monitored throughout the project.
- **Technology Infrastructure Needs:** The hardware, software and network infrastructure required to execute the plan should be defined.
- **Model Structure:** The team should discuss and document items such as model structure, file naming structure, coordinate system, and modeling standards.
- **Project Deliverables:** The team should document deliverables required by the owner.
- **Delivery Strategy / Contracts:** This section should define the delivery strategy which will be used on

the project. The delivery strategy, e.g., design-build vs. design-bid-build, will impact implementation and it will also impact the language which should be incorporated into the contracts to ensure successful BIM implementation.

Note: These items are discussed in further detail in [Chapter Six](#) of this guide.

WHO SHOULD DEVELOP THE BIM PLAN?

To develop the BIM Plan, a planning team should be assembled in the early stages of a project. This team should consist of representatives from all the primary project team members including the owner, designers, contractors, engineers, major specialty contractors, facility manager, and project owner. It is very important for the owner, as well as, all primary team members to fully support the planning process. For the initial goal setting meetings, key decision-makers should be represented from each of the organizations so that the overall goals and vision for implementation on the project are clearly defined for further planning initiatives. Once this initial goal setting is complete, then the detailed implementation processes and information exchanges can be developed and implemented by the lead BIM coordinators for each of the parties.

The lead party for coordinating and compiling the BIM Plan should be clearly identified. This role may vary based on the project delivery method, the timing of the BIM Plan development, and the expertise of the participants. Parties who may lead this planning initiative could include the owner, architect, program manager, or construction manager. For some projects, it may be beneficial to have an initial party start the planning, e.g., the owner may begin the planning prior to contracting with additional parties for their services, and then the BIM Plan may be transitioned and completed by another party, such as the construction manager or architect. In some circumstances, it may be beneficial to contract with a third party to facilitate the planning procedure if the team is inexperienced or the team finds it beneficial to have a facilitator for the planning activities.

WHAT MEETINGS ARE NEEDED TO SUCCESSFULLY DEVELOP THE BIM PLAN?

The BIM Plan for the project cannot be developed in isolation. No one party within the project team can adequately outline the execution plan, while also obtaining the necessary team member commitments for successful BIM implementation. In order to have a successful project using BIM, full coordination and collaboration by all parties is an absolute necessity. The planning team should conduct a series of planning meetings to develop the execution plan. On most projects, a minimum of two or three meetings will be needed to develop the overall BIM Plan. The initial meeting will need to have key decision-makers for all organizations. Follow-up meetings will require fewer people, and be more targeted on the details related to execution. A detailed outline of a series of four meetings for developing the BIM Plan is included in Chapter 6 of this guide and includes template agendas and interim activities to be performed by the planning team.

HOW DOES THE BIM PLANNING PROCEDURE INTEGRATE WITH THE NATIONAL BIM STANDARD?

The National Building Information Modeling Standard – United States™ (NBIMS-US) is currently being developed by the buildingSMART alliance™, a part of the National Institute for Building Sciences. The goal of the NBIMS-US is to identify and define standard information exchanges that are required on facility projects. The BIM Planning Procedure is designed to complement the standard exchange requirements under development in the NBIMS-US initiative. Ultimately, the vision will be that a project team can seamlessly integrate the information exchanges in the NBIMS-US with Step 3 of this execution planning procedure which focuses on Information Exchange Requirements. As the information exchanges become standardized throughout the industry, the third step of this

Establish Project Modeling Goals

The first step in developing a BIM Project Execution Plan is for the project team to identify the core reasons 'why' BIM can improve the overall delivery process and operations of the project.

SET THE BIM GOALS FOR THE PROJECT

The project team should outline project goals along with their potential relationship to BIM implementation. These project goals should be specific to the project at hand, measurable, and strive to improve success in the planning, design, construction, and operations of the facility. One category of goals may relate to general project performance including reducing the project schedule duration, reducing the project cost, or increasing the overall quality of the project. Examples of quality goals include the development of a more energy-efficient design through the rapid iteration of energy modeling, creating higher quality installed designs through detailed 3D coordination of systems, or developing more accurate record models to improve the quality of performance modeling and commissioning.

Other goals may target the efficiency of specific tasks to allow for overall time or cost savings by the project participants. These goals include the use of modeling applications to create design documentation more efficiently, to develop estimates through automated takeoffs, or to reduce the time to enter data into the maintenance system. These items are only suggestions of potential goals that the project team may have when beginning to decide how to implement BIM on a project. It is by no means a comprehensive list, and it is essential to identify the specific goals that will provide an incentive for implementing BIM on the project.

A hypothetical new Laboratory Building constructed on a university campus will be used throughout the following three chapters to illustrate the steps in this guide. Sample project goals from this example project are shown in Table 2-1. Additionally, a blank Project Goals Worksheet is provided in [Appendix A](#).

Table 2.1 - Sample Project Goals for a Laboratory Building Project with Potential BIM Uses

Project Goals (EXAMPLE)

Priority (1-3)	Project Goal	Potential BIM Uses
1= Most Important		
1	Ensure a high quality of design and design documentation	Design Authoring, Design Reviews, 3D Coordination
1	Coordinate the transition of occupants into the building	4D Modeling
2	Increase the productivity of field installation	Design Reviews, 3D Coordination
2	Accurately track the progress of construction	4D Modeling
2	Develop an accurate record of the final building design for use in future renovation projects	Record Model, 3D Coordination
1	Achieve the sustainability targets	Engineering Analysis, LEED Evaluation
3	Effectively monitor the progress of design to ensure target for construction start is achieved	Design Reviews
3	Accurately review the cost impact of changes in a timely manner	Design Authoring, Cost Estimation

It is important to understand that some goals may relate to specific uses, while others may not. For example, if there is a project goal to increase field labor productivity and quality through large amounts of prefabrication, then the team can consider the '3D Design Coordination' Model Use which will allow the team to identify and correct potential geometric conflicts before construction. On the other hand, if the team's goal was to increase the sustainability of the building project, several uses may assist in accomplishing that goal.

Select Model Uses

The goal of this chapter is to provide a method for identifying appropriate Model Uses given the project situation.

DESCRIPTION OF MODEL USES

Twenty-one Model Uses, organized by project phase, have been identified and refined through numerous interviews with industry experts, analysis of implementation case studies, and review of the literature (reference Figure 3-1). It is important to note that there are many more potential uses for modeling on the project so a team should not limit themselves to this list of uses. It is also important to note that very few teams would implement all of these model uses, but they are uses that are being implemented on projects. Within Figure 3-1, the model uses that have been identified in the National BIM Guide for Owners as 'Essential Model Uses' have been included in dark blue boxes. The team should give very strong consideration to implementing these uses.

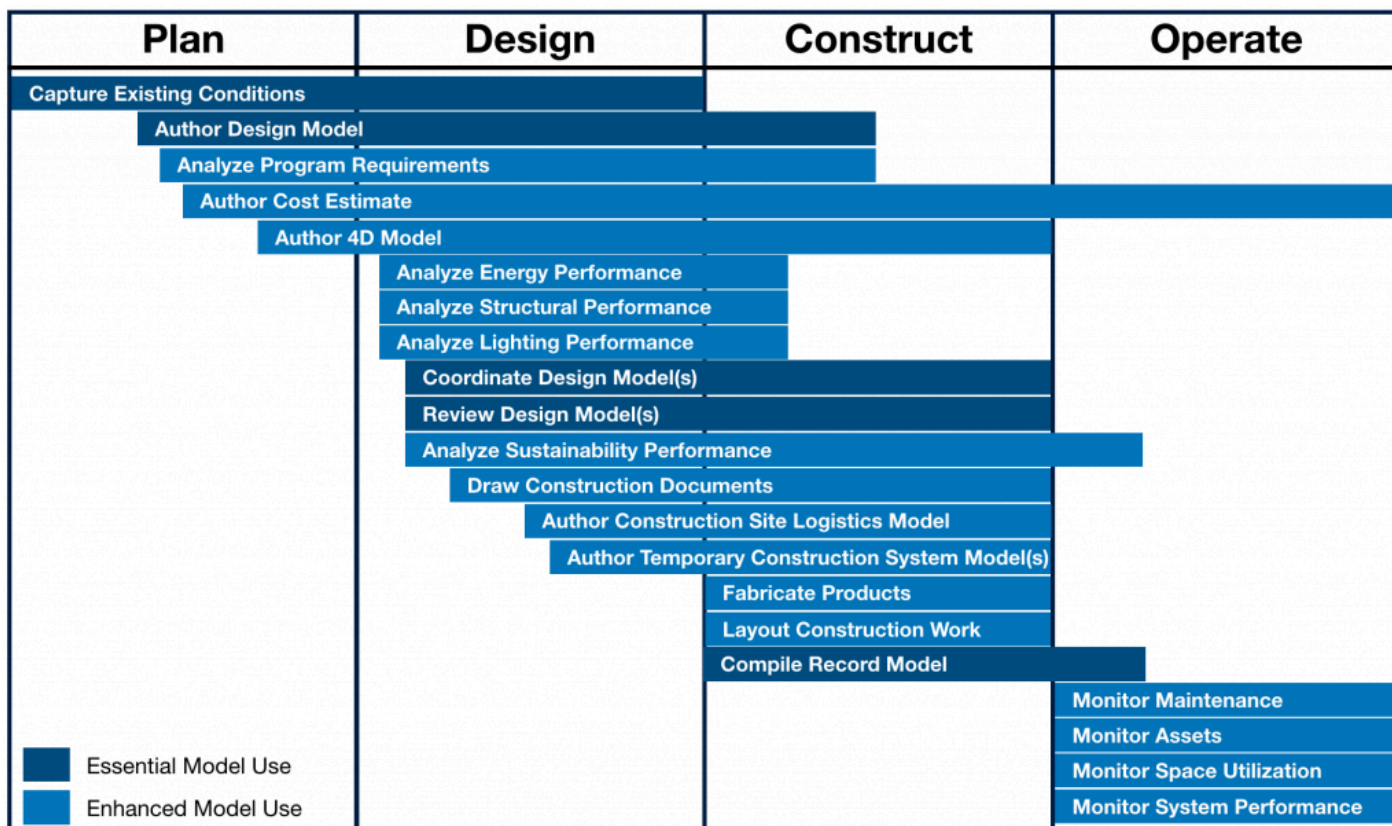

Common Model Uses by Project Phase

Note: Dark Blue are Essential Model Uses as defined in the National BIM Guidelines for Owners

Figure 3.1: Common Model Uses by Project Phase

A brief summary-level description of each of these Model Uses is included in [Appendix B](#). These descriptions were developed to provide a brief overview for project team members who may not be familiar with the Model Use, and to provide additional information that the project team may find valuable during the selection process. Each description includes an overview of the Model Use, potential benefits, required team competencies, and selected resources that can be referenced for additional information about the Model Use. An example of a Model Use description is shown in Figure 3-2.

Cost Estimation
<p>Description:</p> <p>A process in which a BIM model can offer a reasonable accurate quantity take-off and cost estimate early in the design process and provide cost effects of additions and modifications with potential to save time and money and avoid budget overruns. This process also allow designers to see the cost effects of their changes in a timely manner which can help curb excessive budget overruns due to project modifications.</p>
<p>Potential Value: (improvements in project / process)</p> <ul style="list-style-type: none"> • Precisely estimate material quantities and generate quick revisions if needed • Stay within budget constraints with frequent preliminary cost estimates while the design progresses • Better visual representation of project and construction elements that need to be estimated: taken off and priced • Provide cost information to the owner during the early decision making phase of design • Focus on more value adding activities in estimating like identifying construction assemblies, generating pricing and factoring risks then quantity take-off, which are essential for high quality estimates • Exploring different design options and concepts within the owner's budget • Saving estimator's time and allowing to focus on more important issues in an estimate since take-offs can be automatically provided • Quickly be able to determine costs of specific objects
<p>Resources Required:</p> <ul style="list-style-type: none"> • Model-based Estimating Software • Design Authoring Software • Cost Data
<p>Competencies Required:</p> <ul style="list-style-type: none"> • Ability to define specific design modeling procedures which yield accurate quantity take-off information

Figure 3.2: Sample Model Use Description (see [Appendix B](#) for full descriptions)

BEGIN WITH THE END IN MIND

For BIM to be implemented successfully, it is critical that team members understand the future use(s) of the information that they are developing. For example, when an architect adds a wall to the architectural model, that wall may carry information regarding the material quantities, mechanical properties, structural properties, and other data attributes. The architect needs to know if this information will be used in the future, and if so, how it will be used. The future use of this data can frequently impact the methods used to develop the model, or identify quality control procedures related to the data accuracy for tasks relying on the information.

To emphasize the lifecycle of the information, a core concept of the planning procedure is to identify the appropriate uses of modeling by beginning with the potential end-uses of the information in the model. To do so, the project team should first consider the later phases of a project to understand what information will be valuable to have during that phase. Then, they can move back through all of the project phases in reverse order (Operate, Construct, Design, and then Plan) as shown in Figure 3.3. This perspective to 'begin with the end in mind' will identify the downstream desired uses of information which should be supported by earlier processes in the lifecycle of the project. By identifying these downstream Model Uses first, the team can focus on identifying reusable project information and important information exchanges.

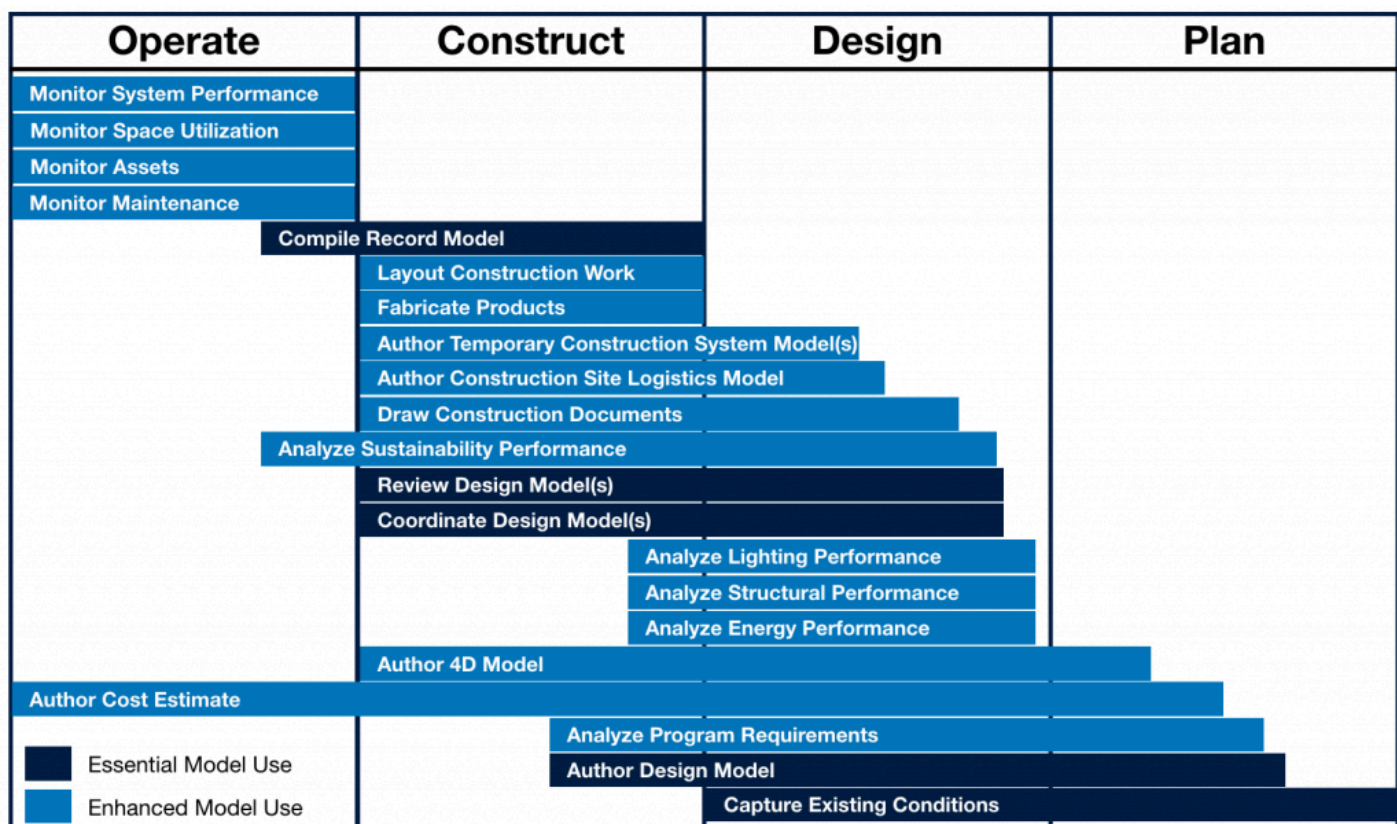

Common Model Uses - Beginning with the Operations Phase
 Note: Dark Blue are Essential Model Uses as defined in the National BIM Guidelines for Owners

Figure 3.3: Common Model Uses (organize in reverse chronological order by project phase)

MODEL USE SELECTION PROCEDURE

Once the goals are defined, the project team should identify the appropriate tasks that the team would like to perform using BIM. This analysis of Model Uses should initially focus on the desired outcomes for the overall process. Therefore, the team should begin with the operate phase, and identify the value for each of the Model Uses as it specifically relates to the project by providing a High, Medium or Low priority to each use. The team can then progress to each preceding project phase (construct, design, and plan).

To help facilitate this Model Use review process, a Model Selection Worksheet has been developed. This template includes a list of the potential Model Uses, along with fields to review the value, responsible party, capabilities, additional notes, and the decision from the team on whether to implement the Model Use. Please reference Figure 3.4 for an example of the Model Use Selection Worksheet on the example Laboratory Project.

BIM Use*	Value to Project	Responsible Party	Value to Resp Party	Capability Rating			Additional Resources / Competencies Required to Implement	Notes	Proceed with Use
				Resources	Competency	Experience			
	High / Med / Low		High / Med / Low	Scale 1-3 (1 = Low)					YES / NO / MAYBE
Record Modeling	HIGH	Contractor	MED	2	2	2	Requires training and software		YES
		Facility Manager	HIGH	1	2	1	Requires training and software		
		Designer	MED	3	3	3			
Cost Estimation	MED	Contractor	HIGH	2	1	1			NO
4D Modeling	HIGH	Contractor	HIGH	3	2	2	Need training on latest software Infrastructure needs	High value to owner due to phasing complications Use for Phasing & Construction	YES
3D Coordination (Construction)	HIGH	Contractor	HIGH	3	3	3			YES
		Subcontractors	HIGH	1	3	3	conversion to Digital Fab required	Modeling learning curve possible	
		Designer	MED	2	3	3			
Engineering Analysis	HIGH	MEP Engineer	HIGH	2	2	2			MAYBE
		Architect	MED	2	2	2			
Design Reviews	MED	Arch	LOW	1	2	1		Reviews to be from design model no additional detail required	NO
3D Coordination (Design)	HIGH	Architect	HIGH	2	2	2	Coordination software required	Contractor to facilitate Coord.	YES
		MEP Engineer	MED	2	2	1			
		Structural Engine	HIGH	2	2	1			
Design Authoring	HIGH	Architect	HIGH	3	3	3			YES
		MEP Engineer	MED	3	3	3			
		Structural Engine	HIGH	3	3	3			
		Civil Engineer	LOW	2	1	1	Large learning curve	Civil not required	
Programming	MED						Planning Phase Complete	NO	

* Additional BIM Uses as well as information on each Use can be found at <http://www.engr.psu.edu/ae/cic/bimex/>

Figure 3.4: Model Use Selection Worksheet Example (Partial List)

MODEL USE SELECTION WORKSHEET COMPLETION PROCEDURE

To complete the Model Use Selection Worksheet, the team should proceed through the following steps with key project stakeholders (see Chapter Six for details about meeting structure.)

1. Identify the potential Model Uses

Definitions and explanations for each Model Use are available by project phase in [Appendix B](#). It is important that the team consider each of the potential uses and consider their relationship with the project goals.

2. Identify the responsible parties for each potential Model Use

For each Model Use that is being considered, at least one responsible party should be identified. The responsible parties include any team members who will be involved in the use if it is performed, along with potential outside participants that may be needed to assist with the implementation. List the lead responsible party first in the spreadsheet.

3. Rate the capabilities of each party for each Model Use identified in the following categories

a. Resources – Does the organization have the resources necessary to implement the Model Use required? Some of the general resources required include:

- Personnel – Modeling Team
- Software
- Software Training
- Hardware
- IT support

b. Competency – Does the responsible party have the know-how to successfully implement the specific Model Use? To determine competency, the project team should understand the details for the Model Use and how it will be carried out on the specific project.

c. Experience – Has the responsible party performed the Model Use in the past? The team experience associated with each Model Use is vital to the success of the implementation.

4. Identify additional value and risk associated with each Model Use

The team should consider the potential value gained, as well as, additional project risk that may be incurred by proceeding with each Model Use. These value and risk elements should be incorporated into the 'notes' column of the Model Use Selection Worksheet.

5. Determine whether or not to implement each Model Use

The team should discuss each Model Use in detail to determine whether or not the Model Use is appropriate for the project given its characteristics (both project and team). This will require that the team determine the potential added value or benefit to the project and then compare this potential benefit to the cost of implementation. The team will also need to consider the risk elements associated with implementing or not implementing each particular Model Use. For example, some Model Uses can significantly reduce overall project risk, however, they may shift risk from one party to another. In other situations, the implementation of a BIM Use may potentially add risk for a party when they successfully perform their scope of work. Once all factors are considered, the team needs to make a 'go / no go' decision related to each Model Use. Also understand that as the team decides to perform several Model Uses, others may become easier to implement because the team members can leverage existing information. For example, if the architectural design is authored in a 3D parametric modeling application, then it is less expensive to implement 3D design coordination.

Design the BIM Process

After identifying each Model Use, it is necessary to understand the implementation process for each Model Use and the implementation process of the project as a whole. This chapter describes a procedure to design the BIM Project Execution Process. The process map developed in this step allows the team to understand the overall BIM process, identify the information exchanges that will be shared between multiple parties, and clearly define the various processes to be performed for the identified BIM Uses. The use of process mapping techniques allows the team to effectively perform this step. Process maps also serve as the basis for determining other important implementation topics including contract structure, model deliverable requirements, information technology infrastructure, and selection criteria for future team members.

Mapping the Project Execution Process

Mapping the BIM Process for the project requires the project team to first develop an overview map which shows how the different Model Uses will be performed. Then, detailed BIM Use Process Maps are developed to define the specific BIM implementation at an increased level of detail. To implement this two-level approach, Business Process Modeling Notation (BPMN) has been adopted so that consistently formatted process maps will be created by the various project team members.

Level 1: BIM Overview Map

The Overview Map shows the relationship of Model Uses on the project. This process map also contains the high-level information exchanges that occur throughout the project lifecycle.

Level 2: Detailed BIM Use Process Maps

Detailed BIM Use Process Maps are created for each identified BIM Use on the project to clearly define the sequence of various processes to be performed. These maps also identify the responsible parties for each process, reference information content, and the information exchanges which will be created and shared with other processes.

Creating a BIM Overview Map

This section details out how to create a BIM Overview Map.

1) Place potential BIM Uses into a BIM Overview Map

Once the team identifies the Model Uses for the project (refer to the Model Use Selection Worksheet from Chapter Three), the team can start the mapping process by adding each of the Model Uses as a process within the map. It is important to understand that a Model Use may be added to the overview map at several locations if it is performed at several times within the project lifecycle.

To help achieve this task, a template Microsoft Visio file containing process maps is published at the BIM Project Execution Planning Guide Website. A Microsoft Visio Stencil file is also posted in the same location and can be used by the project team to develop the process maps easily. If the project team members do not have Microsoft Visio, the team can use other process mapping or graphics software to create the process maps. Additionally, versions of the templates are in [Appendix D - Template Process Maps](#).

2) Arrange Model Uses according to project sequence in the BIM Overview Map

After developing the process for each implemented model use on the project, the team should sequentially order these processes. One of the purposes of the Overview Map is to identify the phase for each Model Use (e.g., plan, design, construct or operate) and provide the team with the implementation sequence. For simplistic purposes, the Model Uses should align with the BIM deliverables schedule.

3) Identify the responsible parties for each process

Responsible Parties should be clearly identified for each process. For some processes, this may be an easy task, but for others, it may not. It is important in all cases to consider which team member is best suited to successfully complete the task. Additionally, some processes may have multiple responsible parties. The identified party will be responsible for clearly defining the information required to implement the process as well as the information produced by the process.

The graphical notation and information format for the processes within the BIM Overview Map are included in Figure 3-1. Each process should include a process name, project phase, and the responsible party. Each process should also include a 'Detailed Map' title which points to the detailed map (Level Two map) for the process. This detailed map notation is used since several processes may share the same detailed map. For example, a construction management company may perform cost estimating from the building information provided by the designer. The Construction manager may perform this estimate during the schematic design, design development, and construction document phase, but it may use the same detailed workflow to accomplish this task, which can represent a single detailed map. Therefore, the process for performing the three estimates should be added into the high-level map at three locations, but the team can reference a single detailed map for further information.

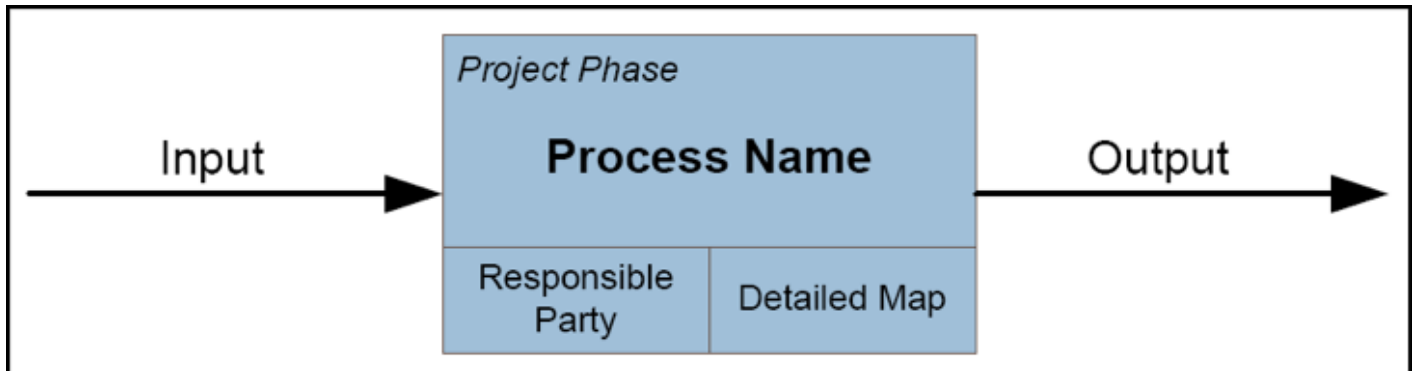

Figure 3.1: Notation for a Process in the Overview Process Map

4) Determine the Information Exchanges required to implement each BIM Use

The BIM Overview Map includes the critical information exchanges which are either internal to a particular process or shared between processes and responsible parties. In general, it is vital to include all information exchanges that will pass from one party to another. In current applications, these exchanges are typically implemented through the transfer of a data file, although it could also include the entry of information into a common database. All the information exchanges identified in the BIM Overview Map should be detailed, as defined in Chapter Five. The exchanges which originate from a process box are exchanges which are internal to a process. The exchanges which originate or flow into the sequence line are external exchanges which are shared between high-level processes. For example, Figure 3-2 shows information exchanges arising from the 'Perform 3D Coordination' process box for the Laboratory Project. These exchanges, although internal to the 3D Coordination Process, should be identified in the BIM Overview Map since multiple parties author the exchanged information. This ensures that the exchanges will be detailed using the information exchange definition procedure described in Chapter Five.

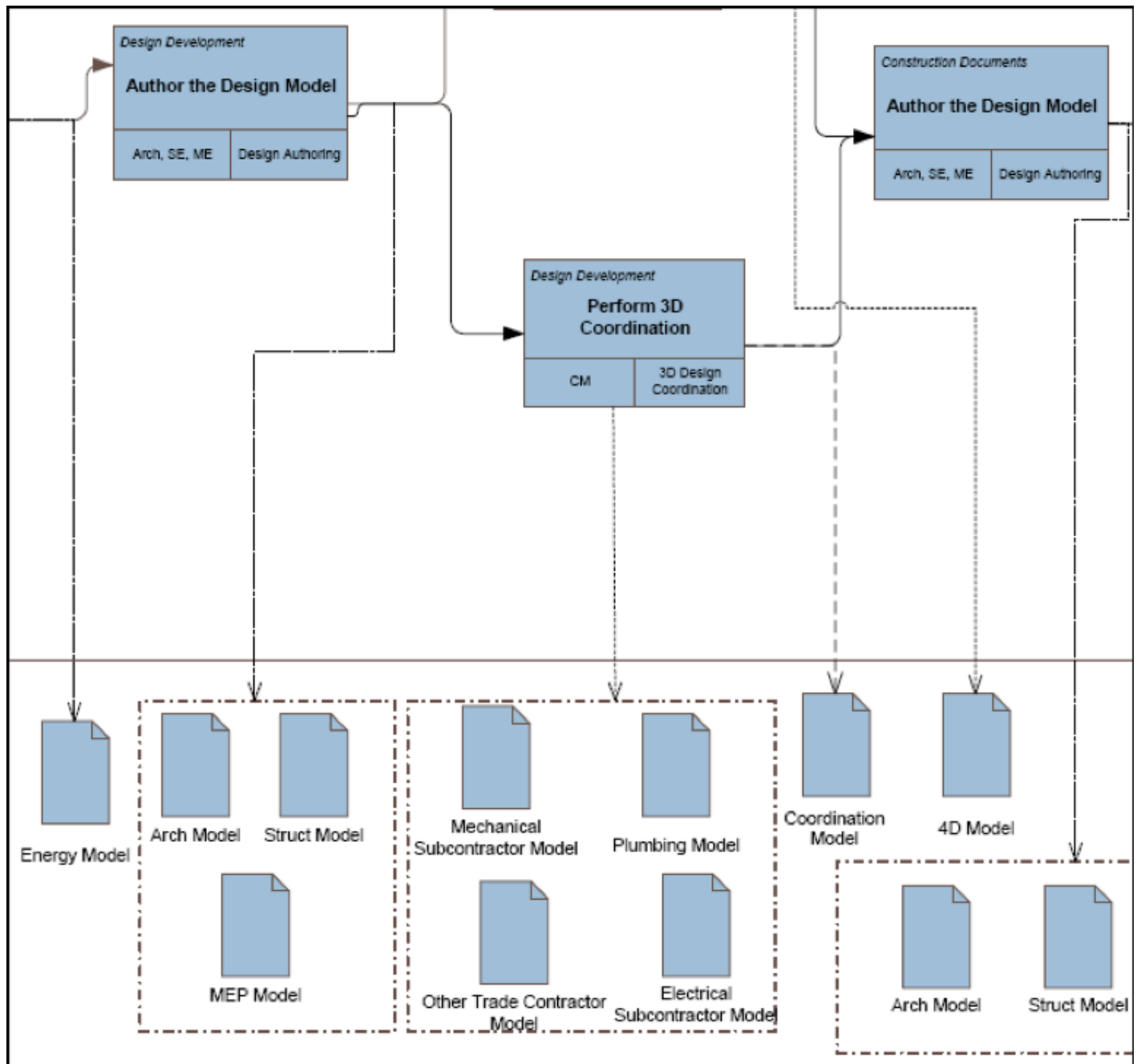

Figure 3.2: Portion of the BIM Overview Map for a Sample Laboratory Building Project

To illustrate the results of an overview mapping task, the BIM Overview Map for the Laboratory Project defines the overall BIM Uses that the team has employed for the project which are Design Authoring, Energy Analysis, 4D Modeling, 3D Design Coordination, and Record Modeling (reference Figure 3-3). It identifies that Energy Analysis is performed during the schematic design phase, whereas 4D Modeling and 3D Design Coordination are performed during design development and the construction document phases. The map also identifies the critical Information Exchanges that are shared between different parties.

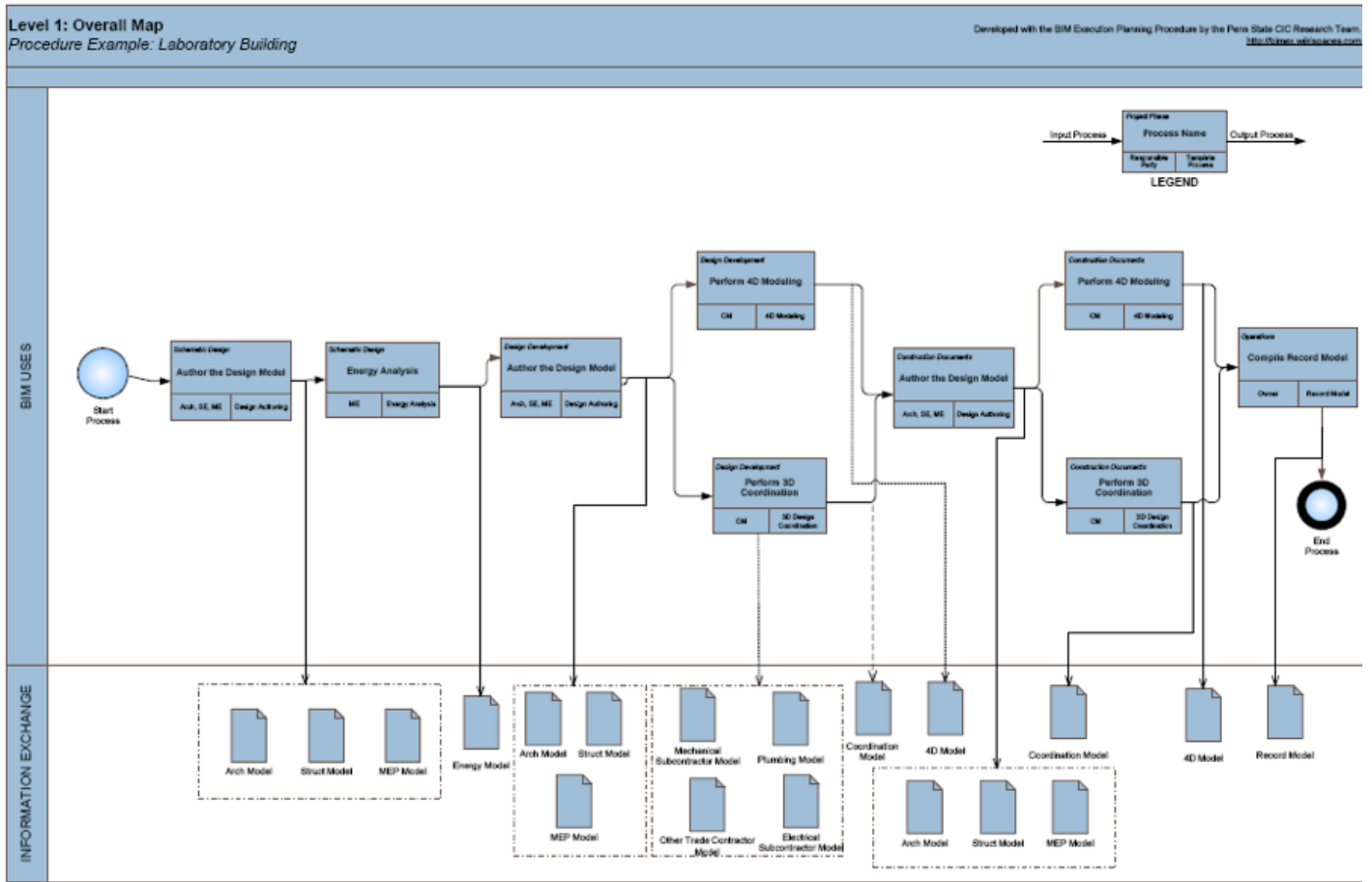

Figure 3.3: BIM Overview Map for a Sample Laboratory Building Project

Creating a Detailed BIM Use Map

After creating an Overview Map, a Detailed BIM Use Process Map must be created for each identified BIM Use to clearly define the sequence of the various processes performed within that Model Use. It is important to realize that each project and company is unique, so there may be many potential methods that a team could use to achieve a particular process. Therefore, these template process maps need to be customized by project teams to accomplish the project and organizational goals. For example, the template process map may need to be tailored to integrate a specific computer application workflow or project teamwork sequence.

A Detailed BIM Use Process Map includes three categories of information which are represented on the left side of the process map and the elements are included in the horizontal lines (referred to as 'lanes' in the BPMN mapping notation):

1. Reference Information: Structured information resources (enterprise and external) required to execute a BIM Use
2. Process: A logical sequence of activities that constitute a particular BIM Use
3. Information Exchange: The BIM deliverables from one process which may be required as a resource for future processes

To create a Detailed Process Map, a team should:

- 1) Hierarchically decompose the BIM Use into a set of processes

The core processes of the BIM Use need to be identified. These are represented by a 'rectangular box' symbol within BPMN. These are placed in sequential order within the Process swim lane.

- 2) Define the dependency between processes

Next, dependencies between the processes are defined. This is accomplished by defining the connections between processes. The project team needs to identify the predecessor and successor of each process. In some cases, it may be possible to have multiple successors and /or predecessors. These processes are then connected using the 'sequence flow' lines in BPMN.

3) Develop the Detailed Process Map with the following information

- a. Reference Information: Identify the informational resources needed to accomplish the BIM Use in the 'Reference Information' lane. Examples of reference information include cost databases, weather data, and product data.
- b. Information Exchanges: All the exchanges (internal and external) should be defined in the 'Information Exchange' lane. These exchanges are further detailed out in Chapter Four.
- c. Responsible Party: Identifies the responsible party for each process. Figure 3-4 displays how to represent this information in the process map.

4) Add Goal Verification Gateways at crucial decision points in the process

A gateway can be used to ensure that the deliverables or results of a process are met. It could also modify the process path based on a decision. Gateways provide the opportunity for the project team to represent any decisions, iterations or quality control checks required before the completion of a BIM task. Figure 3-4 demonstrates how this can be accomplished within a Detailed BIM Process Map (Level-Two Map).

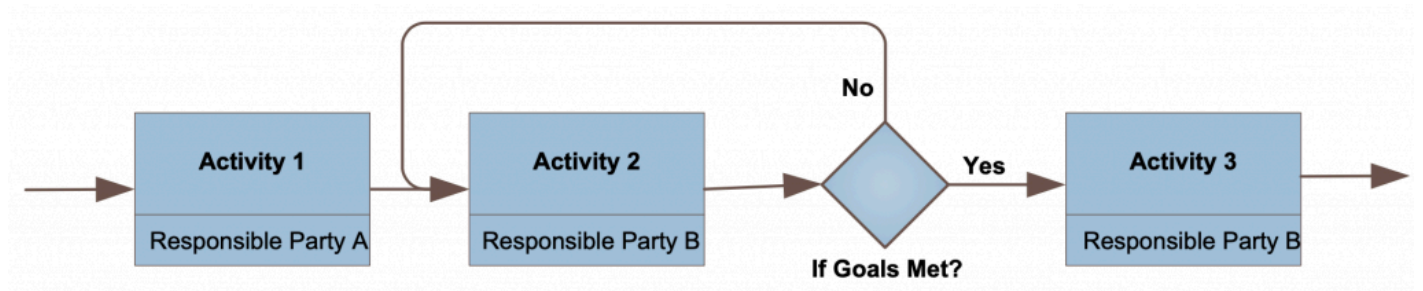

Figure 3.4: Example Goal Verification Gateway

5) Document, review and refine this process for further use

This Detailed Process Map can be further used for other projects by the project team. It should be saved and reviewed at various times throughout the BIM Implementation process. Throughout the project, detailed process maps should be updated periodically to reflect the actual workflows implemented on the project. Additionally, after project completion, it may be helpful to review the process maps to compare the actual process used versus the planned process. Detailed process maps can likely be used on future projects. Please reference Figure 3-5 for an example of a Detailed BIM Use Process Map.

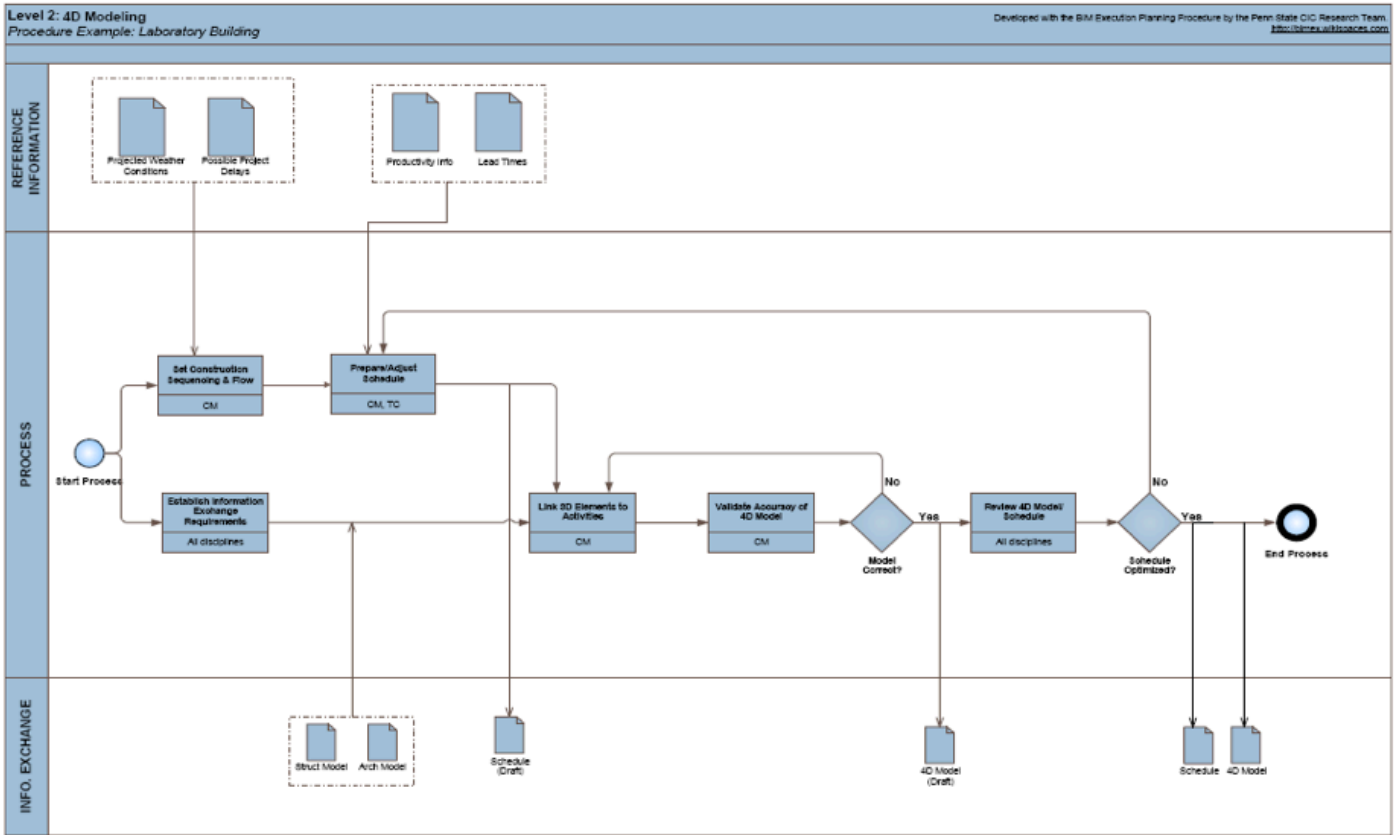





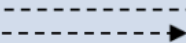
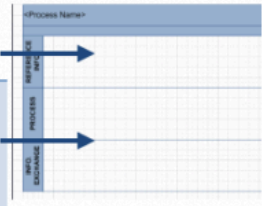

Figure 3.5: Detailed BIM Use Process Map for 4D Modeling

Symbols Used for Process Map Representation

For BIM Execution, the preferred notation for process mapping development is the Business Process Modeling Notation (BPMN) developed by the Management Group. One of the key elements of the BPMN is the visual appearance of the process map in terms of the symbols and markers used. These should conform to the shapes defined in BPMN specification.

The following symbols can be used to develop a Process Map for the BIM Plan:

Table 3.1: Process Mapping Notation for BIM Process Maps

Element	Description	Notation
Event	An Event is an occurrence in the course of a business process. Three types of Events exist, based on when they affect the flow: Start, Intermediate, and End.	
Process	A Process is represented by a rectangle and is a generic term for work or activity that entity performs.	
Gateway	A Gateway is used to control the divergence and convergence of Sequence Flow. A Gateway can also be seen as equivalent to a decision in conventional flowcharting.	
Sequence Flow	A Sequence Flow is used to show the order (predecessors and successors) that activities will be performed in a Process.	
Association	An Association is used to tie information and processes with Data Objects. An arrowhead on the Association indicates a direction of flow, when appropriate.	
Pool	A Pool acts as a graphical container for partitioning a set of activities from other Pools.	
Lane	A Lane is a sub-partition within a Pool and will extend the entire length of the Pool - either vertically or horizontally. Lanes are used to organize and categorize activities.	
Data Object	A Data Object is a mechanism to show how data is required or produced by activities. They are connected to the activities through Associations.	
Group	A group represents a category of information. This type of grouping does not affect the Sequence Flow of the activities within the group. The category name appears on the diagram as the group label. Groups can be used for documentation or analysis purposes.	

Define the Information Exchanges

The goal of this chapter is to present a method for defining information exchanges (identified in Chapter Three) between project processes that are crucial to successful BIM implementation. To define these exchanges, the team needs to understand what information is necessary to deliver each BIM Use. To assist in this task, an Information Exchange (IE) Worksheet was designed. The Information Exchange Worksheet should be completed in the early stages of a project after designing and mapping the BIM process. A blank graphical version of the IE Worksheet is available in [Appendix F](#) and a Microsoft Excel version is available at [Template – Information Exchange Worksheet V2-1 – MS Excel Format](#). The procedure for filling out the worksheet is described in Section Two of this chapter.

1. Pulling the Information Through the Project

Every element of a project does not need to be included for a model to be valuable. Therefore, it is important to only define the model components that are necessary to implement each BIM Use. Figure 4-1 depicts an example of how information flows through a BIM implementation process.

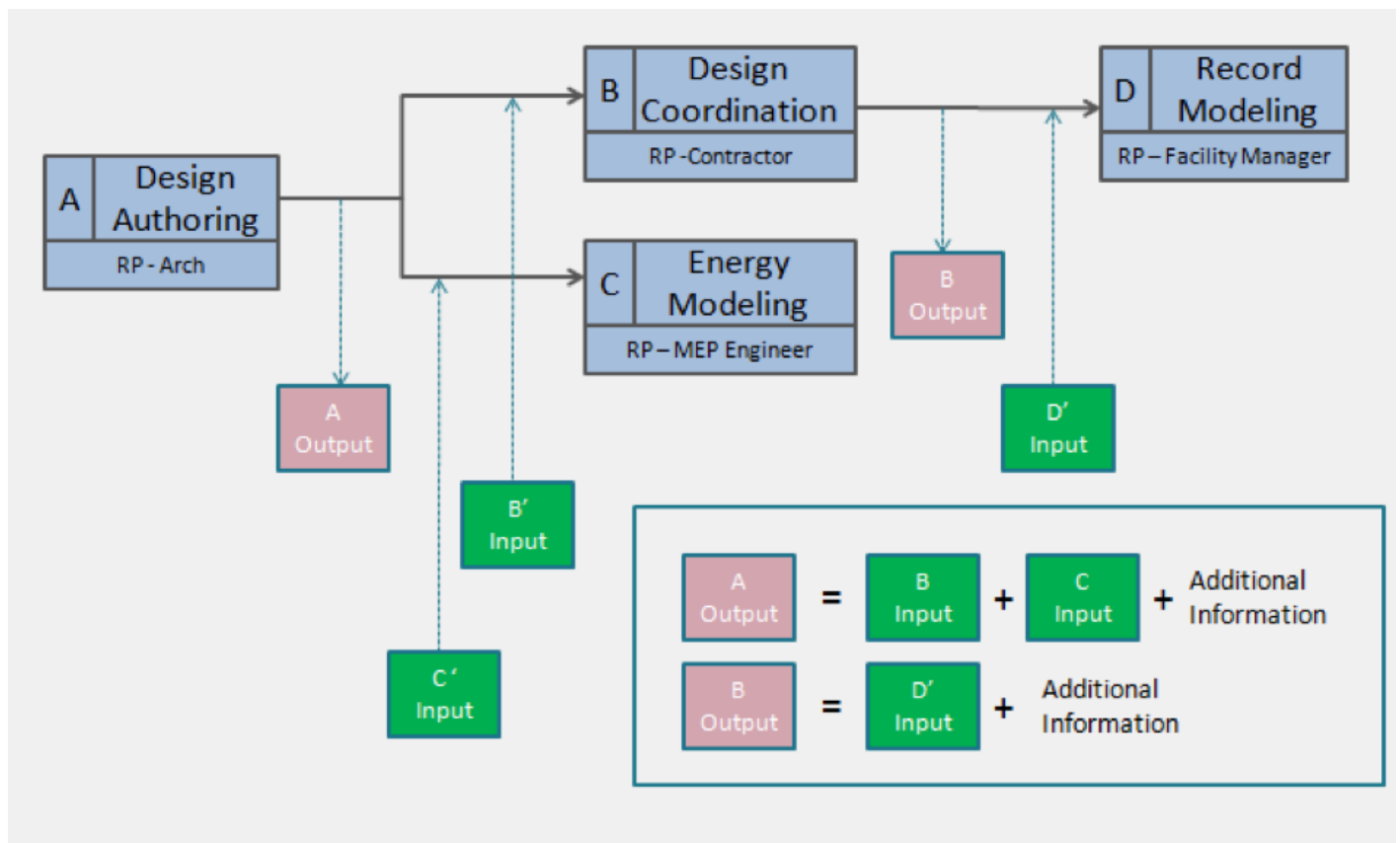

This figure was derived from the Level One process map described in Chapter Three. Note that downstream BIM Uses are directly affected by what is produced by the upstream Use. Looking at this example from the perspective of a pull-driven approach, if the model information required to implement a particular BIM Use is not authored by an upstream team member, then the information needed must be created by the responsible party of that Use. Therefore, it is up to the project team to decide who should be authoring this information and when this information needs to be placed into the BIM. For simplicity purposes, it is only necessary that the team define one information exchange requirement for each BIM Use; although, there may be several exchanges that take place. These exchanges should be clarified in the Level Two process maps depicted in [Chapter Three](#).

Information Exchange Worksheet

After process map development, information exchanges between project participants should be clearly identified. It is important for the team members and, in particular, the author and receiver of each information exchange transaction to clearly understand the information content. One procedure for creating the information exchange requirements is detailed below. It is important to note that there are several other standards or requirements that you can use to develop the information exchange definitions depending upon the project requirements, contracts or preferences of the team. One option is to perform a similar process as below, but use the [BIMForum Level of Development](#) spreadsheet to define each of the exchanges. Another option is to use the [US Army Corps of Engineers Minimum Modeling Matrix \(M3\)](#). While these tools vary in format and detail from the procedure below, they can all be used to define the level of development for each model exchanged within the process.

1) Identify each potential information exchange from the Level 1 Process Map

Information Exchanges that are shared between two parties should be defined. One BIM Use may have multiple exchanges; however, to simplify the process, only one exchange is necessary to document each Use. Also, the time of exchange should be derived from the Level One Map. This ensures that the involved parties know when the BIM deliverables are expected to be completed along with the project's schedule. The project phases should also be identified in the project-specific contract language (Chapter Five). When possible, the BIM Use exchanges should be listed in chronological order to give a visual representation of the progression of the model requirement.

2) Choose a Model Element Breakdown structure for the project

After the project team has established the Information Exchanges (IE), the team should select an element breakdown structure for the project. Currently, the IE Worksheet uses the CSI Unifomat II structure; however other options are available on the BIM Execution project website.

3) Identify the Information Requirements for each Exchange (Output & Input)

To define each information exchange, the following information should be documented:

- a. Model Receiver – Identify all project team members that will be receiving the information to perform a future BIM Use. These parties are responsible for filling out the Input Exchanges. Output exchanges will not have a model receiver and should be filled out by the project team, initiated by the Architect.
- b. Model File Type – List the specific software application(s), as well as, the version that will be used to manipulate the model during each BIM Use by the receiver. This is pertinent in order to identify any interoperability that may exist between exchanges.
- c. Information – Identify only the information necessary for the BIM Use implementation. Currently, the IE Worksheet uses a three-tier level of detail structure, shown in Table 4-1.

Table 4.1: Information Level of Detail

Information	
A	Accurate Size & Location, include materials and object parameters
B	General Size & Location, include parameter data
C	Schematic Size & Location

d. Notes – Not all necessary requirements for model content may be covered by the information and element breakdown structure, and if more description is needed, it should be added as a note. Notes can be specific to certain modeling content and/or depict a modeling technique.

4) Assign Responsible Parties to Author the Information Required

Each line item in an Information Exchange should have a party who is responsible for authoring the information. The responsibility for creating the information should lie with the party that can produce with the highest level of efficiency. Additionally, the time of input should be when it is needed by the model receiver, based on the level 1 process map. The worksheet can be sorted according to the responsible party to determine ones scope for each BIM deliverable. Table 4-2 below is a list of potential responsible parties.

Table 4.2: List of Potential Responsible Parties

Responsible Party	
ARCH	Architect
CON	Contractor
CE	Civil Engineer
FM	Facility Manager
MEP	MEP Engineer
SE	Structural Engineer
TC	Trade Contractors

5) Compare Input versus Output Content

Once the information requirements are defined, it is necessary for the project team to discuss the specific elements where the Output information (Authored) does not match the Input information (requested). The example in Figure 4-2 depicts an inconsistency between a Design Authoring Output Model and an Energy Analysis Input Model. When this occurs, two potential remedial actions need to take place:

1. Output Information Exchange Requirement –revise the information to a higher level of accuracy and/or include additional information (e.g. add R-Value to Exterior Walls); OR
2. Input Information Exchange Requirement –revise the responsible party so that information is authored by the organization performing the BIM Use

Information		Responsible Party	
A	Accurate Size & Location, include materials and object parameters	A	Architect
B	General Size & Location, include parameter data	C	Contractor
C	Schematic Size & Location	CV	Civil Engineer
		FM	Facility Manager
		MEP	MEP Engineer
		SE	Structural Engineer
		TC	Trade Contractors

Information Exchange Title		Design Authoring			3D Coordination			Energy Analysis		
		OUTPUT			INPUT			INPUT		
Time of Exchange (SD, DD, CD, Construction)					DD			DD		
Model Receiver		N/A			C, TC			MEP		
Receiver File Format										
Application & Version										
Model Element Breakdown		Info	Resp Party	Notes	Info	Resp Party	Notes	Info	Resp Party	Notes
B	SHELL									
	Superstructure									
	Floor Construction	B	A		B	A		B	A	
	Roof Construction	B	A		B	A		B	A	
	Exterior Enclosure									
	Exterior Walls	B	A		A	A		B	A	R Value
	Exterior Windows	B	A		B	A		A	A	Rvalue
	Exterior Doors	B	A					C	A	
	Roofing									
	Roof Coverings	B	A							
	Roof Openings	B	A		A	A		B	A	
C	INTERIORS									
	Interior Construction									
	Partitions	B	A		B	A		B	A	
	Interior Doors							C	A	
	Fittings	B	A		B	A			A	
	Stairs									
	Stair Construction	B	A		B	A		B	A	
	Stair Finishes									
	Interior Finishes									
	Wall Finishes							B	A	Reflectance
	Floor Finishes							B	A	Reflectance
	Ceiling Finishes							B	A	Reflectance
D	SERVICES									

Figure 4.2: Information Exchange Worksheet Example

- = Output Inadequacy (Revise Information) OR
- = Input Inadequacy (Revise Responsible Party)

Plan Infrastructure

The final step in the four-part BIM Project Execution Planning Procedure is to identify and define the project infrastructure required to effectively implement BIM as planned. Fourteen specific categories support the BIM project execution process. These categories, as displayed in Figure 5-1, were developed after analyzing the documents listed below, reviewing current execution plans, discussing the issues with industry experts and revised through extensive review by various industry organizations.

BIM Project Execution Plan

Categories

**BIM Project Execution Plan
Overview**

Project Information

Key Project Contacts

Project Goals / BIM Uses

Organizational Roles / Staffing

BIM Process Design

BIM Information Exchanges

BIM and Facility Data Requirements

Collaboration Procedures

Quality Control

Technological Infrastructure Needs

Model Structure

Project Deliverables

Figure 5.1: BIM Project Execution Plan Categories

This chapter describes each category of the BIM Project Execution Plan. Information for each category can vary significantly by project, therefore the goal of the description is to initiate discussion and address content areas and decisions which need to be made by the project team. Additionally, a template BIM Project Execution Plan has been developed and is available on the project website and referenced in [Appendix G – BIM Project Execution Plan Template](#). Please note that the information contained in the template will have to be customized based on the project. Additional information may be necessary, while other information could be removed.

1. BIM Project Execution Plan Overview

The final step in the four-part BIM Project Execution Planning Procedure is to identify and define the project infrastructure required to effectively implement BIM as planned. Fourteen specific categories support the BIM project execution process. These categories, as displayed in Figure 5-1, were developed after analyzing the documents listed below, reviewing current execution plans, discussing the issues with industry experts and revised through extensive review by various industry organizations.

Project Information

When developing the Project Execution Plan, the team should review and document critical project information that may be valuable for the BIM team for future reference. This section includes basic Project information that may be valuable for current and future. It can be used to help introduce new members to the project as well as help others reviewing the plan to understand the project. This section may include items such as project owner, project name, project location and address, contract type/delivery method, brief project description, project number(s) and the project schedule /phases/milestones. Figure 5-2 includes example project information items. Any additional general project information can and should be included in this section. Additional project information includes unique project characteristics, project budget, project requirements, contract status, funding status, and unique project requirements, etc.

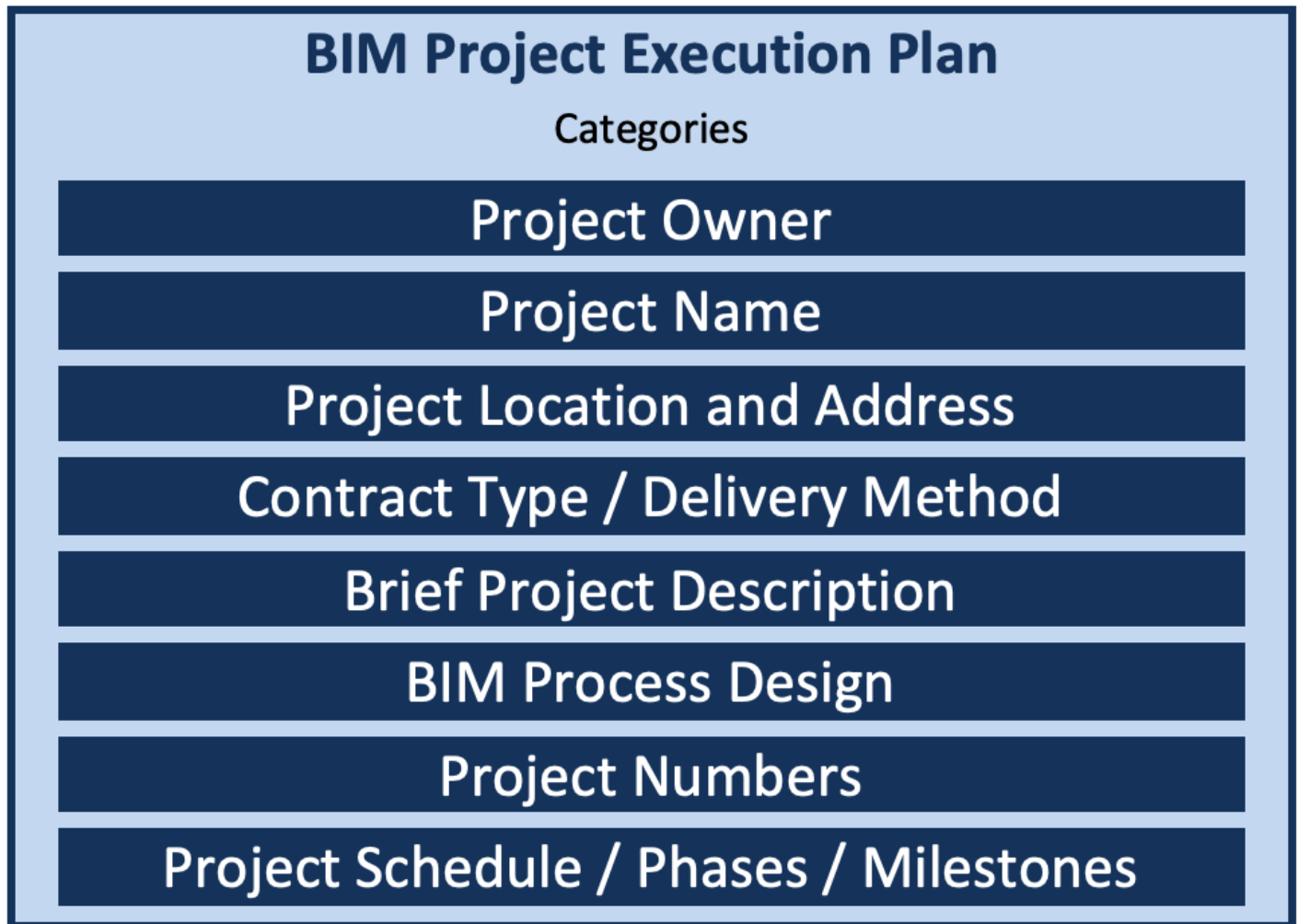

Figure 5.2: Diagram of Critical Project Overview Information

Key Project Contacts

At least one representative from each stakeholder involved should be identified including the owner, designers, consultants, prime contractors, subcontractors, manufacturers, and suppliers. These representatives could include personnel such as Project Managers, BIM Managers, Discipline Leads, Superintendents and other major project roles. All stakeholders' contact information should be collected, exchanged, and when convenient, posted on a shared collaborative project management web-portal.

Project BIM Goals / BIM Uses

The BIM Project Execution Plan should document the previous steps in the BIM project execution planning process. It is valuable for the team to document the underlying purpose for implementing BIM on the project as well as explain why key BIM Use decisions were made. The plan should include a clear list of the BIM goals, the BIM Use Analysis Worksheet, as well as specific information on the BIM Uses selected. The procedure to identify appropriate BIM Uses for a project is outlined in detail in [Chapter 2: Identifying BIM Goals and BIM Uses](#).

Organizational Roles and Staffing

The roles in each organization and their specific responsibilities must be defined. For each BIM Use selected, the team must identify which organization(s) will staff and perform that use. This includes the number of personnel by job title necessary to complete the BIM Use, the estimated worker hours, the primary location that will complete the Use and the Lead organizational contact for that Use. Depending on which phase of a project's lifecycle this

plan is completed several items in this section may be challenging to complete. Like the rest of the Plan, as much as possible should be completed and the remaining should be completed as the information becomes available.

BIM Process Design

The process maps created for each selected BIM Use in step two of the BIM Project Execution Planning Process should be documented in the Plan. These process maps provide a detailed plan for implementation of each BIM Use. They also define the specific information exchanges for each activity, building the foundation for the entire execution plan. The plan should include the overview map of the BIM Uses, a detailed map of each BIM Use, and a description of elements on each map. For further explanation of the steps to create process maps, please refer to Chapter 3: Designing the BIM Project Execution Process.

BIM Information Exchanges

The team should document the information exchanges created as part of the planning process in the BIM Project Execution Plan. The information exchanges will illustrate the model elements by discipline, level of detail, and any specific attributes important to the project. The project models do not need to include every element of the project, but it is important for the team to define the model components and discipline-specific deliverables to maximize value and limit unnecessary modeling on the project. For further explanation of the steps to create information exchanges, please refer to [Chapter 4: Developing Information Exchanges](#).

BIM and Facility Data Requirements

Some project owners have very specific BIM requirements. It is important for the plan to document the BIM requirements in the native format from the owner. This way the team is aware of the requirements and can plan accordingly to deliver those requirements.

Collaboration Procedures

The team must develop their electronic and activity collaboration procedures. This includes model management (e.g., model check-out, revision procedures, etc.), and standard meeting actions and agendas.

Collaboration Strategy

The team should document how the project team will collaborate in general. When planning, consider items such as communication methods, document management and transfer, and record storage, etc.

Collaboration Activity Procedures

Specific collaboration activities should be defined, which may include:

1. Identify all collaborative activities that support or are supported by BIM
2. Determine which project stage or phase that activity will take place
3. Determine the appropriate frequency for that activity
4. Determine the participants necessary to conduct that activity properly
5. Determine the location for that activity to take place

Model Delivery Schedule of Information Exchange for Submission and Approval

Determine the schedule for information exchange between parties. Information exchanges should be analyzed in earlier steps; however, it is helpful to document them all in one place. Information that should be considered includes:

1. Information Exchange Name (should be drawn from step 3 of the planning process)
2. Information Exchange Sender
3. Information Exchange Receiver
4. One-Time or Frequency (is this a one – time or periodic exchange? If periodic, how often?)
5. Start and due dates
6. Model file type
7. Software used to create the file
8. Native file type
9. File exchange types (receiver file type)

Interactive Workspace

The project team should consider the physical environment it will need throughout the lifecycle of the project to accommodate the necessary collaboration, communication, and reviews that will improve the BIM Plan decision-making process. Describe how the project team will be located. Consider questions like “will the team be collocated?” If so, where is the location and what will be in that space? Will there be a BIM Trailer? If yes, where will it be located and what will be in the space such as computers, projectors, tables, table configuration? Include any necessary information about workspaces on the project.

Electronic Communication Procedures

Establish communication protocol with all project team members. Electronic communication with stakeholders can be created, uploaded, sent out and archived through a collaborative project management system. Save copies of all project related communication for safekeeping and future reference. Document management (file folder structure, permissions and access, folder maintenance, folder notifications, and file naming convention) should also be resolved and defined.

Quality Control

Project teams should determine and document their overall strategy for quality control of the model. To ensure model quality in every project phase and before information exchanges, procedures must be defined and implemented. Each BIM created during the lifecycle of the project must be pre-planned considering model content, level of detail, format, and party responsible for updates; and distribution of the model and data to various parties. Each party contributing to the BIM model should have a responsible person to coordinate the model. This person, as part of the BIM team, should participate in all major BIM activities as required by the team. They should be responsible for addressing issues that might arise with keeping the model and data updated, accurate, and comprehensive.

Quality control of deliverables must to be accomplished at each major BIM activity such as design reviews, coordination meetings or milestones. The standard of data quality should be established in the planning process and agreed upon by the team. Standards such as AEC CADD and National Building Information Model Standards may be appropriate for the team to consider. If a deliverable does not meet the team’s standards, the reason why the deliverable is lacking should be further investigated and prevented in the future. The deliverable needs to comply with standards required by the owner and agreed upon by the project team.

Quality Control Checks

Each project team member should be responsible for performing quality control checks of their design, dataset and model properties before submitting their deliverables. Documentation confirming that a quality check was performed can be part of each submittal or BIM report. The BIM Manager should be the one to confirm quality of the model after the revisions were made.

The following quality control checks should be considered when determining a plan for quality control:

- Visual Check: Ensure there are no unintended model components and the design intent has been followed by using navigation software
- Interference Check: Detect problems in the model where two building components are clashing by a Conflict Detection software
- Standards Check: Ensure that the model is to the standards agreed upon by the team.
- Element Validation: Ensure that the dataset has no undefined or incorrectly defined elements

Each party should designate a responsible party to make sure that the agreed-upon process for quality control of models and data has been followed before accepting submittals and model revisions.

Technology Infrastructure Needs

The team should determine the requirements for hardware, software platforms, software licenses, networks, and modeling content for the project.

Software

Teams and organizations need to determine which software platforms and version of that software is necessary to perform the BIM Uses that were selected during the planning process. It is important to agree upon a software platform early in the project to help remedy possible interoperability issues. File formats for information transfer should have already been agreed upon during the information exchange planning step. Additionally, the team should agree upon a process for changing or upgrading software platforms and versions, so that a party does not create an issue where a model is no longer interoperable with other parties.

Computers / Hardware

Understanding hardware specifications becomes valuable once information begins to be shared between several disciplines or organizations. It also becomes valuable to ensure that the downstream hardware is not less powerful than the hardware used to create the information. In order to ensure that this does not happen, choose the hardware that is in the highest demand and most appropriate for the majority of BIM Uses.

Modeling Content and Reference Information

The project and reference information, such as Modeling families, workspaces, and databases, must be considered to ensure that the project parties will use consistent standards.

Model Structure

The team must identify the methods to ensure model accuracy and comprehensiveness. After agreeing on collaboration procedures and technology infrastructure needs, the planning team should reach consensus on how the model is created, organized, communicated and controlled. Items to consider include:

- Defining a file naming structure for all designers, contractor, subcontractors, and other project members
- Describing and diagram how the models will be separated (e.g. by building, by floors, by zones, by areas, and/or by disciplines)
- Describing the measurement system (imperial or metric) and coordinate system (geo-referenced / origin point) to be used to allow for easier model integration.
- Identifying and agreeing upon items such as the BIM and CAD standards, content reference information, and the version of IFC, etc.

Project Deliverables

The project team should consider what deliverables are required by the project owner. With the deliverable project phase, due date format and any other specific information about the deliverable should be considered.

Delivery Strategy / Contract

When implementing BIM on a project, attention should be paid to the delivery method and contraction methods before the project begins. Ideally, a more integrated approach such as design-build or Integrated Project Delivery (IPD) would be used. While it usually yields the best results for the project, an integrated approach is not always possible on all projects. This could be because of a number of reasons. Additionally, the contract type and delivery method may have already been selected before BIM planning takes place. If this is the case the team needs to consider future subcontractors and consultants and also consider what steps are necessary to ensure successful BIM implementation no matter what the delivery method. BIM can be implemented successfully within all delivery methods.

Definition of Project Delivery Approach

If the project contract type or delivery method have not yet been determined, it is important to consider how they will affect the implementation of BIM on the project. All delivery methods can benefit from the use of BIM; however, core concepts are more easily implemented with higher levels of integration in the project delivery process. When planning the impact of BIM on the delivery approach, the planning team should consider the four main decisions:

- Organizational Structure and Typical Delivery Method
- Procurement Method

- Payment Method
- Work Breakdown Structure

Consider BIM requirements when selecting the delivery approach and when drafting contracts. Integrated Project Delivery (IPD) and Design-Build are highly collaborative delivery methods that facilitate information sharing based on the risk and reward structure, and several new contract forms were recently released to address BIM, delivery structure and contracting.

If you do not plan to use IPD or Design-Build on a project or the delivery method has already been selected, BIM can still successfully be implemented with other delivery structures, such as Design-Bid-Build or CM at Risk. When using a less integrated delivery structure, it is important to work through an initial BIM Execution Process and then assign roles and responsibilities in the contract structure. It is also important that there is buy-in from all the team members so that all parts can have as much success as possible. Without buy-in from all members, it will decrease the quality of the BIM product, lead to added work by other project members and could result, at worst, an unsuccessful implementation of BIM on that project.

Team Selection Procedure

The planning team needs to consider the criteria and procedure for the selection of future project team members based on their organization's BIM ability. When creating the criteria, the team needs to review the competencies for each BIM Use selected during the planning process. After the required competencies are determined, project teams should require the new project members to display that they have those competencies through examples of prior work or demonstrations. It is critical that all team members have the ability to perform their BIM responsibilities.

BIM Contractual Language

Integrating BIM on a project not only improves particular processes but also increases the degree of project collaboration. Collaboration is of particular importance when the contract affects the degree of change in the project delivery process and provides some control over potential liability issues. The owner and team members should pay careful attention to the drafting of BIM contractual requirements since they will guide the participant's actions.

The following areas should be considered and included in contracts where applicable:

- Model development and responsibilities of parties involved (Chapter Four)
- Model sharing and Model reliability
- Interoperability / file format
- Model management
- Intellectual property rights
- The requirement for BIM Project Execution Planning

Standard contracts may be used on BIM projects, but edit the contents to include the necessary items mentioned. There are several contract addendums or modified contract forms that address BIM implementation on a project (see below). A written BIM Project Execution Plan should be specifically referenced and required within the developed contracts for the project so that team members participate in the planning and implementation process.

BIM requirements should also be incorporated into consultant, subcontractor and vendor agreements. For example, the team may require each subcontractor to model the scope of work for 3D design coordination, or they may wish to receive models and data from the vendors for incorporation into the coordination or record models. Modeling initiatives required by consultants, subcontractors, and vendors must be clearly defined within the contracts including the scope, schedule for delivery of the model, and file/data formats. By having the BIM requirements in the contract, team members are legally required to complete implementation as planned. If BIM was not written into contracts, additional steps are required to ensure that the BIM Plan is followed by all project participants.

Implementing the BIM Project Execution Planning Procedure

The development of the BIM Plan is a collaborative process. Some portions of the procedure, e.g., discussing the overall project goals, are collaborative tasks, while other portions, e.g., defining the required file structure or detailed information exchange, do not necessarily require collaboration. The key to successfully developing the plan is to ensure that meetings are scheduled for the collaborative tasks when needed, and that the non-collaborative tasks are completed in a timely manner, in preparation for these meetings. The BIM Plan can be developed through a series of collaborative meetings, followed by work tasks which take place between the meetings. A series of four meetings have been defined to develop the BIM Plan. The goal of presenting the four meeting series is to illustrate one structure that the team can use to effectively develop the plan. For some projects, the team may be able to reduce the number of meetings through effective collaboration between meetings.

Meeting Structure for Developing a BIM Project Execution Plan

The four meetings proposed to develop the BIM Project Execution Plan are closely aligned with the primary steps outlined in Chapter One. The meetings and interim tasks include:

Meeting 1: Identify BIM Goals and Uses

The first meeting should focus on the discussion of the overall goals for implementing BIM, along with identifying the BIM Uses. A draft agenda for this meeting would include:

1. Introduce and Discuss BIM Experiences (both individual and organizational)
2. Develop BIM goals (reference BIM Goal template document)
3. Identify which BIM Uses to pursue (reference the BIM Uses worksheet)
4. Develop the frequency and sequencing for the BIM Uses and identify a responsible party to develop a high level (Level One) BIM Overview process map
5. Identify the responsible parties to develop detailed BIM Use process maps, e.g., the level two maps
6. Organize the schedule for future meetings
7. Agree on the tasks ahead and who is responsible for each

This meeting should be attended by senior management personnel and BIM management staff for all involved participants including the owner, designers, contractors, and key subcontractors.

Tasks Prior to Meeting 2

After the initial kick-off meeting, the organizations should clearly understand who will be responsible for the defined tasks, and in what sequences the BIM Uses will be executed. The responsible party for the Level One

map should clearly document and distribute it to the project team for review prior to the following meeting. Each responsible party for the specified BIM Uses should also draft their workflow prior to the Design BIM Project Execution Process meeting (Meeting 2).

Meeting 2: Design BIM Project Execution Process

The Project Specific BIM Use Process Maps shall contain a detailed process plan that clearly defines the different activities to be performed, who will perform them, and what information will be created and shared with future processes. The agenda for this meeting will include:

1. Review the initial BIM Goals and Uses
2. Review the high-level BIM Overview Process Map
3. Review the more detailed workflows from the various parties and identify areas of overlap or gaps between the various modeling tasks
4. Review the process to address opportunities and concerns
5. Identify the primary information exchanges within the process
6. Identify responsible parties for coordinating each information exchange including the author and user of each exchange
7. Allow sub-teams for each information exchange to coordinate potential interim meetings as needed to discuss the information exchange requirements
8. Agree on the tasks ahead and who is responsible for each

This meeting should be attended by the owner, BIM managers and project manager for the project. It may also be valuable to have contracting managers in attendance or have them briefed soon after this meeting.

Tasks Prior to Meeting 3

After the Design BIM Project Execution Process meeting, the team must focus on developing the information exchanges. Each responsible party for an exchange should take the lead in developing the information exchanges. The authors of the information exchange will need to coordinate with the information receivers to ensure that they have developed consistent information exchanges with minimal inconsistencies to discuss at Meeting Three. The team members should also prepare for the discussions regarding infrastructure requirements which will occur in Meeting Three. Team members should compile examples of typical methods that they have used or wish to use on the project to share with the team.

Meeting 3: Develop Information Exchanges and Define Supporting Infrastructure for BIM Implementation

The agenda for this meeting will include:

1. Review the initial BIM Goals and BIM Uses to ensure that the project planning remains consistent with the initial goals
2. Review the information exchange requirements developed by the team members between Meeting Two and Meeting Three
3. Identify the infrastructure needed to support the process and information exchanges as defined in Chapter Five
4. Agree on tasks ahead and who is responsible for each

This meeting should be attended by the BIM managers. It may also be valuable to have contracting managers in attendance or briefed soon after this meeting.

Tasks Prior to Meeting 4

The categories and information should be compiled into the final BIM Execution Plan format and distributed to the project team in preparation for the final plan review meeting.

Meeting 4: Review Final BIM Project Execution Plan

The agenda for this meeting will include:

1. Review the draft BIM Project Execution Plan
2. Develop the project controls system to ensure that the plan is being followed, and that the plan is up to date
3. Outline the procedure for formal adoption of the BIM Project Execution Plan and monitoring process
4. Agree on tasks ahead and who is responsible for each

This meeting should be attended by the owner, BIM managers, and all parties that are responsible for the identified BIM Uses.

Tasks after Meeting 4

Once the meetings are complete, the BIM Project Execution Plan should be distributed to all parties and approved as appropriate for the project and contracting structure. Team members should ensure that the plan monitoring and updating procedure is implemented into the project controls system.

Planning Meeting Schedule

One of the first tasks of the team is to determine the planning meeting schedule. This schedule should identify the defined meetings, along with the scheduled dates for the meeting. The team may decide that they wish to spread the planning procedure across several weeks with one of the defined meetings each week or every other week. But they also may wish to define an accelerated planning schedule over several days with the team specifically focused on the development of the plan.

Monitoring Progress against the BIM Execution Plan

Once the initial BIM Execution Plan is created, it will need to be continuously communicated, monitored and updated throughout the project. In particular, the Project Execution Plan should be embedded into appropriate contracts, and then updated as needed when new team members join the project team. At a minimum, it is valuable for the BIM managers from the various team members to meet on a monthly basis to discuss the progress of the information modeling initiatives on the project and to address any implementation challenges that team members may be encountering. These meetings may be incorporated with other team meetings, but it is important to specifically address issues that may arise in the implementation of the plan. It is important for the team to continuously modify the planned process as needed due to the addition of team members, revisions to available technology, changes to the overall project conditions, and to reflect the actual process that evolved. The team should agree to a formal plan for accepting updates to the plan, and then accurately document any changes to the original plan for communication to other team members, as well as for accurate future use and reference.

BIM Project Execution Planning for Organizations

As stated in the introduction, BIM Plans require typical methods developed by each organization involved. The purpose of this chapter is to define how organizations can use the BIM Project Execution Planning procedure to develop these typical methods for BIM project implementation. Figure 7.1 revisits the BIM planning concept to show how organizational means and methods play a vital role in the implementation process. To obtain the greatest benefit from BIM, the organizations must be willing to develop and share this information with the project team.

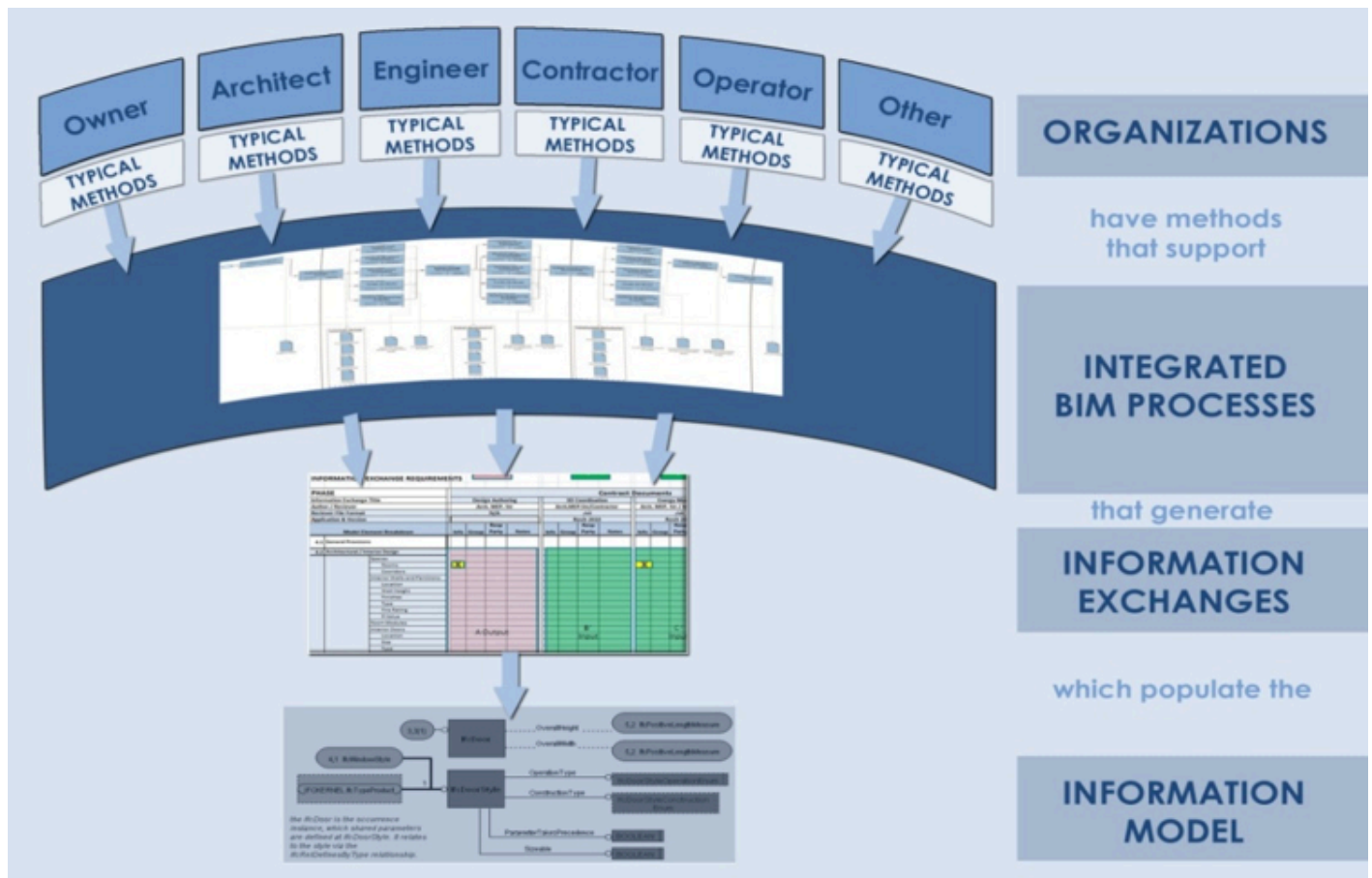

Figure 7.1: BIM Project Execution Planning Concept

Organizations should develop internal standards defining how they intend to use BIM as on an organizational level. By completing the planning process as an organization prior to the BIM Plan for an individual project,

each stakeholder will have a starting point for planning and be able to modify existing organizational standards rather than creating entirely new processes. Additionally, these standards can be shared within the organization to help communicate typical means and methods. Using a similar four-step procedure with minor modifications, organizations can create BIM Project Execution Planning standards to be used on future projects.

1. BIM Mission Statement and Goals

The organization should establish a BIM mission statement. When creating the mission statement, consider why BIM is important to the organization and the reasons for using BIM such as gaining a competitive advantage on proposals, increasing productivity, improving design quality, reacting to industry demand, satisfying owner requirements, or improving innovation. Developing a clear mission statement sets the stage for future organizational decisions related to BIM.

After a mission statement is established, the planning team should develop a list of standard project goals that would be beneficial to the organization and typical projects. The list can be divided into several categories such as required, recommended, and optional for each project type. The goals created should be modifiable based on individual project and team characteristics. Defining standard goals will allow each project team to select from a “menu” of potential goals which will ensure a more comprehensive list of goals along with reducing the time to develop the goals.

BIM Uses

An organization should define typical BIM Uses for future projects that align with the goals established within the organization. Some Uses should be required for every project, while others can only be suggested or optional based on team and project characteristics. Standard BIM Uses can be determined using the tools for project execution planning such as the BIM Use Analysis Worksheet. Using this worksheet, the planning teams can assess the current BIM competencies which the organization possesses and the additional competencies required for each use. When determining which BIM Uses should be required or suggested, it is important to recognize which BIM Uses build upon each other. If an organization controls multiple processes in a value stream, there will be potential benefits in implementing uses across the multiple processes. It is also critical that the planning team is not overambitious about which BIM Uses are required and ensure that the selected BIM Uses are realistic for project teams to accomplish. By determining which BIM Uses will be selected for each project, it will increase the chance of those uses being completed and will also allow the organization to properly evaluate which uses are most beneficial.

BIM Process Maps

Standard BIM Process Maps should be created to demonstrate the organization’s BIM process(es) to project team members internally and externally. While the creation of a generic Overview (Level One) Process Map may be beneficial to the project team, this will vary greatly from project to project (depending on which Uses are selected). Therefore, it is more valuable for organizations to devote time to the Detailed (Level Two) Process Maps. Multiple process maps may be required for each BIM Use depending upon the software, level of detail, contract type, delivery method, and project type. Additionally, it may be helpful to create instructions and specifications for each process map generated. Each project team will then take the level two process maps and customize them based on the project’s and the team’s needs.

BIM Information Exchanges

The organizational planning team should establish standard information exchanges for each BIM Use which they perform. The planning team should identify the information needed for each use; the person who is typically responsible for generating this information; and the preferred format for the information exchange. It may also be necessary to create multiple information exchanges for each use based on different conditions such as software platform, level of detail, and project complexity. A typical model element breakdown should also be selected and standardized across the organization when practical. Understanding the information requirements for each BIM Use will greatly streamline the planning needed for each project and the information exchange step in the Project

Execution Planning Procedure will simply focus on finding inconsistency in the data that will be generated by one organization and needed by another.

BIM Infrastructure

When planning organizational standards for BIM Project Execution Planning, it is important to consider all the resources and infrastructure required to perform the selected processes. For each BIM Use selected, the planning team should determine the personnel who will perform each use; establish a plan for adapting each BIM Use's personnel based on project size, complexity, level of detail and scope; and determine which personnel will typically oversee the BIM Use.

The organization should design standard collaboration procedures. Included in this task is crafting standard strategies based on different project types and delivery methods. The planning team should also determine standard collaboration activities and meetings that will take place on typical projects including frequency and required attendees. It is also essential that the organization establishes standard electronic communication procedures. Specific items that should be addressed include file storage and backup systems; standard file folder structures; standard file naming conventions; standard content libraries; and standards for sharing of information both externally and internally.

Along with collaboration procedures, information management quality assurance and control is valuable for every project. The quality of a model can significantly impact a project; therefore the organization should have standard quality control processes that are well documented and allow for easy implementation to ensure the level of quality required for each modeling use.

The planning team should assess the software and hardware needs of each BIM Use and compare the technical infrastructure needs to the current software and hardware. Necessary upgrades and purchases should be made to ensure that the software and hardware does not limit the successful modeling performance. If the proper equipment is not in place, it could result in lower productivity and increased time and cost for each BIM Use.

Typical project deliverables need to be established based on different project characteristics. Project Owners should establish a list of deliverables for each project based on all the information generated during the planning process. Designers and contractors should also create a "menu" of BIM services that add value to the overall project.

It is valuable to consider how BIM will be incorporated into both prime contracts and subcontracts. Requirements for BIM, including BIM Project Execution Planning, BIM Uses, and information exchanges, should be written into contracts. The planning team should develop draft language that can be incorporated into contracts, along with developing procedures for a team which will allow the organization to identify appropriate team members.

Developing the BIM Project Execution Plan

By performing organizational level planning, the team can reduce the amount of time spent on each step of the planning process and maintain a manageable planning scope by defining their standard goals, uses, processes, and information exchanges. The BIM Project Execution Planning Procedure requires organizations to provide information regarding their standard practices, including information exchanges. While certain contract structures can lead to collaboration challenges, the goal of this procedure is to have the team develop a BIM process containing deliverables that will be beneficial to all members involved. To reach this goal, the project team needs to have open lines of communication. To be successful, the team members must buy into the process and be willing to share this intellectual content with other team members.

Conclusions and Recommendations

This guide outlines a structured, four-step BIM Project Execution Planning Procedure, along with appropriate implementation guidelines. The implementation of this procedure has been performed on seven projects and within three organizations. By analyzing the successes and challenges encountered within these implementation case studies, the following ten recommendations for successful implementation were identified.

1) **Each project team needs a BIM Champion.** A project using the BIM Project Execution Planning Procedure is more likely to succeed when there is at least one person with a strong desire to develop the BIM Plan. These champions take time to learn the procedure and work to help compile the final BIM Plan. They also market the value and necessity of the process to the other project team members. It is important that the champion(s) on a project encourages the team to take the time to plan the work, even if there is strong schedule pressure to begin developing model content prior to the completion of the planning process. The BIM champion could be from any primary organization, or even a third party, but within the case study projects, these champions were primarily from the owner or construction manager organization.

2) **Owner involvement is critical throughout the entire process.** By providing the guidelines for model and information deliverables, the owner can emphasize the importance of BIM implementation for reaching their desired end goals for the facility. Owner involvement and enthusiasm regarding the process can encourage project team members to seek the best processes that will benefit the entire project. Owners should consider writing a BIM Project Execution Plan into their contract documents to ensure that the planning process is performed to a level of detail which meets their expectations.

3) **It is essential that the project team fosters an open environment of sharing and collaboration.** The BIM Project Execution Planning Procedure requires organizations to provide information regarding their standard practices, including information exchange requirements. While certain contract structures can lead to collaboration challenges, the goal of this procedure is to have the team develop a BIM process containing deliverables that will be beneficial to all members involved. To achieve this goal, the project team should have open lines of communication. The team members must buy-in to the process and be willing to share their intellectual content with other team members.

4) **The BIM Project Execution Planning Procedure can be adapted to different contracting structures.** The BIM process has the ability to be more comprehensively adopted in more integrated project delivery approaches. However, none of the case studies used to validate the procedure were used with a specific Integrated Project Delivery (IPD) contract. The core steps of the procedure are helpful no matter which delivery method is used, but there are added challenges when implementing the planning when all core team members are not involved in the early stages of the project.. Depending on the contract strategy, additional steps may be needed to ensure project planning success, and early assumptions may be needed to plan for future team members.

5) **There is great value in early planning.** If planning does not take place early, extra time may be needed to

resolve inconsistencies downstream. This often results in more time and resources used than the original planning would have needed.

6) **The BIM Plan should be treated as a living document.** When beginning the BIM Project Execution Planning Procedure, it is valuable to understand that the BIM Plan will be need to be flexible and the plan should be reviewed and updated on a periodic basis. It is unrealistic to assume that the project team will have all information necessary to avoid assumptions that may need to be made to develop the BIM Plan at the inception of the project. It will take time to populate the information because additional and new information must be incorporated as project team members are added.

7) **Once an initial plan is developed, it must be reviewed regularly.** A revision schedule should be set based on a frequency that the project team deems appropriate. Throughout the life of the project, it is important to keep the initial project goals in mind to ensure that the team is working towards their completion. If there is any deviation, reassessment of or rededication to the original goals should occur.

8) **The appropriate resources must be made available to ensure planning success.** It is important to keep in mind that the level of effort needed for this process should not be underestimated. Project teams must consider the time allocated for planning when generating both the project schedule and project budget. Due to the learning curve associated with this process, teams should overestimate the time it will take to produce a BIM Project Execution Plan. The time associated with the learning curve can be reduced by educating involved team members before delving into the process. Without proper planning before the project specific meetings begin, many unexpected issues may arise that could have been solved at an earlier time.

9) **Developing an organizational BIM Project Execution Plan before project inception can decrease project planning time.** By performing organizational level planning, the team can reduce the amount of time spent on each step of the planning process and maintain a manageable planning scope by defining their standard goals, uses, processes, and information exchanges. You may wish to reference the BIM Planning Guide for Facility Owners, available at <http://bim.psu.edu>, for additional information related to BIM planning at an organizational level.

10) **The BIM Project Execution Planning Procedure can be adapted for multiple uses and situations beyond the original scope of the project.** Even if project teams take only what they need from the procedure and do not complete the entire process, these projects can still create detailed BIM Plans. Teams have the ability to revise the template documents to fit their specific processes, without modifying any of the core steps of the planning procedure. These teams then have the ability to eventually add other portions of the procedure, which will further assist with their planning.

The BIM Project Execution Planning Procedure has helped project teams develop detailed plans for their projects. These plans outline the goals, process, information exchanges, and infrastructure for BIM implementation. By developing and following these plans, the teams are able to make a significant impact on the degree of successful BIM implementation. The procedure does take time and resources, particularly the first time an organization is involved in this level of planning, but the benefits of developing the detailed plan far outweigh the resources expended.

Appendix A: BIM Goals Worksheet

The following BIM Goals and Uses worksheet is available for download at [Goals and Model Use Analysis Worksheet – Version 3-0](#). See [Chapter 2](#) for guidance regarding the development of project goals and potential BIM uses to support the goals.

Project Goals

Priority	Project Goal	Potential BIM Uses
1 = Most Important		

Figure A.1: Project Goals Template

Appendix B: Model Use Descriptions

See [Chapter 3](#) for guidance regarding the selection of potential Model Uses. The following is a list of revised Model Use for Version 3.0 presented from the operations through the planning phase per [Figure 2-3](#):

1. [Monitor System Performance](#)
2. [Monitor Space Utilization](#)
3. [Monitor Assets](#)
4. [Monitor Maintenance](#)
5. [Compile Record Model](#)
6. [Layout Construction Work](#)
7. [Fabricate Products](#)
8. [Author Temporary Construction Systems Model](#)
9. [Author Construction Site Logistics Model](#)
10. [Draw Construction Documents](#)
11. [Analyze Sustainability Performance](#)
12. [Review Design Model\(s\)](#)
13. [Coordinate Design Models](#)
14. [Analyze Lighting Performance](#)
15. [Analyze Structural Performance](#)
16. [Analyze Energy Performance](#)
17. [Author 4D Model](#)
18. [Author Cost Estimate](#)
19. [Analyze Program Requirements](#)
20. [Author Design Model](#)
21. [Capture Existing Conditions](#)

There are several additional model uses that are also included in Appendix B as additional potential model uses:

- [Site Analysis](#)
- [Engineering Analysis](#)

- [Code Validation](#)
- [Disaster Planning](#)

Appendix B-1: Model Use: Monitor System Performance

Monitor System Performance

Description:

Using analytical models and sensor data of a facility to evaluate and model the overall system performance of building structure (walls, floors, roof, etc) and equipment serving the building (mechanical, electrical, plumbing, security, etc).

Potential Value:

- Save money and environmental impact by ensuring that the building is operating to specified design and sustainable standards
- Improve system performance through analytics of operational performance
- Investigate “what if” scenarios to evaluate alternatives for a facility

Resources Required:

- Building Systems Analysis Software (Energy, Lighting, Mechanical, Other)
- Model of the architecture and related systems in a format for input into analysis packages

Team Competencies Required:

- Ability to understand and manipulate CMMS and building control systems with Record Model
- Ability to understand typical equipment operation and maintenance practices
- Ability to manipulate, navigate, and review a 3D Model

Selected Resources:

- Ayat E. Osman, Robert Ries. “ Optimization For Cogeneration Systems in Buildings Based on Life Cycle Assessment” May 2006, <http://itocn.org/2006/20/>

Appendix B-2: Model Use: Monitor Space Utilization

Monitor Space Description:

A process in which BIM is utilized to effectively distribute, manage, and track appropriate spaces and related resources within a facility. A facility building information model allows the facility management team to analyze the existing use of the space and effectively apply transition planning management towards any applicable changes. Such applications are particularly useful during a project's renovation where building segments are to remain occupied. Space Management and Tracking ensures the appropriate allocation of spatial resources throughout the life of the facility. This use benefits from the utilization of the record model. This application often requires integration with spatial tracking software.

Potential Value:

- More easily identify and allocate space for appropriate building use
- Increase the efficiency of transition planning and management
- Proficiently track the use of current space and resources
- Assist in planning future space needs for the facility

Resources Required:

- Bi-directional 3D Model Manipulation; software and record model integration
- Space mapping and management input application (Mapguide, Maximo, etc.)

Team Competencies Required:

- Ability to manipulate, navigate, and review the record model
- Ability to assess current space and assets and manage appropriately for future needs
- Knowledge of facility management applications
- Ability to effectively integrate the record model with the Facility Management's Application and appropriate software associated with the client's needs

Selected Resources:

- Thacker, J. "Total Facilities Management." 2010. 19 Sept. 2010. Technology Associates International Corporation. Web. 19 Sept. 2010.
- Mapping Your Facilities Management Future. Aug. 2009 Web. 19 Sept. 2010. Acatech Solutions.
- Vacik, Nicolas A. and Patricia Huesca-Dorantes. "Building a GIS Database for Space and Facilities

Management.” *New Directions for Institutional Research*, n120 p53-61 2003.

- Brinda, T. and Prasanna, E. “Developments of Facility Management Using Building Information Modelling,” *Int. J. Innov. Res. Sci. Eng. Technol.*, 3(4), 11379, 2014.

Appendix B-3: Model Use: Monitor Assets

Monitor Assets

Description:

A process in which an organized management system is bi-directionally linked to a record model to efficiently aid in the maintenance and operation of a facility and its assets. These assets, consisting of the physical building, systems, surrounding environment, and equipment, must be maintained, upgraded, and operated at an efficiency which will satisfy both the owner and users in the most cost-effective manner. It assists in financial decision-making, short-term and long-term planning, and generating scheduled work orders. Asset Management utilizes the data contained in a record model to populate an asset management system which is then used to determine cost implications of changing or upgrading building assets, segregate costs of assets for financial tax purposes, and maintain a current comprehensive database that can produce the value of a company's assets. The bi-directional link also allows users to visualize the asset in the model before servicing it potentially reducing service time.

Potential Value:

- Store and retrieve operations, user manuals, and equipment specifications for faster access
- Perform and analyze facility and equipment condition assessments
- Maintain up-to-date facility and equipment data including but not limited to maintenance schedules, warranties, cost data, upgrades, replacements, damages/deterioration, maintenance records, manufacturer's data, and equipment functionality
- Provide one source for tracking the use, performance, and maintenance of a building's assets for the owner, maintenance team, and financial department
- Produce accurate quantity takeoffs of current company assets which aid in financial reporting, bidding, and estimating the future cost implications of upgrades or replacements of a particular asset
- Allow for future updates of record model to show current building asset information after upgrades, replacements, or maintenance by tracking changes and importing new information into model

Resources Required:

- Asset Management system
- Ability to Bi-directional link facilities record model and Asset Management System

Team Competencies Required:

- Ability to manipulate, navigate, and review a 3D Model (preferred but not required)
- Ability to manipulate an asset management system

- Knowledge of tax requirements and related financial software
- Knowledge of construction and the operation of a building (replacements, upgrades, etc.)
- Pre-design knowledge of which assets are worth tracking, whether the building is dynamic vs. static, and the end needs of the building to satisfy the owner

Selected Resources:

- CURT. (2010) BIM Implementation: An Owner's Guide to Getting Started
- NIST (2007) General Buildings Information Handover Guide: Principles, Methodology, and Case Studies

Appendix B-4: Model Use: Monitor Maintenance

Monitor Maintenance

Description:

Using facility information models to monitor facility status and schedule maintenance activities for a facility.

Potential Value:

- Allows for proactive maintenance planning
- Gain data on maintenance history for future prediction and planning
- Increase productivity of maintenance staff by providing information needed for work orders
- Allow facility managers to justify the need and cost of establishing a reliability-centered maintenance program

Resources Required:

- Design review software to view Record Model and components
- Building Automation System (BAS) linked to Record Model
- Computerized Maintenance Management System (CMMS) linked to Record Model
- User-Friendly Dashboard Interface linked to Record Model to provide building performance information and/or other information to educate building users

Team Competencies Required:

- Ability to understand and manipulate CMMS and building control systems with Record Model
- Ability to understand typical equipment operation and maintenance practices
- Ability to manipulate, navigate, and review a 3D Model

Selected Resources:

- Campbell, D.A. (2007). BIM – Web Applications for AEC, Web 3D Symposium.
- Fallon, K. (2008). "Interoperability: Critical to Achieving BIM Benefits". AIA Edges Website:
- Singh, H.; W.H. Dunn (2008). Integrating Facilities Stovepipes for Total Asset Management (TAM). Journal of Building Information Modeling, Spring 2008. http://www.aia.org/nwsltr_tap.cfm?pagename=tap_a_0704_interop
- ASHRAE (2003). HVAC design Manual for Hospitals and Clinics. Atlanta, GA. (2004). Federal energy Management Program. O&M Best Practices: A Guide to Achieving Operational Efficiency, Release 2.0. July 2004. www1.eere.energy.gov/femp/pds.OM_5.pdf

- Piotrowski, J. (2007). Effective Predictive and Pro-Active Maintenance for Pumps, <http://www.maintenanceworld.com/effective-predictive-and-pro-active-maintenance-for-pumps/>

Appendix B-5: Model Use: Compile Record Model

Compile Record Model

Description:

A process to obtain information regarding the facility elements, surrounding conditions, and assets of a facility. The record model should, at a minimum, contain information relating to the architectural, structural, and MEP systems.

Potential Value:

- Enables easier modeling of future renovations
Improve documentation of environment for future uses, e.g., renovation or historical documentation
Provide the owner with an accurate model of the building, equipment, and spaces within a building to create possible synergies with other BIM Uses
Minimize physical documentation required for building turnover information
Enables integration of information with owner facility management systems

Resources Required:

- 3D model viewing software
- Model authoring software for any editable record model content
- Data analysis software for any information provided in data spreadsheet or database

Team Competencies Required:

- Ability to manipulate, navigate, and review 3D model
- Ability to use BIM modeling application for building updates
- Ability to thoroughly understand facility operations processes to ensure correct input of information
- Ability to effectively communicate between the design, construction, and facilities management teams

Selected Resources:

- Brown, J. L. (September 2009). Wisconsin Bets on BIM. *Civil Engineering*, 40-41.
- CRC for Construction Innovation. Adopting BIM for Facilities Management – Solutions for Managing the Sydney Opera House.
- Gregerson, J. (December 2009). For Owners, BIM Has Vim. *Buildings*, 26.
- Knight, D., Roth, S., & Rosen, S. (June 2010). Using BIM in HVAC Design. *ASHRAE Journal*, 24-34.
- Madsen, J. J. (July 2008). Build Smarter, Faster, and Cheaper with BIM. *Buildings*, 94-96.

- McKew, H. (July 2009). Owners, Please Demand More From Your IPD Team. *Engineered Systems*, 50.
- Woo, J., Wilsmann, J., & Kang, D. (2010). Use of As-Built Building Information Modeling. *Construction Research Congress 2010*, 538-548.

Appendix B-6: Model Use: Layout Construction Work

Layout Construction Work

Description:

Using model information to layout facility assemblies or automate control of automated equipment on a construction project.

Potential Value:

- Decrease layout errors
Increase efficiency and productivity by decreasing time spent surveying in the field
Reduce rework since control points are received directly from the model

Resources Required:

- Machinery with GPS capabilities
- Digital Layout Equipment
- Model transition software or capabilities (what software takes the model and converts it to usable information)

Team Competencies Required:

- Ability to create, manipulate, navigate and review 3D model
- Ability to interpret if model data is appropriate for layout and equipment control

Selected Resources:

- Garrett, R. E. (2007). PennDOT About to Embrace GPS Technology. Jan-Feb. Retrieved 2010, from [gradingandexcavation.com](http://www.gradingandexcavation.com): <http://www.gradingandexcavation.com/january-february-2007/penn-dot-gps-technology.aspx>
- Strafaci, A. (2008, October). What Does BIM Mean for Civil Engineers? Retrieved 2010, from [cenews.com](http://images.autodesk.com/emea_s_main/files/what_does_bim_mean_for_civil_engineers_ce_news_1008.pdf): http://images.autodesk.com/emea_s_main/files/what_does_bim_mean_for_civil_engineers_ce_news_1008.pdf
- TEKLA International. (2008, October 28). Tekla Corporation and Trimble to Improve Construction Field Layout Using Building Information Modeling. Retrieved 2010, from [tekla.com](http://www.tekla.com/us/about-us/news/Pages/TeklaTrimble.aspx): <http://www.tekla.com/us/about-us/news/Pages/TeklaTrimble.aspx>

Appendix B-7: Model Use: Fabricate Product

Fabricate Product Description:

Using information from a model to fabricate of construction materials, assemblies or modules. Examples include sheet metal / pipe fabrication, structural steel fabrication, wall panel fabrication, and wall assembly fabrication.

Potential Value:

- Improved product quality through machine fabrication
- Increased fabrication productivity and safety
- Reduce lead time
- Reduce the impact of late changes in design
- Increased labor productivity and safety

Resources Required:

- Design Authoring Software
- Machine-readable data for fabrication
- Fabrication methods

Team Competencies Required:

- Ability to understand and create fabrication models
- Ability to manipulate, navigate, and review a 3D model
- Ability to extract digital information for fabrication from 3D models
- Ability to manufacture building components using digital information
- Ability to understand typical fabrication methods

Selected Resources:

- Eastman, C. (2008) "BIM Handbook A Guide to Building Information Modeling for Owners, Managers, Designers, Engineers, and Contractors."
- Papanikolaou, D. (2008). "Digital Fabrication Production System Theory: towards an integrated environment for design and production of assemblies." Cuba, 484-488.
- Reifschneider, M. (2009). "Managing the quality if structural steel Building Information Modeling."

- Rundell, R. (2008). "BIM and Digital Fabrication (1-2-3 Revit Tutorial)."
- Sass, L. (2005). "A production system for design and construction with digital fabrication." MIT.
- Seely, J. C. (2004). "Digital Fabrication in the Architectural Design Process." Master Thesis, Massachusetts Institute of Technology.

Appendix B-8: Model Use: Author Temporary Construction Systems Model

Author Temporary Construction Systems Model

Description:

Using BIM to author the design of the temporary systems required for the construction of the permanent building systems. These temporary systems can include concrete formwork, scaffolding, support of excavation systems, temporary shoring, temporary heating, temporary lighting, or other engineered temporary construction systems.

Potential Value:

- Increase construction safety and productivity
 - Improved safety through visualization and analytics
 - Increase safety awareness of a complex building system
- Improved communication with workforce through better visualization
- Improve constructability of complex building system through detailed analysis
- Enables automation of work package development including takeoffs and details

Resources Required:

- Design authoring software that supports construction system design

Team Competencies Required:

- Ability to manipulate, navigate, and review 3D model
- Ability to make appropriate construction decisions using a 3D System Design Software
- Knowledge of typical and appropriate construction practices for each component

Selected Resources:

- Leventhal, Lauren." Delivering Instruction for Inherently-3D Construction Tasks: Lessons and Questions for Universal Accessibility". Workshop on Universal Accessibility of Ubiquitous Computing: Providing for the elderly.
- Khemlano (2007). AECbytes: Building the Future (October 18).

Appendix B-9: Model Use: Author Construction Site Logistics Model

Author Construction Site Logistics Model

Description:

Authoring a model of both permanent and temporary facilities on a site during multiple phases of the construction process to communicate the physical site conditions and plan the overall logistics. It may also be linked with the construction activity schedule to convey space and sequencing requirements. Additional information incorporated into the model can include labor resources, materials with associated deliveries, and equipment location. Because the 3D model components can be directly linked to the schedule, site management functions such as visualized planning, short-term re-planning, and resource analysis can be analyzed over different spatial and temporal data.

Potential Value:

- Efficiently generate site usage layout for temporary facilities, assembly areas, and material deliveries for all phases of construction
- Quickly identify potential and critical space and time conflicts
- Accurately evaluate site layout for safety concerns
- Select a feasible construction scheme
- Effectively communicate construction sequence and layout to all interested parties
- Easily update site organization and space usage as construction progresses
- Minimize the amount of time spent performing site utilization planning

Resources Required:

- Design authoring software
- Scheduling software
- 4D model integration software
- Detailed existing conditions site plan

Team Competencies Required:

- Ability to create, manipulate, navigate, and review a 3D Model
- Ability to manipulate and assess the construction schedule with a 3D model
- Ability to understand typical construction methods

- Ability to translate field knowledge to a technological process

Selected Resources:

- Chau, K.W.; M. Anson, and J.P. Zhang. (July/August 2004) "Four-Dimensional Visualization of Construction Scheduling and Site Utilization." *Journal of Construction Engineering and Management*. 598-606. ASCE. 5 September 2008. <http://cedb.asce.org/cgi/WWWdisplay.cgi?0410956>
- Dawood, N. et al. (2005) "The Virtual Construction Site (VIRCON) Tools: An Industrial Evaluation." *ITcon*. Vol. 10 43-54. 8 September 2008. http://www.itcon.org/cgi-bin/works/Show?2005_5
- Heesom, David and Lamine Mahdjoubi. (February 2004) "Trends of 4D CAD Applications for Construction Planning." *Construction Management and Economics*. 22 171-182. 8 September 2008. <http://www.tamu.edu/classes/choudhury/articles/1.pdf>
- J.P. Zhang, M. Anson and Q. Wang. (2000) "A New 4D Management Approach to Construction Planning and Site Space Utilization." *Proceedings of the Eighth International Conference on Computing in Civil and Building Engineering* 279, 3 (2000) ASCE. 21 September 2010. [http://dx.doi.org/10.1061/40513\(279\)3](http://dx.doi.org/10.1061/40513(279)3).
- J. H. Kang, S. D. Anderson, M. J. Clayton. (June 2007) "Empirical Study on the Merit of Web-Based 4D Visualization in Collaborative Construction Planning and Scheduling." *J. Constr. Engrg. and Mgmt.* Volume 133, Issue 6, pp. 447-461 ASCE. 20 September 2010. [http://dx.doi.org/10.1061/\(ASCE\)0733-9364\(2007\)133:6\(447\)](http://dx.doi.org/10.1061/(ASCE)0733-9364(2007)133:6(447))
- Timo Hartmann, Ju Gao and Martin Fischer. (October 2008) "Areas of Application for 3D and 4D Models." *Journal of Construction Engineering and Management* (Volume 135, Issue 10): 776-785.
- Ting Huang, C.W. Kong, H.L. Guo, Andrew Baldwin, Heng Li. (August 2007) "A Virtual Prototyping System for Simulating Construction Processes." *Automation in Construction* (Volume 16, Issue 5):Pages 576-585, (<http://www.sciencedirect.com/science/article/B6V20-4MFJT9J-1/2/45a7645cc1a6836c45317a012fbc181a>)

Appendix B10: Model Use: Draw Construction Documents

Draw Construction Documents

Description:

Using BIM to develop the documentation necessary to communicate the facility design to the construction personnel. This may include plans, elevations, sections, renderings, data schedules, 3D diagrams, or specifications.

Potential Value:

- High-quality construction documentation can increase productivity, reduce field conflicts, and improve the overall quality
- Model generated documentation can enable additional data for the construction workforce with limited additional effort, e.g., 3D views and additional data such as material takeoff quantities and specification information
- Automatic updating of documentation with design revision tracking

Resources Required:

- BIM authoring software that enables document creation
- Specification authoring software (if you wish to autogenerate specifications)

Team Competencies Required:

- Ability to develop documentation within BIM authoring software
- Ability to track and publish document revisions

Selected Resources:

- Yi-Feng Chang & Shen-Guan Shih (2013) BIM-based Computer-Aided Architectural Design, Computer-Aided Design and Applications, 10:1, 97-109, DOI: 10.3722/cadaps.2013.97-109 (available at <https://www.tandfonline.com/doi/abs/10.3722/cadaps.2013.97-109>)

Appendix B-11: Model Use: Analyze Sustainability Performance

Sustainability (LEED) Evaluation

Description:

A process in which a BIM project is evaluated based on LEED or other sustainable criteria. This process should occur during all stages of a facilities life including planning, design, construction, and operation. Applying sustainable features to a project in the planning and early design phases is more effective (ability to impact design) and efficient (cost and schedule of decisions). This comprehensive process requires more disciplines to interact earlier by providing valuable insights. This integration may require contractual integration in the planning phase. In addition to achieving sustainable goals, having LEED approval process adds certain calculations, documentation, and verifications. Energy simulations, calculations, and documentation can be performed within an integrative environment when responsibilities are well defined and clearly shared.

Potential Value:

- Facilitates interaction, collaboration, and coordination of team members early in the project process are considered to be favorable to sustainable projects.
- Enables early and reliable evaluation of design alternatives.
- Availability of critical information early helps problem resolution efficiently in terms of cost premium and schedule conflicts.
- Shortens the actual design process by the help of early facilitated design decisions. A shorter design process is cost effective and provides more time for other projects.
- Leads to delivery better project quality.
- Reduces documentation load after design and accelerates certification because concurrently prepared calculations can be used for verification.
- Reduces operational costs of the facility due to the energy performance of the project. It optimized building performance via improved energy management.
- Increases the emphasis on environmentally friendly and sustainable design.
- Assist project team with potential future revisions throughout the life cycle.

Resources Required:

- Design authoring software
- Sustainability evaluation criteria tracking software

Team Competencies Required:

- Ability to create and review 3D Model
- Knowledge of up-to-date sustainability evaluation criteria
- Ability to organize and manage the database

Selected Resources:

- Krygiel, E., and Brad, N., 2008, "Green BIM: Successful Sustainable Design with Building Information Modeling," San Francisco.
- McGraw Hill Construction, 2010, "Green BIM-How Building Information Modeling Is Contributing to Green Design and Construction," Smart Market Report, McGraw Hill Construction.
- Balfour Beatty Construction, 2010, "Sustainability and Engineering Guide Version 2.0," Balfour Beatty Construction.

Appendix B-12: Model Use: Review Design Model(s)

Review Design Model

Description:

A process in which stakeholders view a 3D model and provide their feedbacks to validate multiple design aspects. These aspects include evaluating meeting the program, previewing space aesthetics and layout in a virtual environment, and setting criteria such as layout, sightlines, lighting, security, ergonomics, acoustics, textures and colors, etc. This BIM use can be done by using computer software only or with special virtual mock-up facilities, such as CAVE (Computer Assisted Virtual Environment) and immersive lab. Virtual mock-ups can be performed at various levels of detail depending on project needs. An example of this is to create a highly detailed model of a small portion of the building, such as a facade to quickly analyze design alternatives and solve design and constructability issues.

Potential Value:

- Eliminate costly and timely traditional construction mock-ups
- Different design options and alternatives may be easily modeled and changed in real-time during design review base on end users and/or owner feedbacks
- Create shorter and more efficient design and design review process
- Evaluate the effectiveness of design in meeting building program criteria and owner's needs
- Enhance the health, safety and welfare performance of their projects (For instance, BIM can be used to analyze and compare fire-rated egress enclosures, automatic sprinkler system designs, and alternate stair layouts)
- Easily communicate the design to the owner, construction team and end users
- Get instant feedback on meeting program requirements, owner's needs and building or space aesthetics
- Greatly increase coordination and communication between different parties. More likely to generate better decisions for design

Resources Required:

- Design Review Software
- Interactive review space
- Hardware which is capable of processing potential large model files

Team Competencies Required:

- ? Ability to manipulate, navigate, and review a 3D model
- ? Ability to model photo realistically including textures, colors, and finishes and easily navigable by using

different software or plug-ins

- ? Strong sense of coordination. Understanding the roles and responsibilities of team members
- ? Strong understanding of how building/facility systems integrate with one another

Selected Resources:

- Bassanino, May Wu, Kuo-Cheng Yao, Jialiang Khosrowshahi, Farzad Fernando, Terrence Skjaerbaek, Jens. (2010). "The Impact of Immersive Virtual Reality on Visualisation for a Design Review in Construction," 14th International Conference Information Visualisation.
- Dunston, P., Arns, L., and McGlothin, J. (2007). "An Immersive Virtual Reality Mock-Up for Design Review of Hospital Patient Rooms," 7th International Conference on Construction Applications of Virtual Reality, University Park, Pennsylvania, October 22-23.
- Majumdar, Tulika, Fischer, Martin A., and Schwegler, Benedict R. (2006). "Conceptual Design Review with a Virtual Reality Mock-Up Model," Building on IT: Joint International Conference on Computing and Decision Making in Civil and Building Engineering, Hugues Rivard, Edmond Miresco, and Hani Melham, editors, Montreal, Canada, June 14-16, 2902-2911.
- Maldovan, Kurt D., Messner, John I., and Faddoul, Mera (2006). "Framework for Reviewing Mockups in an Immersive Environment," CONVR 2006:6th International Conference on Construction Applications of Virtual Reality, Orlando, Florida, August 3-4, on CD.
- NavisWorks. (2007), "Integrated BIM and Design Review for Safer, Better Buildings," (http://www.eua.com/pdf/resources/integrated_project/Integrated_BIM-safer_better_buildings.pdf).
- Shiratuddin, M. and Thabet, W. (2003). "Framework for a Collaborative Design Review System Utilizing the Unreal Tournament (UT) Game Development Tool," CIB Report.
- Xiangyu Wang and Phillip S. Dunston. (2005). "System Evaluation of a Mixed Reality-Based Collaborative Prototype for Mechanical Design Review Collaboration," Computing in Civil Engineering, 21(6), 393-401.

Appendix B-13: Model Use: Coordinate Design Model(s)

Coordinate Design Model(s)

Description:

Using 3D coordination software to compile a federated model of design models for performing automated 3D collision detection to identify potential coordination issues along with performing a visual analysis to identify potential spatial design issues. The federated model may include permanent design elements, temporary construction elements, and potential operational elements including clearances or other furnishings.

Potential Value:

- Reduces or eliminates field conflicts
 - Reduces project cost
 - Reduces project schedule
 - Increases project quality
 - Increases workforce productivity
 - Reduces construction waste
 - Reduces field generated requests for information
- Increases spatial reliability
 - Enables increased levels of prefabrication and modularization
 - Enables installation of hangers for MEP or structural elements prior to concrete placement
- Improves the quality of as-built information

Resources Required:

- Design models
- 3D coordination software for federating and spatially analyzing models

Team Competencies Required:

- Ability to manage 3D coordination activities
- Ability to manipulate, navigate, and review a 3D model

Select References:

- Staub-French S and Khanzode A (2007) "3D and 4D Modeling for design and construction coordination: issues and lessons learned" ITcon Vol. 12, pg. 381-407, <http://www.itcon.org/2007/26>
- Khanzode A, Fischer M, Reed D (2008) "Benefits and lessons learned of implementing building virtual design and construction (VDC) technologies for coordination of mechanical, electrical, and plumbing (MEP) systems on a large healthcare project", ITcon Vol. 13, Special Issue Case studies of BIM Use , 324-342, <http://www.itcon.org/2008/22>

Appendix B-14: Model Use: Analyze Lighting Performance

Analyze Lighting Performance

Description:

Leveraging the model to perform a quantitative and aesthetic review of the lighting conditions within a space or on a surface or series of surfaces. This can include daylighting analysis or artificial lighting analysis.

Potential Value:

- Visually review lighting conditions
- Provide quantitative results for energy use calculations
- Show daylight impact on a space
- Allow for review of space for placement of daylight sensors

Resources Required:

- A model with 3D information of all objects that influence lighting conditions. This may include some finish properties and furnishings within the model depending upon the detail desired within the lighting analysis.
- A lighting analysis software to perform renderings and lighting calculations

Team Competencies Required:

- Modeler with skills to place lights within a 3D model
- Designer with skills to interpret analysis results

Selected References:

-

Appendix B-15: Model Use: Analyze Structural Performance

Structural Analysis

Description:

A process in which analytical modeling software utilizes the BIM design authoring model so to determine the behavior of a given structural system. With the modeling minimum required standards for structural design and analysis are used for optimization. Based on this analysis further development and refinement of the structural design takes place to create effective, efficient, and constructible structural systems. The development of this information is the basis for what will be passed onto the digital fabrication and construction system design phases.

This BIM Use does not need to be implemented from the beginning of the design to be beneficial. Often structural analysis is implemented at the connection design level to make fabrication quicker, more efficient and for better coordination during construction. Another application is that this relates and ties into is construction system design, examples include but not limited to: erection design, construction means and methods, and rigging. The application of this analysis tool allows for performance simulations that can significantly improve the design, performance, and safety of the facility over its lifecycle.

Potential Value:

- Save time and cost on creating extra models
- Easier transition BIM authoring tools allowing new firms implementing this use model
- Improve specialized expertise and services offered by the design firm
- Achieve optimum efficient design solutions by applying various rigorous analyses
- Faster return on investment by applying audit and analysis tools for engineering analyses
- Improve the quality of the design analyses
- Reduce the cycle time of the design analyses

Resources Required:

- Design Authoring Tools
- Structural Engineering analysis tools and software
- Design standards and codes
- Adequate hardware for running software

Team Competencies Required:

- Ability to create, manipulate, navigate, and review a 3D Structural Model

- Knowledge of constructability methods
- Structural design and analysis experience
- Experience in structural sequencing methods

Selected References:

- Ikerd, W. (2007) "The Importance of BIM in Structural Engineering: The greatest change in over a century" Structure Magazine, Oct. 37-40
- Burt, Bruce (2009) "BIM Interoperability: the Promise and the Reality" Structure Magazine, Dec. 19-21
- Faraone, Thomas, et al. (2009) "BIM Resources for the AEC Community" Structure Magazine, Mar. 32-33
- Eastman et al (2010) "Exchange Model and Exchange Object Concepts for Implementation of National BIM Standards", Journal of Computing in Civil Engineering, (Jan./Feb.) 25-34. ASCE.
- Barak et al (2009) "Unique Requirements of Building Information Modeling for CIP Reinforced Concrete", ASCE Journal of Computing in Civil Engineering, Mar./Apr. 64-74.

Appendix B-16: Model Use: Analyze Energy Performance

Analyze Energy Performance

Description:

The BIM Use of Facility Energy Analysis is a process in the facility design phase which one or more building energy simulation programs use a properly adjusted BIM model to conduct energy assessments for the current building design. The core goal of this BIM use is to inspect building energy standard compatibility and seek opportunities to optimize the proposed design to reduce structure's life-cycle costs.

Potential Value:

- Save time and costs by obtaining building and system information automatically from the building information model instead of inputting data manually
- Improve building energy prediction accuracy by auto-determining building information such as geometries, volumes precisely from BIM model
- Help with building energy code verification
- Optimize building design for better building performance efficiency and reduce building life-cycle cost

Resources Required:

- Building Energy Simulation and Analysis Software(s)
- Well-adjusted Building 3D-BIM Model
- Detailed Local Weather Data
- National/Local Building Energy Standards (e.g., ASHRAE Standard 90.1)

Team Competencies Required:

- Knowledge of basic building energy systems
- Knowledge of compatible building energy standard
- Knowledge and experience of building system design
- Ability to manipulate, navigate, and review a 3D Model
- Ability to assess a model through engineering analysis tools

Selected References:

- ASHRAE (2009). ASHRAE Handbook-Fundamentals. Atlanta. American Society of Heating, Refrigerating and Air-Conditioning Engineers, Inc.
- Crawley, D. B., Hand, J. W., et al (2008). Contrasting the capabilities of building energy performance

simulation program. *Building and Environment* 43, 661-673.

- Bazjanac. V. 2008. IFC BIM-Based Methodology for Semi-Automated Building Energy Performance Simulation. *Proceedings of CIB-W78 25th International Conference on Information Technology in Construction*.
- Stumpf. A., Kim. H., Jenicek. E. (2009). Early Design Energy Analysis Using BIMS (Building Information Models). *2009 Construction Research Congress*. ASCE.
- Cho. Y. K., Alaskar. S., and Bode.T.A. (2010). BIM-Integrated Sustainable Material and Renewable Energy Simulation. *2010 Construction Research Congress*. ASCE.

Appendix B-17: Model Use: Author 4D Model

Author 4D Model

Description:

A process in which a 4D model (3D models with the added dimension of time) is utilized to effectively plan the phased occupancy in a renovation, retrofit, addition, or to show the construction sequence and space requirements on a building site. 4D modeling is a powerful visualization and communication tool that can give a project team, including the owner, a better understanding of project milestones and construction plans.

Potential Value:

- Better understanding of the phasing schedule by the owner and project participants and showing the critical path of the project
- Dynamic phasing plans of occupancy offering multiple options and solutions to space conflicts
- Integrate planning of human, equipment and material resources with the BIM model to better schedule and cost estimate the project
- Space and workspace conflicts identified and resolved ahead of the construction process
- Marketing purposes and publicity
- Identification of schedule, sequencing or phasing issues
- More readily constructible, operable and maintainable project
- Monitor procurement status of project materials
- Increased productivity and decreased waste on job sites
- Conveying the spatial complexities of the project, planning information, and support conducting additional analyses

Resources Required:

- Design Authoring Software
- Scheduling Software
- 4D Modeling Software

Team Competencies Required:

- Knowledge of construction scheduling and general construction process. A 4D model is connected to a schedule, and is therefore only as good as the schedule to which it is linked.
- Ability to manipulate, navigate, and review a 3D model.
- Knowledge of 4D software: import geometry, manage links to schedules, produce and control

animations, etc.

Selected Resources:

- Dawood, N., and Mallasi, Z. (2006). Construction Workplace Planning: Assignment and Analysis Utilizing 4D Visualization Technologies. *Computer-aided Civil and Infrastructure Engineering*, Pgs. 498-513.
- Jongeling, R., Kim, J., Fischer, M., Morgeous, C., and Olofsson, T. (2008). Quantitative analysis of workflow, temporary structure usage, and productivity using 4D models. *Automation in Construction*, Pgs. 780-791.
- Kang, J., Anderson, S., and Clayton, M. (2007). "Empirical Study on the Merit of Web-based 4D Visualization in Collaborative Construction Planning and Scheduling". *Journal of Construction Engineering and Management*. 447-461.

Appendix B-18: Model Use: Author Cost Estimate

Author Cost Estimate

Description:

A process in which BIM can be used to assist in the generation of accurate quantity take-offs and cost estimates throughout the lifecycle of a project. This process allows the project team to see the cost effects of their changes, during all phases of the project, which can help curb excessive budget overruns due to project modifications. Specifically, BIM can provide cost effects of additions and modifications, with the potential to save time and money and is most beneficial in the early design stages of a project.

Potential Value:

- Precisely quantify modeled materials
- Quickly generate quantities to assist in the decision-making process
- Generate more cost estimates at a faster rate
- Better visual representation of project and construction elements that must be estimated
- Provide cost information to the owner during the early decision-making phase of design and throughout the lifecycle, including changes during construction
- Saves estimator's time by reducing quantity take-off time
- Allows estimator's to focus on more value adding activities in estimating such as: identifying construction assemblies, generating pricing and factoring risks, which are essential for high-quality estimates
- Added to a construction schedule (such as a 4D Model), a BIM developed cost estimate can help track budgets throughout the construction
- Easier exploration of different design options and concepts within the owner's budget
- Quickly determine costs of specific objects
- Easier to train new estimators through this highly visual process

Resources Required:

- Model-based estimating software
- Design authoring software
- An accurately built design model
- Cost data (Including MasterFormat and Unifomat data)

Team Competencies Required:

- Ability to define specific design modeling procedures which yield accurate quantity take-off information

- Ability to identify quantities for the appropriate estimating level (e.g. ROM, SF, etc.) upfront
- Ability to manipulate models to acquire quantities usable for estimation

Selected Resources:

- Lee, H., Lee, Kim, J. (2008). A cost-based interior design decision support system for large-scale housing projects, ITcon Vol. 13, Pg. 20-38, <http://www.itcon.org/2008/2>
- Autodesk Revit. (2007) "BIM and Cost Estimating." Press release. Autodesk. 11 Sept. 2008. http://images.autodesk.com/adsk/files/bim_cost_estimating_jan07_1_.pdf
- Dean, R. P., and McClendon, S. (2007). "Specifying and Cost Estimating with BIM." ARCHITECT. Apr. 2007. <http://www.architechmag.com/articles/detail.aspx?contentid=3624>.
- Khemlani, L. (2006). "Visual Estimating: Extending BIM to Construction." AEC Bytes. 21 Mar. 2006. 13 Sept. 2008. <http://www.aecbytes.com/buildingthefuture/2006/visualestimating.html>
- Buckley, B. (2008). "BIM Cost Management." California Construction. June 2008. 13 Sept. 2008.
- Manning, R. and Messner, J. (2008). "Case studies in BIM implementation for programming of healthcare facilities". ITcon Vol. 13, Special Issue Case studies of BIM Use, 246-257, <http://www.itcon.org/2008/18>
- Shen, Z. and Issa R. (2010). "Quantitative evaluation of the BIM-assisted construction detailed cost estimates". Journal of Information Technology in Construction (ITcon), 15, 234-257, <http://www.itcon.org/2010/18>
- McCuen, T. (2009). Cost Estimating in BIM: The Fifth Dimension. Nov. Retrieved September 21, 2010, from Construction Advisor Today: <http://constructionadvisortoday.com/2009/11/cost-estimating-in-bim-the-fifth-dimension.html>

Appendix B-19: Model Use: Analyze Program Requirements

Analyze Program Requirements

Description:

A process in which a spatial program is used to efficiently and accurately assess design performance in regard to spatial requirements. The developed BIM model allows the project team to analyze space and understand the complexity of space standards and regulations. Critical decisions are made in this phase of design and bring the most value to the project when needs and options are discussed with the client and the best approach is analyzed.

Potential Value:

- Efficient and accurate assessment of design performance in regard to spatial requirements by the owner.

Resources Required:

- Design Authoring Software

Team Competencies Required:

- Ability to manipulate, navigate, and review a 3D model

Selected Resources:

- *GSA BIM Guide 02 – Spatial Program Validation*, The National 3D-4D BIM Program U.S. General Services Administration, Washington, DC. <https://www.gsa.gov/real-estate/design-construction/3d4d-building-information-modeling/bim-guides/bim-guide-02-spatial-program-validation>
- Manning, R. and Messner, J. (2008). "Case studies in BIM implementation for programming of healthcare facilities." *Journal of Information Technology in Construction (ITcon)*. 13, 246-257. <https://www.itcon.org/paper/2008/18>

[Link to Example Process Map](#) (see Appendix D for additional process maps)

Appendix B-20: Model Use: Author Design

Author Design

Description:

Using BIM authoring software to develop a model with 3D and additional attribute information for a facility design leveraging a library of parametric design elements.

Potential Value:

- Transparency of design for all stakeholders
- Improve control and quality control of design, cost and schedule
- Enable powerful design visualization
- Enable true collaboration between project stakeholders and BIM users
- Improve quality control and assurance

Resources Required:

- Design authoring software

Team Competencies Required:

- Ability to create, manipulate, navigate, and review a 3D model
- Knowledge of construction means and methods

Selected References:

- Tardif, M. (2008). BIM: Reaching Forward, Reaching Back. AIArchitect This Week. Face of the AIA. AIArchitect.

Appendix B-21: Model Use: Capture Existing Conditions

Capture Existing Conditions

Description:

A process in which a project team develops a 3D model of the existing conditions for a site, facilities on a site, or a specific area within a facility. This model can be developed in multiple ways: including laser scanning and conventional surveying techniques, depending on what is desired and what is most efficient. Once the model is constructed, it can be queried for information, whether it is for new construction or a modernization project.

Potential Value:

- Enhances the efficiency and accuracy of existing conditions documentation
- Provides documentation of environment for future uses
- Aids in future modeling and 3D design coordination
- Provides an accurate representation of work that has been put into place
- Real-time quantity verification for accounting purposes
- Provides detailed layout information
- Pre-Disaster planning
- Post-Disaster record
- Use for visualization purposes

Resources Required:

- Building Information Model modeling software
- Laser scanning point cloud manipulation software
- 3D Laser scanning
- Conventional surveying equipment

Team Competencies Required:

- Ability to manipulate, navigate, and review a 3D model
- Knowledge of Building Information Model authoring tools
- Knowledge of 3D laser scanning tools
- Knowledge of conventional surveying tools and equipment
- Ability to sift through mass quantities of data that is generated by a 3D laser scan
- Ability to determine what level of detail will be required to add “value” to the project

- Ability to generate Building Information Model from 3D laser scan and/or conventional survey data

Selected Resources:

- United States General Services Administration (2009). "GSA Building Information Modeling Guide Series: 03 – GSA BIM Guide of 3D Imaging."
- Arayici, Y. (2008). "Towards building information modeling for existing structures." Structural Survey 26.3: 210. ABI/INFORM Global.
- Murphy, M., McGovern, E., and Pavia, S. (2009)."Historic Building Information Modelling (HBIM)." Structural Survey 27.4: 311. ABI/INFORM Global.
- Adan, A., Akinci, B., Huber, D., Pingbo, Okorn, B., Tang, P. and Xiong, X. (2010)."Using Laser Scanners for Modeling and Analysis in Architecture, Engineering, and Construction."

Sample Process Map (also in Appendix D).

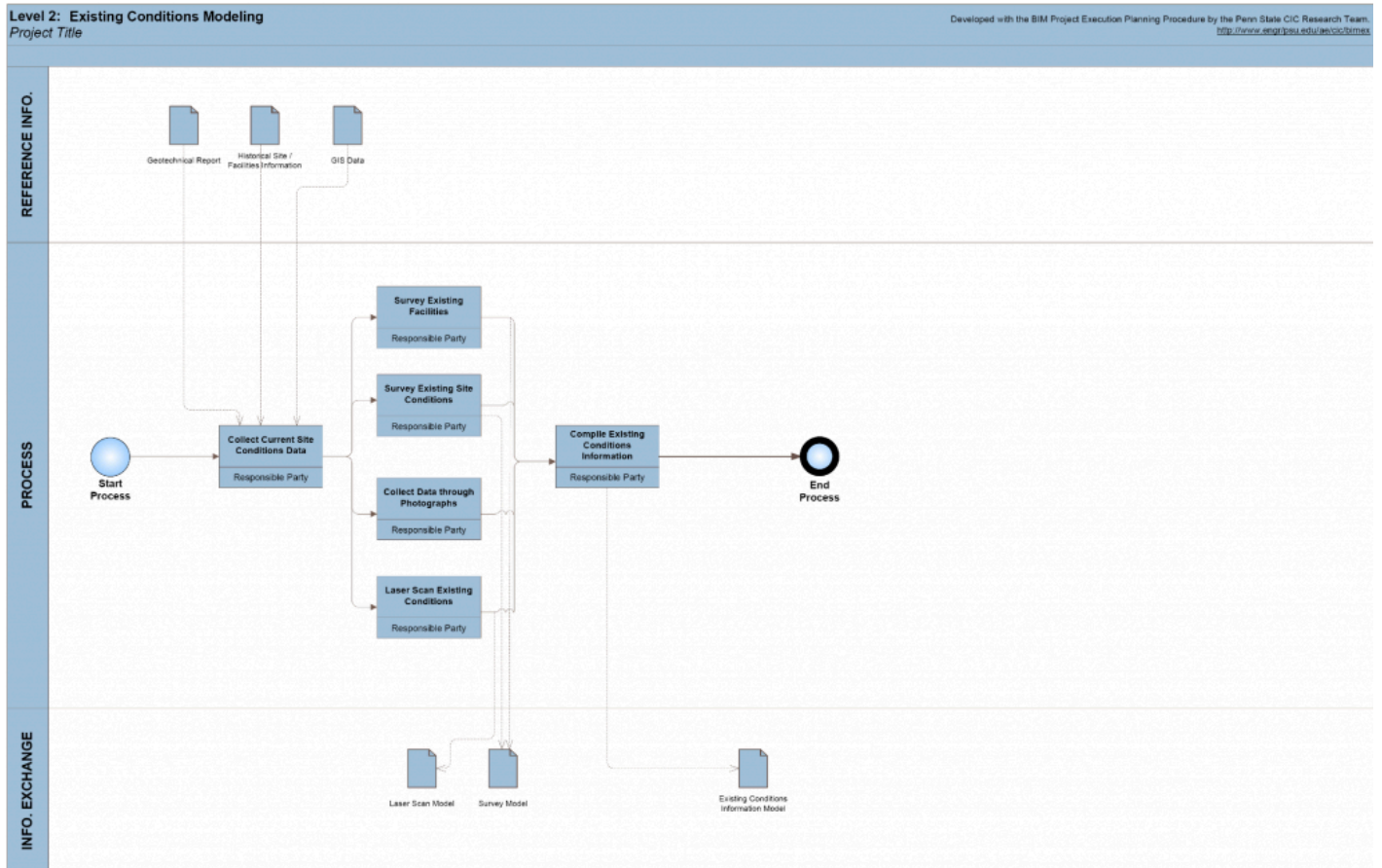

Figure D.2 – Level 2 Existing Conditions Modeling Template

Appendix B-22: Additional Model Use: Analyze Site Selection Criteria

Analyze Site Selection Criteria

Description:

A process in which BIM/GIS tools are used to evaluate properties in a given area to determine the most optimal site location for a future project. The site data collected is used to first select the site and then position the building based on other criteria.

Potential Value:

- Use calculated decision making to determine if potential sites meet the required criteria according to project requirements, technical factors, and financial factors
- Decrease costs of utility demand and demolition
- Increase energy efficiency
- Minimize the risk of hazardous material
- Maximize return on investment

Resources Required:

- GIS software
- Design Authoring Software

Team Competencies Required:

- Ability to manipulate, navigate, and review a 3D model
- Knowledge and understanding of local authority's system (GIS, database information)

Selected Resources:

- The Site Selection Guide. US General Services Administration (GSA) Public Building Service.
- Wallace, R. (2004). "Optimal Site Selection for Military Land Management". ASCE Conf. Proc. 138, 159. DOI: 10. 1061/40737(2004)159.
- Farnsworth, S. (1995). "Site Selection Perspective." Prospecting Sites. June, 29-31.
- WPBG Sustainable Committee. Optimizing Site Potential.
- Suermann P. (2005). "Leveraging GIS Tools in Defense and Response at the U.S. Air Force Academy." ASCE Conf. Proc. 179, 82 DOI: 10. 1061/40794(179)82.

- Venigalla, M. and Baik, B. (2007). "GIS-Based Engineering Management Service Functions: Taking GIS Beyond Mapping for Municipal Governments." *Journal of Computing in Civil Engineering*, ASCE, [https://doi.org/10.1061/\(ASCE\)0887-3801\(2007\)21:5\(331\)](https://doi.org/10.1061/(ASCE)0887-3801(2007)21:5(331)).

Appendix B-23: Model Use: Analyze Engineering Performance

Engineering Analysis (Structural, Lighting, Energy, Mechanical, Other)

Description:

A process in which intelligent modeling software uses the BIM model to determine the most effective engineering method based on design specifications. Development of this information is the basis for what will be passed on to the owner and/or operator for use in the building's systems (i.e. energy analysis, structural analysis, emergency evacuation planning, etc.). These analysis tools and performance simulations can significantly improve the design of the facility and its energy consumption during its lifecycle in the future.

Potential Value:

- Automating analysis and saving time and cost
- Analysis tools are less costly than BIM authoring tools, easier to learn and implement and less disruptive to established workflow
- Improve specialized expertise and services offered by the design firm
- Achieve optimum, energy-efficient design solution by applying various rigorous analyses
- Faster return on investment by applying audit and analysis tools for engineering analyses
- Improve the quality and reduce the cycle time of the design analyses

Resources Required:

- Design Authoring Tools
- Engineering analysis tools and software

Team Competencies Required:

- Ability to manipulate, navigate, and review a 3D Model
- Ability to assess a model through engineering analysis tools
- Knowledge of construction means and methods
- Design and construction experience

Selected References:

- Malin, N. (2008). BIM Companies Acquiring Energy Modeling Capabilities. <http://greensource.construction.com/news/080403BIMModeling.asp>

- Marsh, A. (2006). Ecotect as a Teaching Tool. <http://naturalfrequency.com/articles/ecotectasteacher>
- Marsh, A. (2006). Building Analysis: Work Smart, Not Hard. <http://naturalfrequency.com/articles/smartmodelling>
- Novitzki, B. (2008). Energy Modeling for Sustainability. <http://continuingeducation.construction.com/article.php?L=5&C=399>
- Stumpf, A., Brucker, B. (2008). BIM Enables Early Design Energy Analysis. <http://www.cecer.army.mil/td/tips/docs/BIM-EnergyAnalysis.pdf>
- PIER Building Program (2008). Estimating Energy Use Early and Often. www.esource.com/esource/getpub/public/pdf/cec/CEC-TB-13_EstEnergyUse.pdf
- Ecotect – Building Analysis for Designers. (2007). <http://www.cabs-cad.com/ecotect.htm>
- Khemlani (2007). AECbytes: Building the Future (October 18)

Appendix B-24: Additional Model Use: Validate Code Compliance

Code Validation

Description:

A process in which code validation software is utilized to check the model parameters against project-specific codes. Code validation is currently in its infant stage of development within the U.S. and is not in widespread use. However, as model checking tools continue to develop, code compliance software with more codes, code validation should become more prevalent within the design industry.

Potential Value:

- Validate that building design is in compliance with specific codes, e.g., IBC International Building Code, ADA Americans with Disabilities Act guidelines and other project related codes using the 3D BIM model.
- Code validation done early in design reduces the chance of code design errors, omissions or oversights that would be time-consuming and more expensive to correct later in design or construction.
- Code validation is performed automatically while the design progresses giving continuous feedback on code compliance.
- Reduced turnaround time for 3D BIM model review by local code officials or reduced time that needs to be spent meeting with code commissioners, visiting the site, etc. or fixing code violations during punch list or closeout phase.
- Saves time on multiple checking for code compliance and allows for a more efficient design process since mistakes cost time and money.

Resources Required:

- Local code knowledge
- Model checking software
- 3D Model manipulation

Team Competencies Required:

- Ability to use BIM authoring tool for design and model checking tool for design review
- Ability to use code validation software and previous knowledge and experience with checking codes is needed

Selected Resources:

- Automated Circulation Validation using BIM. GSA. 1-22.
- Eastman, C., Liston, K., Sacks, R. and Teicholz, P. BIM Handbook: A Guide to Building Information Modeling for Owners, Managers, Designers, Engineers and Contractors. New York, NY: Wiley, 2008

Appendix B-25: Additional Model Use: Analyze Emergency Management

Analyze Emergency Management **

Description:

A process in which emergency responders would have access to critical building information in the form of a model and information system. The BIM would provide critical building information to the responders that would improve the efficiency of the response and minimize the safety risks. The dynamic building information would be provided by a building automation system (BAS), while the static building information, such as floor plans and equipment schematics, would reside in a BIM model. These two systems would be integrated via a wireless connection and emergency responders would be linked to an overall system. The BIM coupled with the BAS would be able to clearly display where the emergency was located within the building, possible routes to the area, and any other harmful locations within the building.

Potential Value:

- Provide police, fire, public safety officials, and first responders access to critical building information in real-time
- Improve the effectiveness of emergency response
- Minimize risks to first responders

Resources Required:

- Design review software to view Record Model and components
- Building Automation System (BAS) linked to Record Model
- Computerized Maintenance Management System (CMMS) linked to a Record Model

Team Competencies Required:

- Ability to manipulate, navigate, and review building information model for facility updates
- Ability to understand dynamic building information through BAS
- Ability to make appropriate decisions during an emergency

Selected Resources:

- Building Information for Emergency Responders. Systemics, Cybernetics and Informatics, 11th World Multi-Conference (WMSCI 2007). Proceedings. Volume 3. Jointly with the Information Systems Analysis and Synthesis: ISAS 2007, 13th International Conference. July 8-11, 2007, Orlando, FL, Callaos, N.; Lesso, W.; Zinn, C. D.; Yang, H., Editor(s) (s), 1-6 pp, 2007. Treado, S. J.; Vinh, A.; Holmberg, D. G.; Galler, M.

- Dakhil, A., and Alshawi, M. (2014). "Client's Role in Building Disaster Management through Building Information Modelling." *Procedia Economics and Finance*, 4th International Conference on Building Resilience, Incorporating the 3rd Annual Conference of the ANDROID Disaster Resilience Network, 8th – 11th September 2014, Salford Quays, United Kingdom, 18, 47–54.
- https://ws680.nist.gov/publication/get_pdf.cfm?pub_id=903322

** referenced as 'disaster planning' in previous version of the Guide.

Appendix C: Model Use Analysis Worksheet

The following BIM Use Analysis Worksheet is available for download at [Goals and Model Use Analysis Worksheet - Version 3-0](#)

Additional details regarding the selection of BIM Uses can be found in the [BIM Uses chapter](#).

BIM Use*	Value to Project	Responsible Party	Value to Resp Party	Capability Rating			Additional Resources / Competencies Required to Implement	Notes	Proceed with Use
	High / Med / Low		High / Med / Low	Scale 1-3 (1 = Low)					YES / NO / MAYBE
				Resources	Competency	Experience			
Maintenance Scheduling									
Building Systems Analysis									
Record Modeling									
Cost Estimation									
4D Modeling									
Site Utilization Planning									
Layout Control & Planning									
3D Coordination (Construction)									
Engineering Analysis									
Site Analysis									
Design Reviews									
3D Coordination (Design)									
Existing Conditions Modeling									
Design Authoring									
Programming									

Appendix C: BIM Use Analysis Worksheet

Appendix D: Process Map Templates

The following template BIM Process Maps are available for download in multiple formats via the following links:

- [Template – Process Maps V2-0 – MS Powerpoint Format](#)
- [Template – Process Maps V2.0 – PDF Format](#)
- A Visio Template along with a Visio Stencil are available via the complete download at <http://bim.psu.edu>

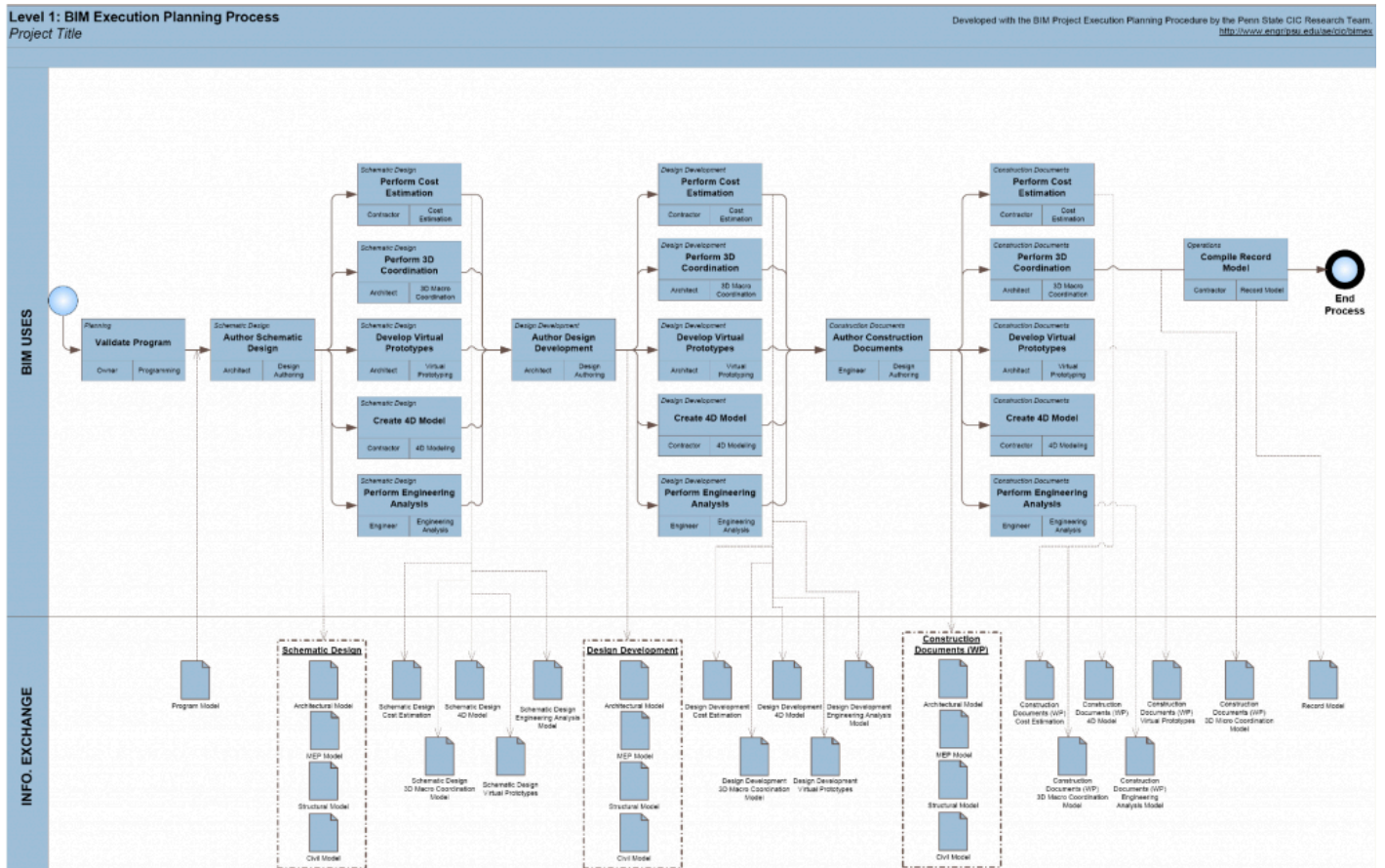

Figure D.1 – Level 1 Process Map Template

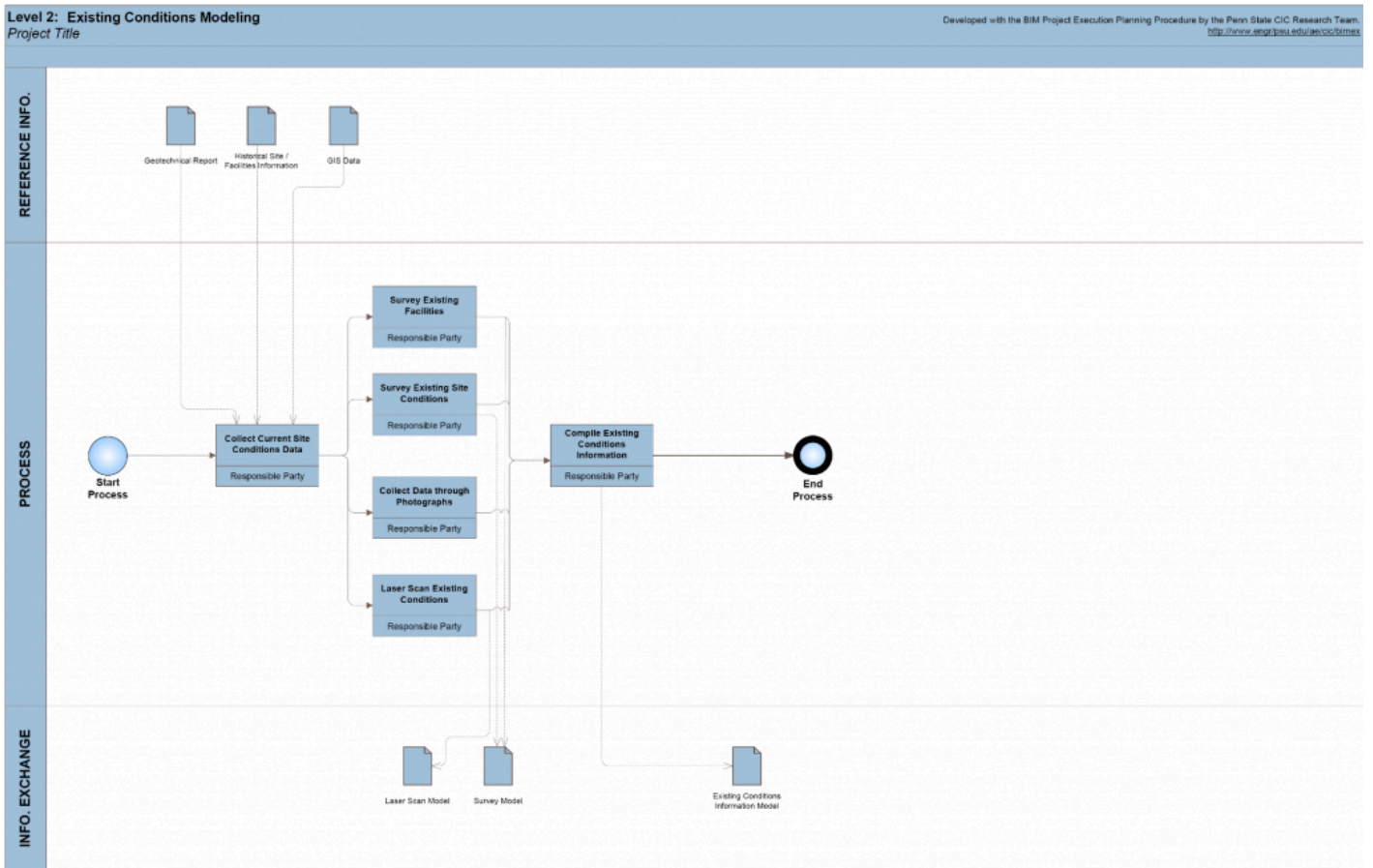

Figure D.2 – Level 2 Existing Conditions Modeling Template

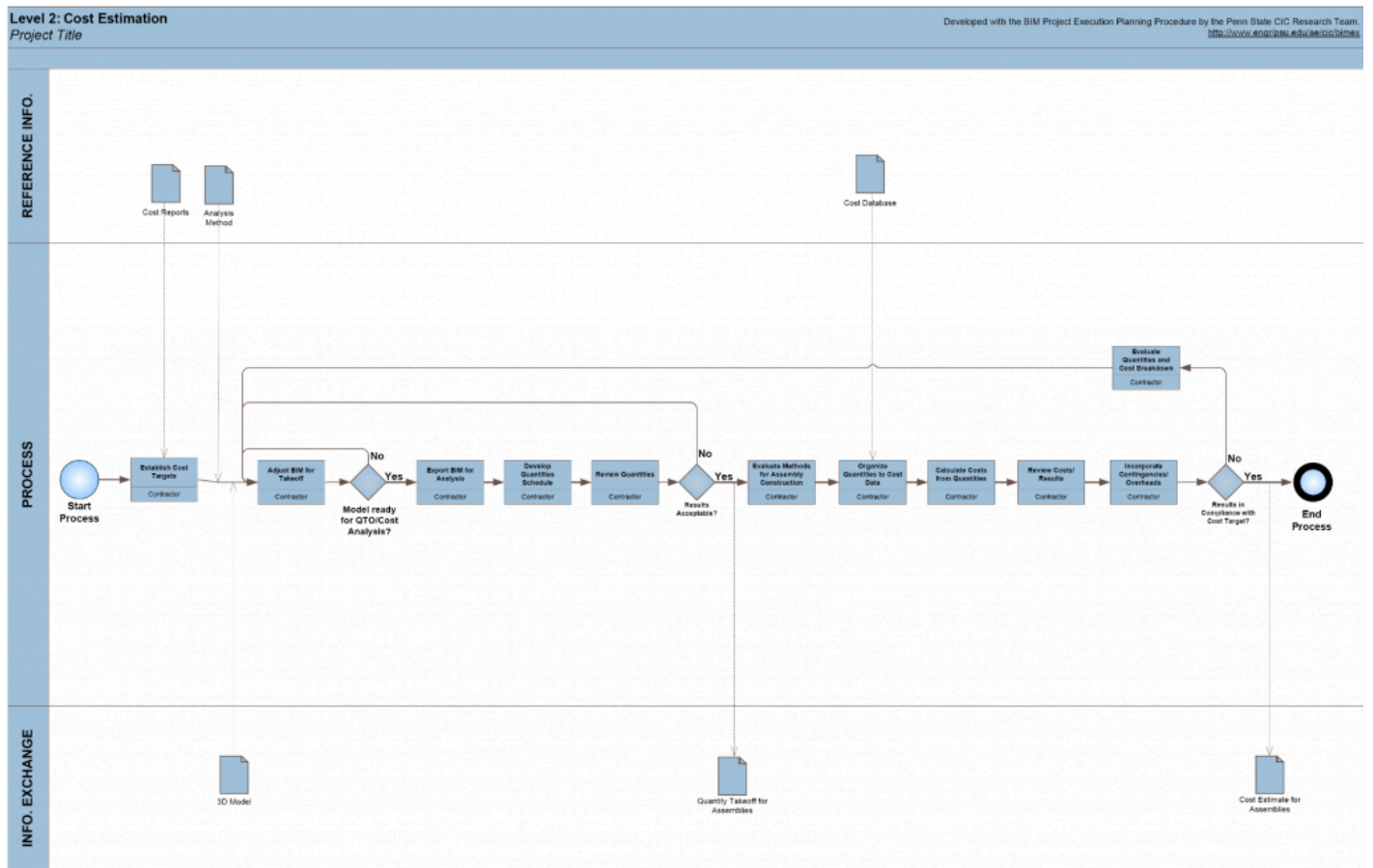

Figure D.3 – Level 2 Cost Estimation Template

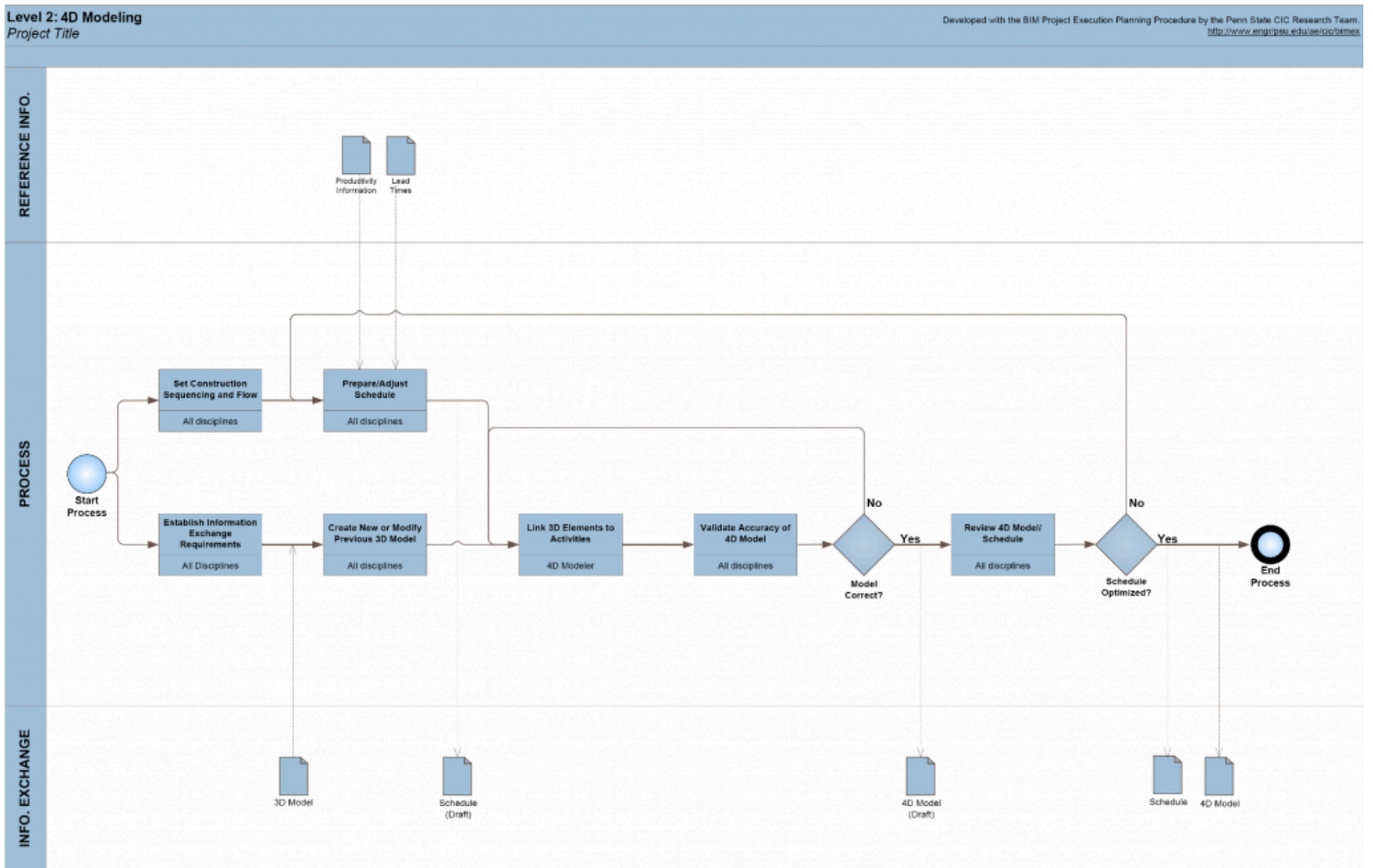

Figure D.4 – Level 2 4D Modeling Template

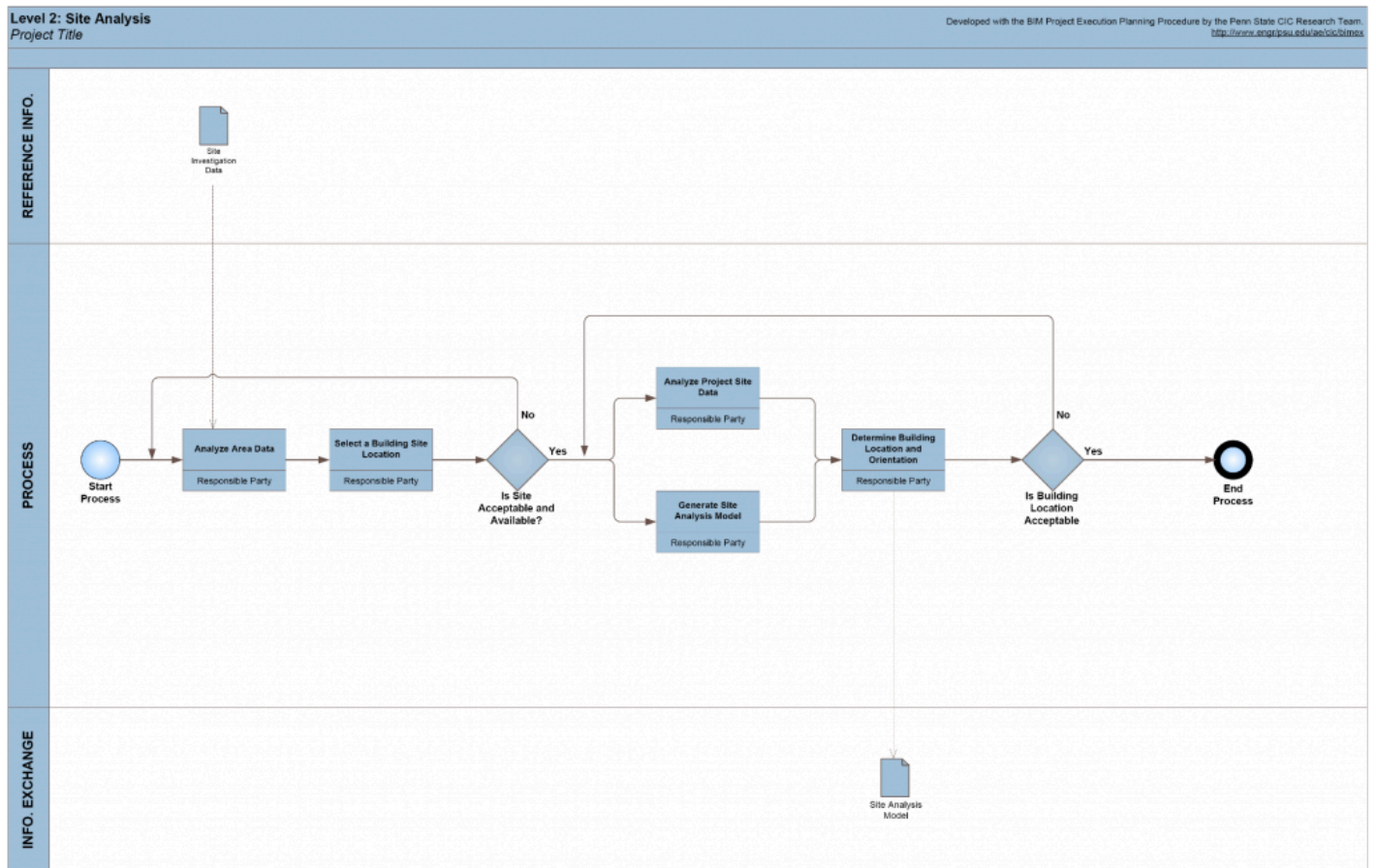

Figure D.5 – Level 2 Site Analysis Template

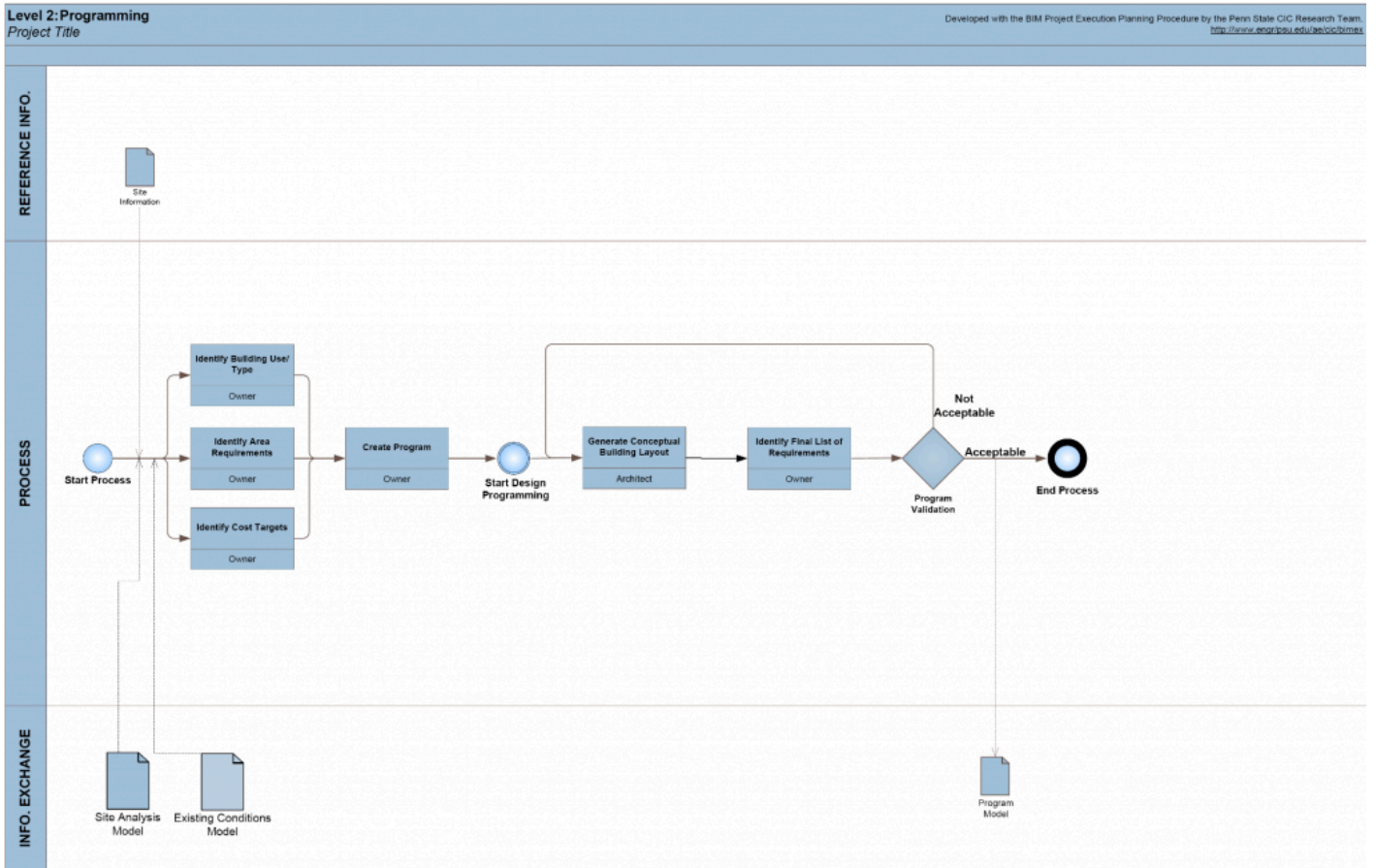

Figure D.6 – Level 2 Programming Template

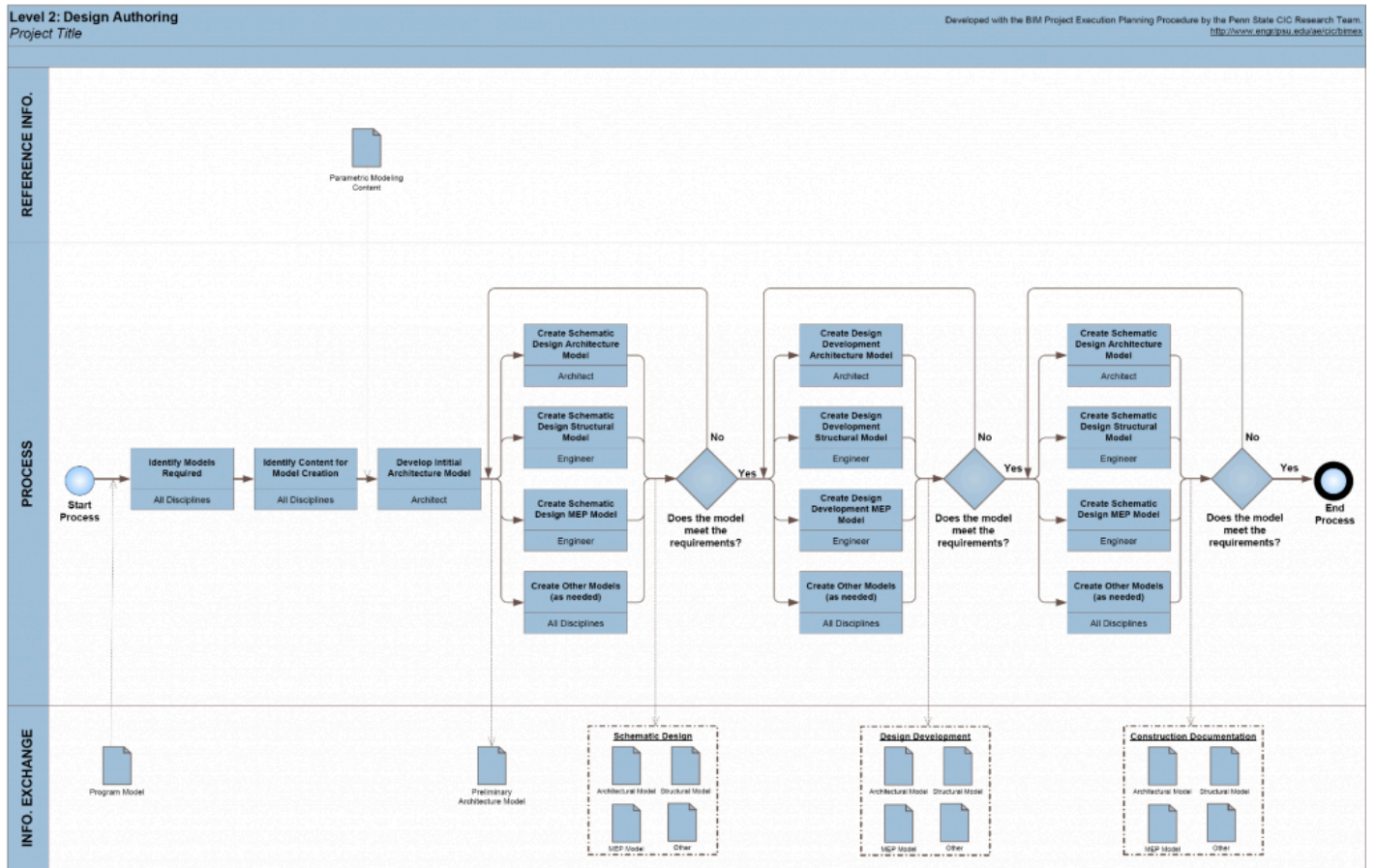

Figure D.7 – Level 2 Design Authoring Template

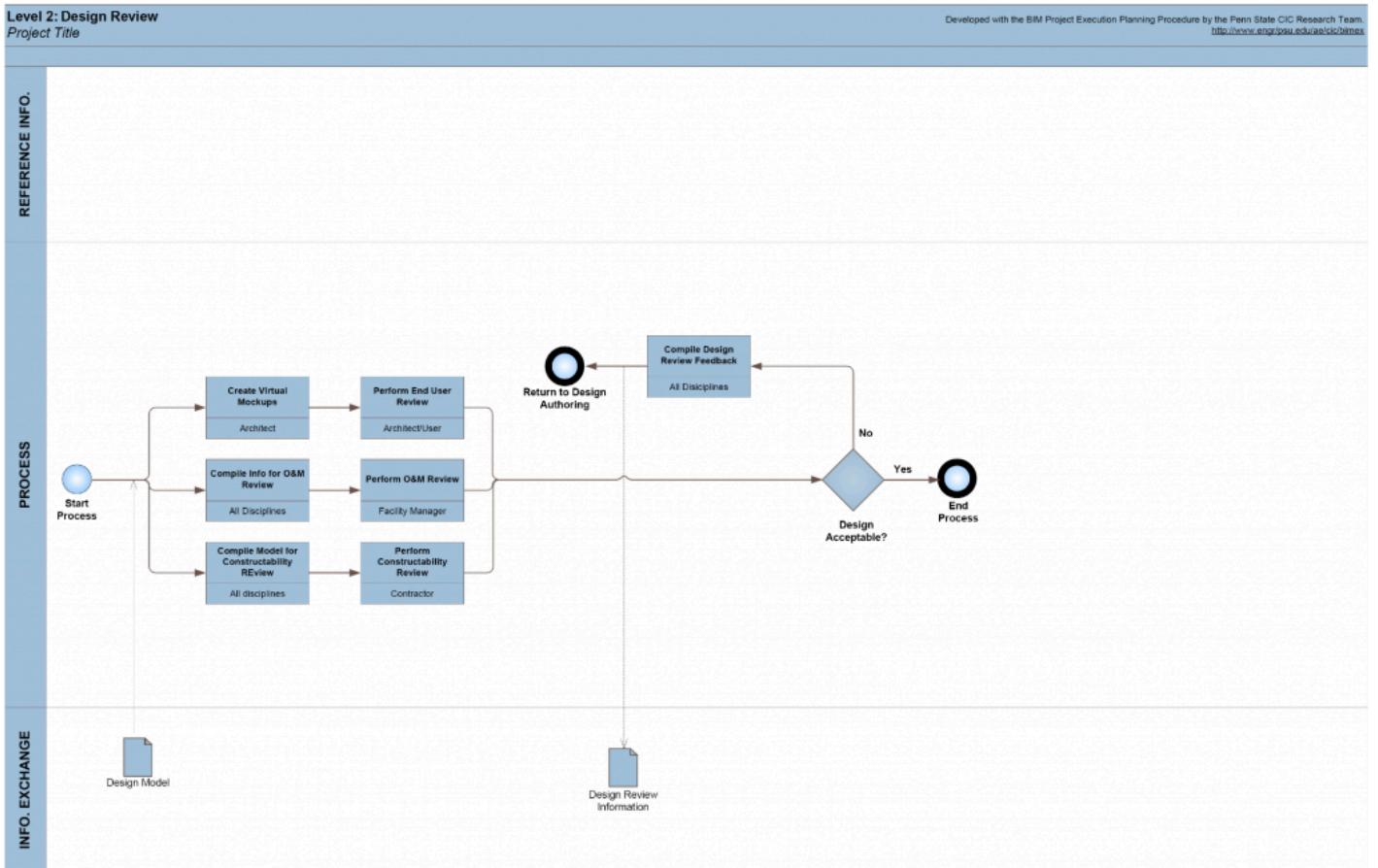

Figure D.8 – Level 2 Design Review Template

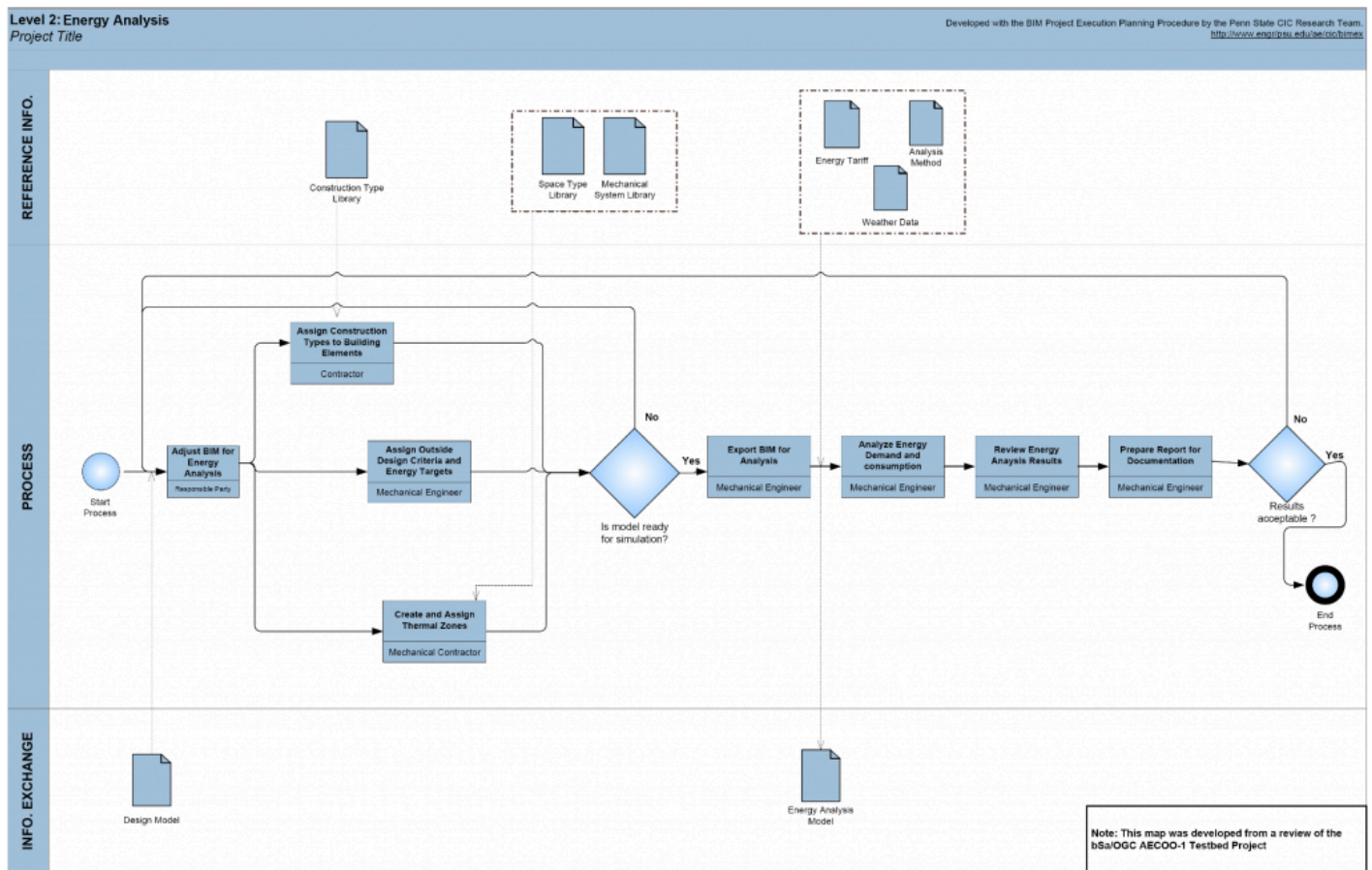

Figure D.9 – Level 2 Energy Analysis Template

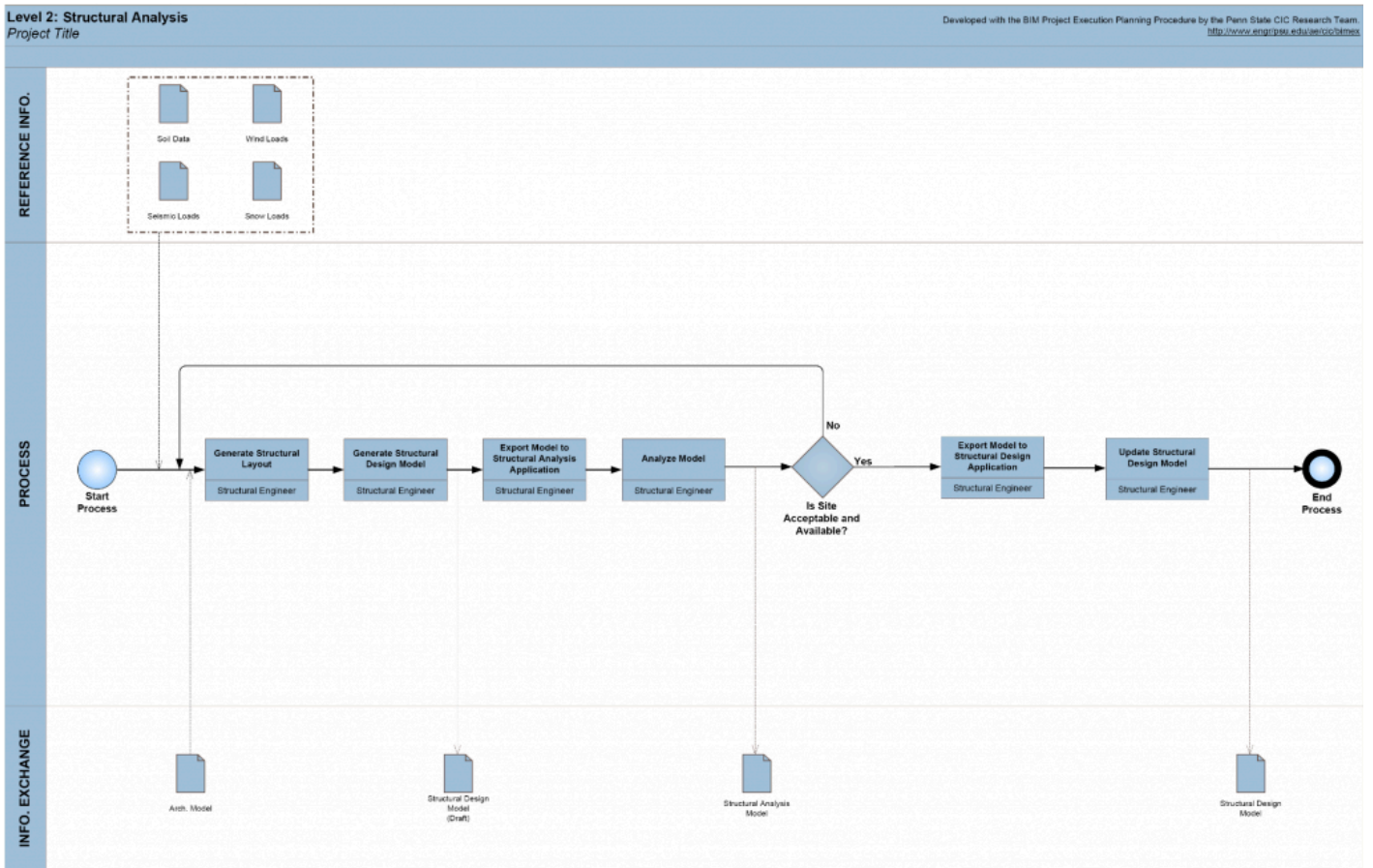

Figure D.10 – Level 2 Structural Analysis Template

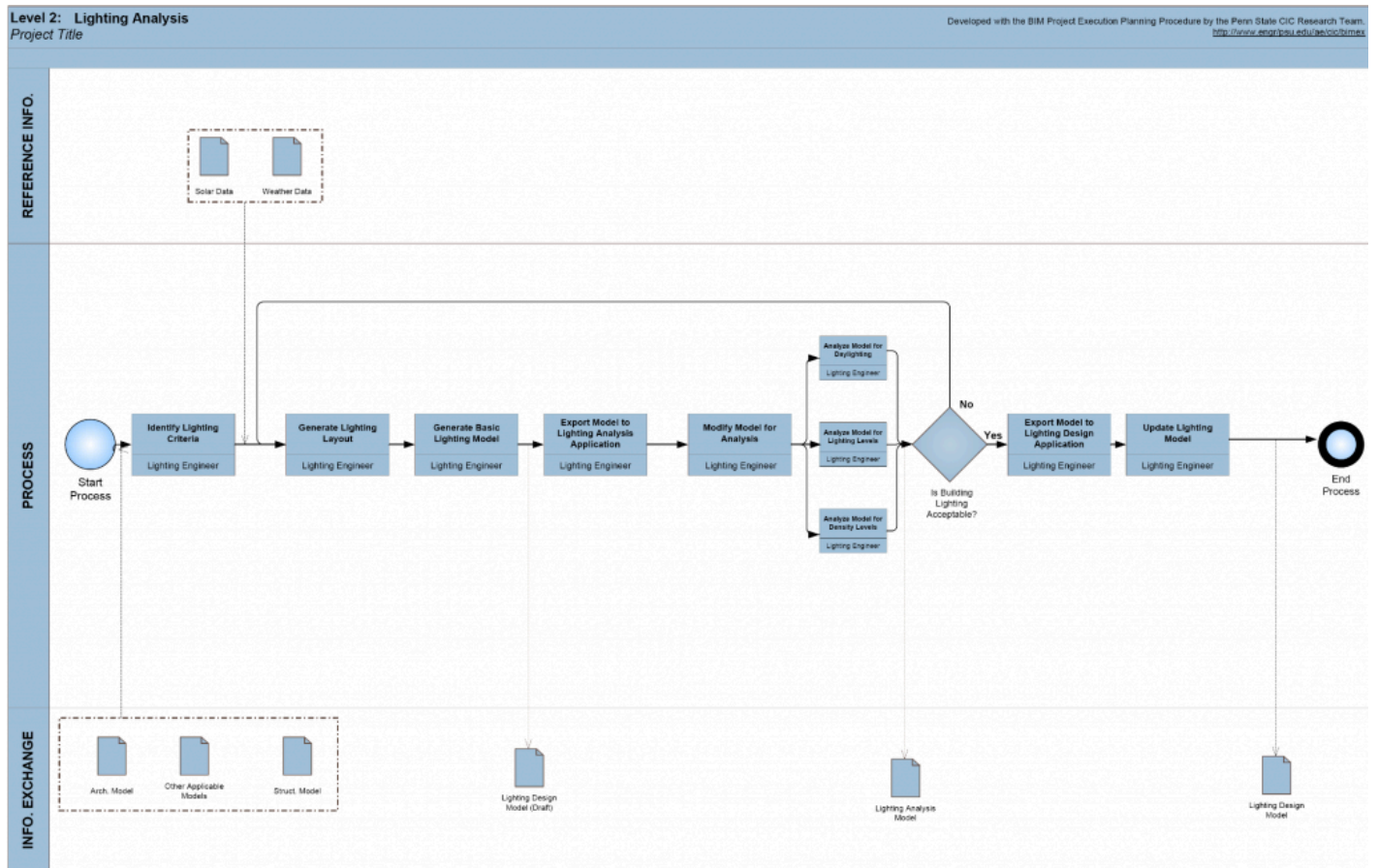

Figure D.11 – Level 2 Lighting Analysis Template

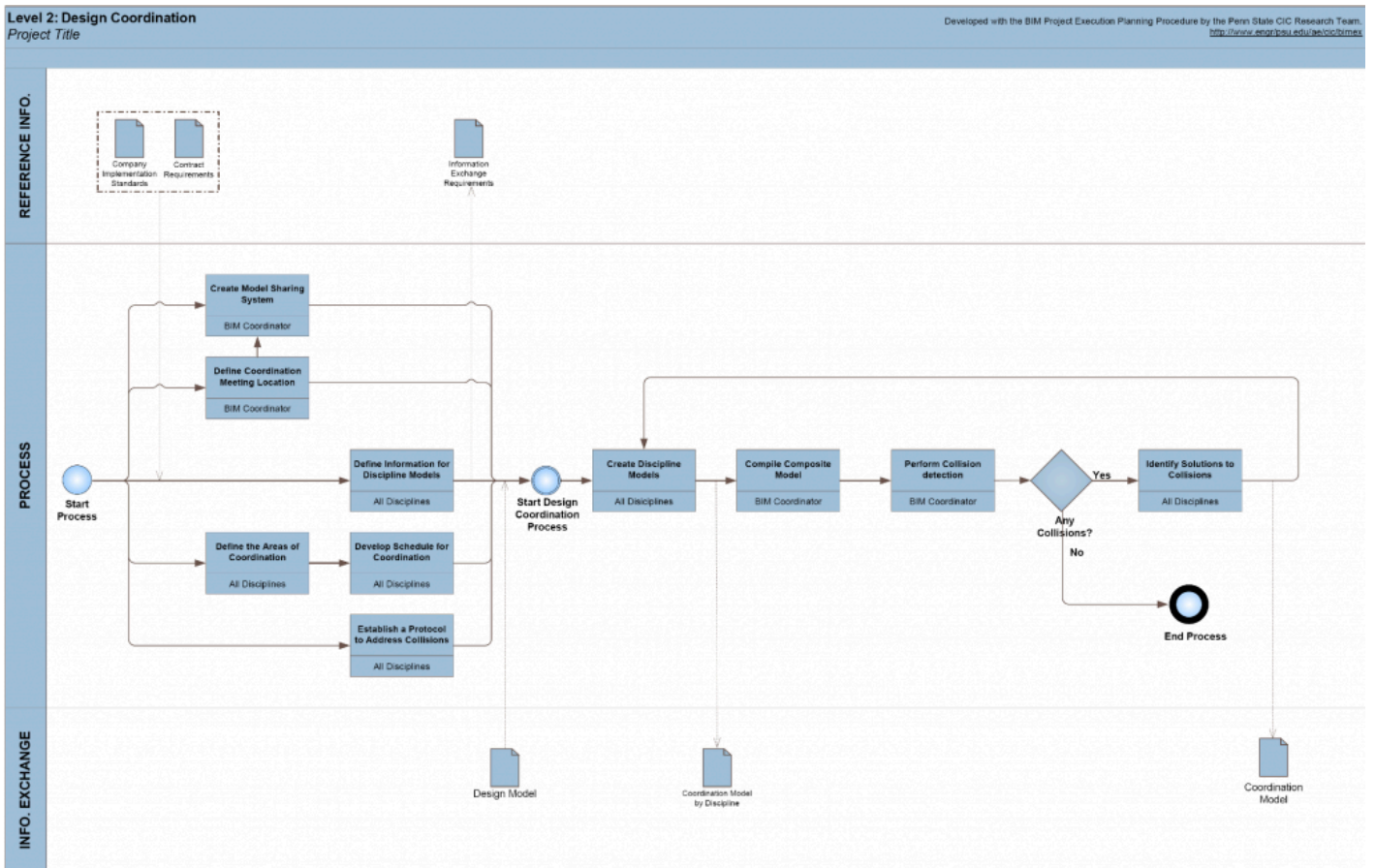

Figure D.12 – Level 2 Design Coordination Template

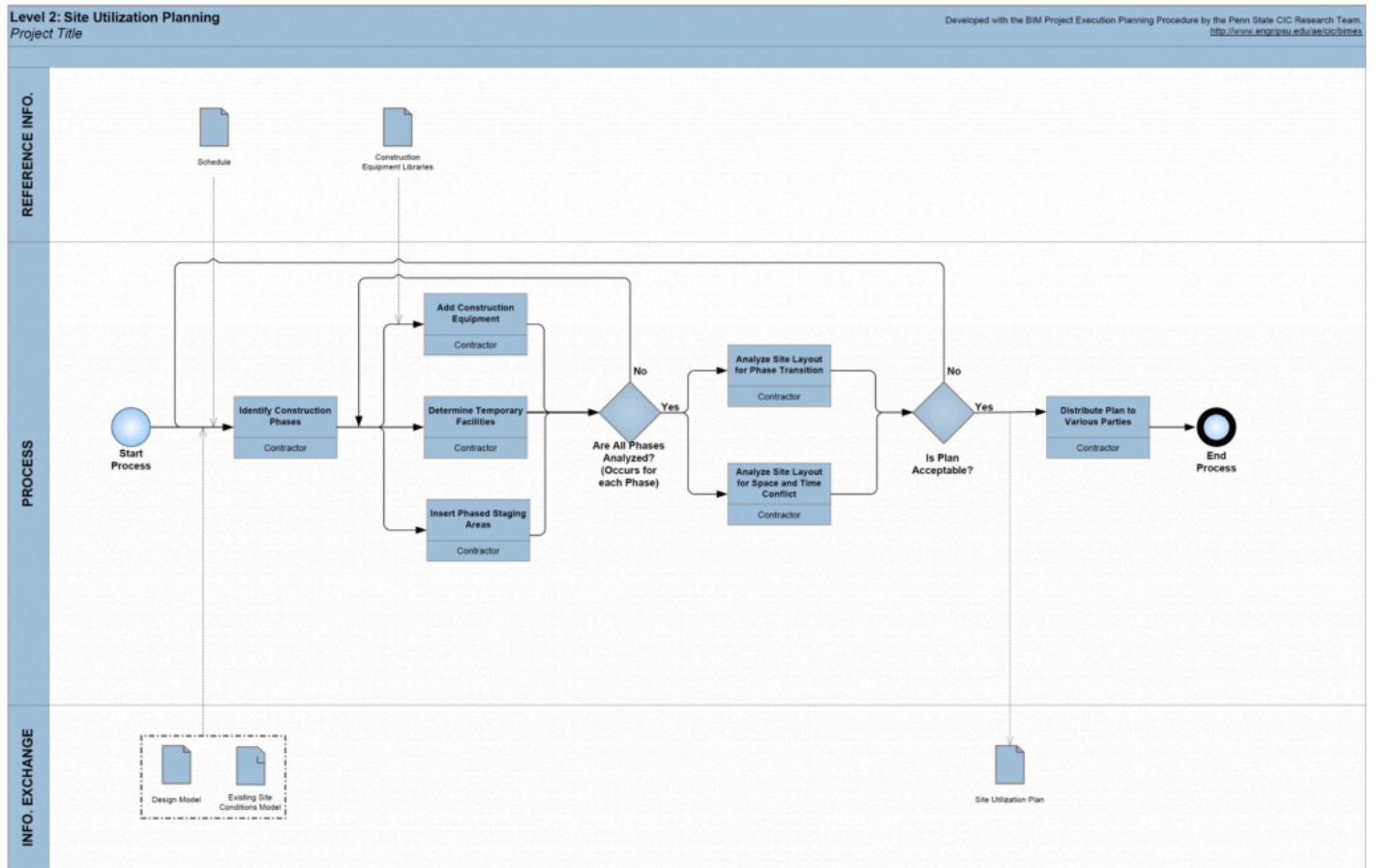

Figure D.13 – Level 2 Site Utilization Planning Template

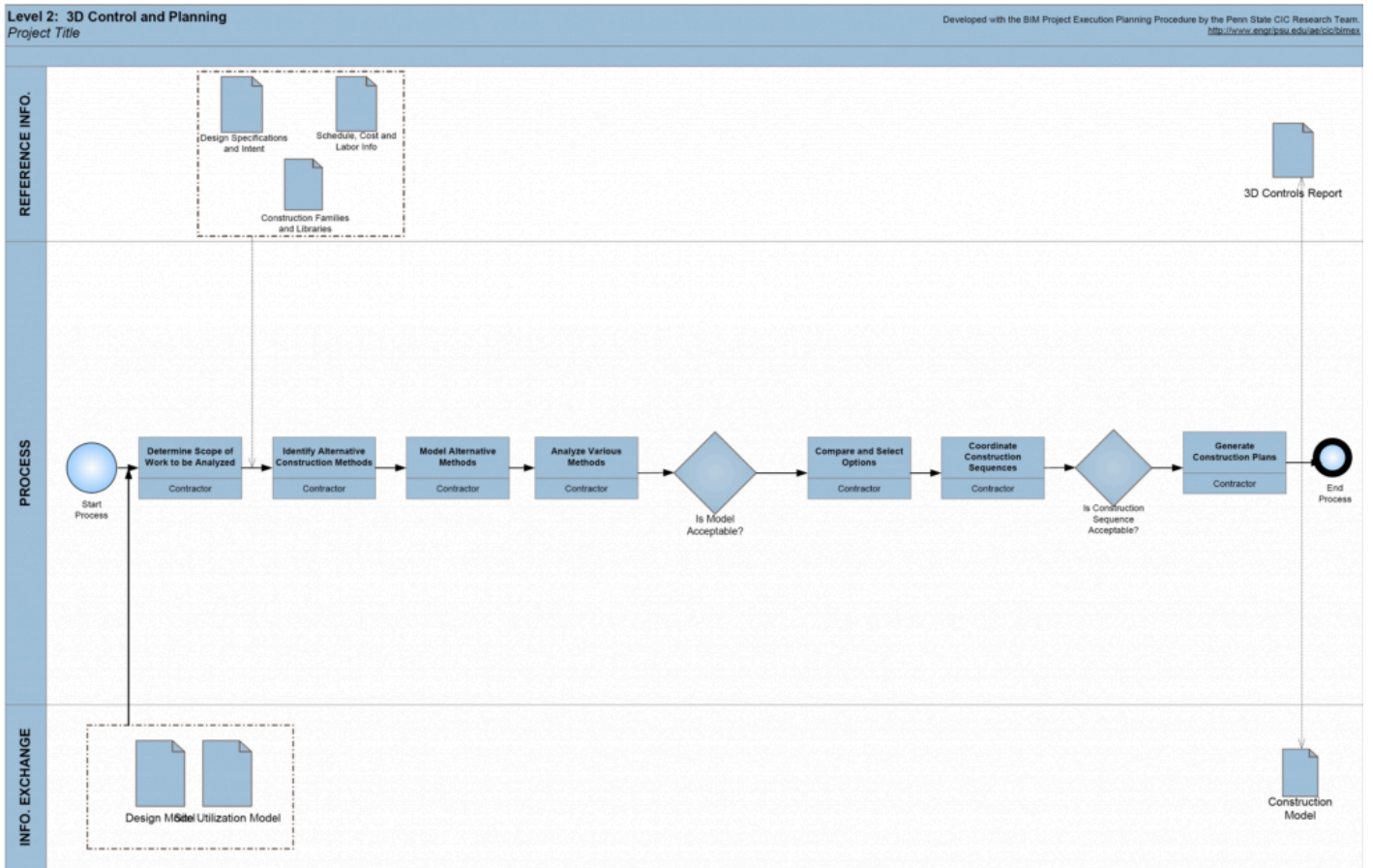

Figure D.14 – Level 2 3D Control and Planning Template

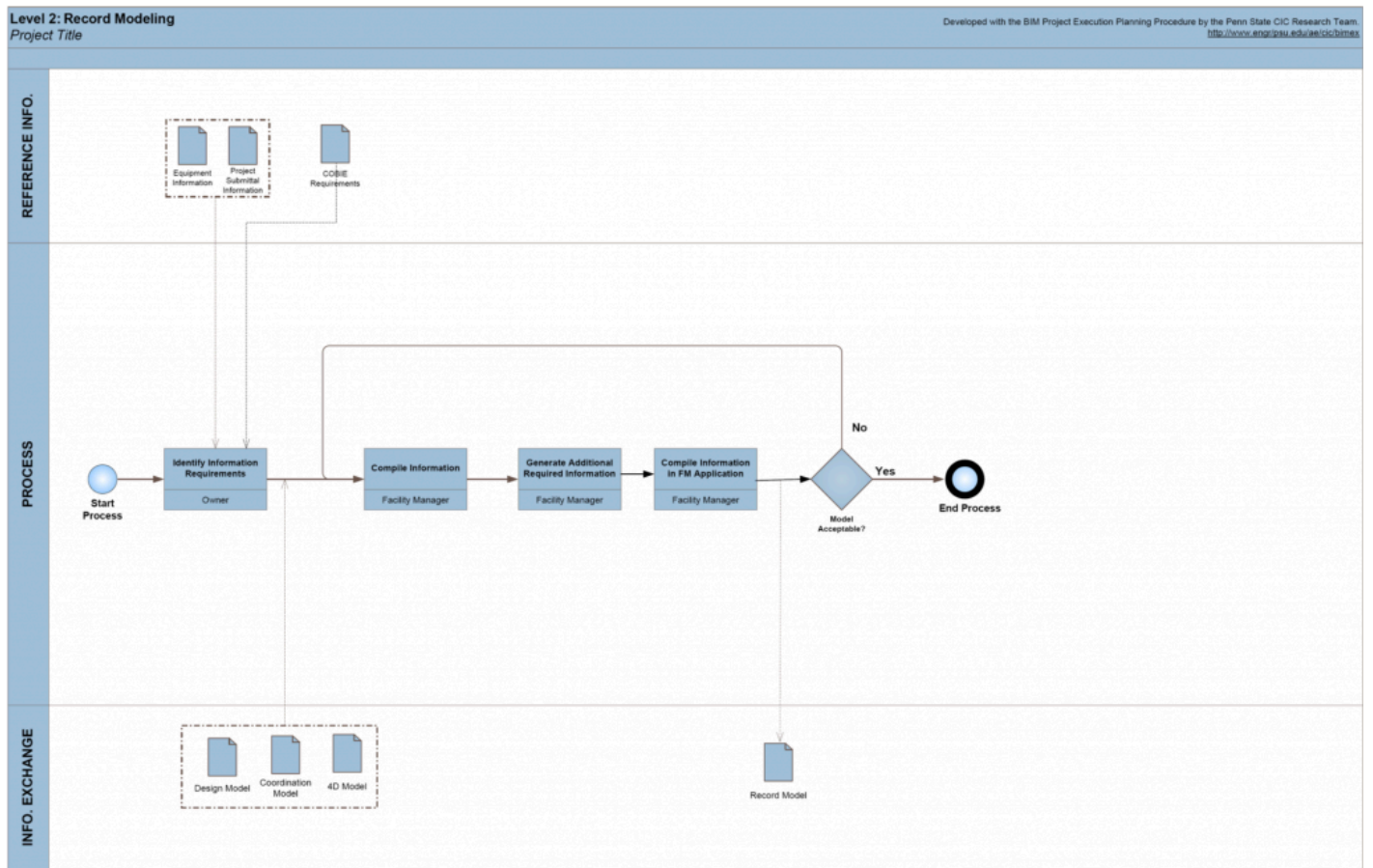

Figure D.15 – Level 2 Record Modeling Template

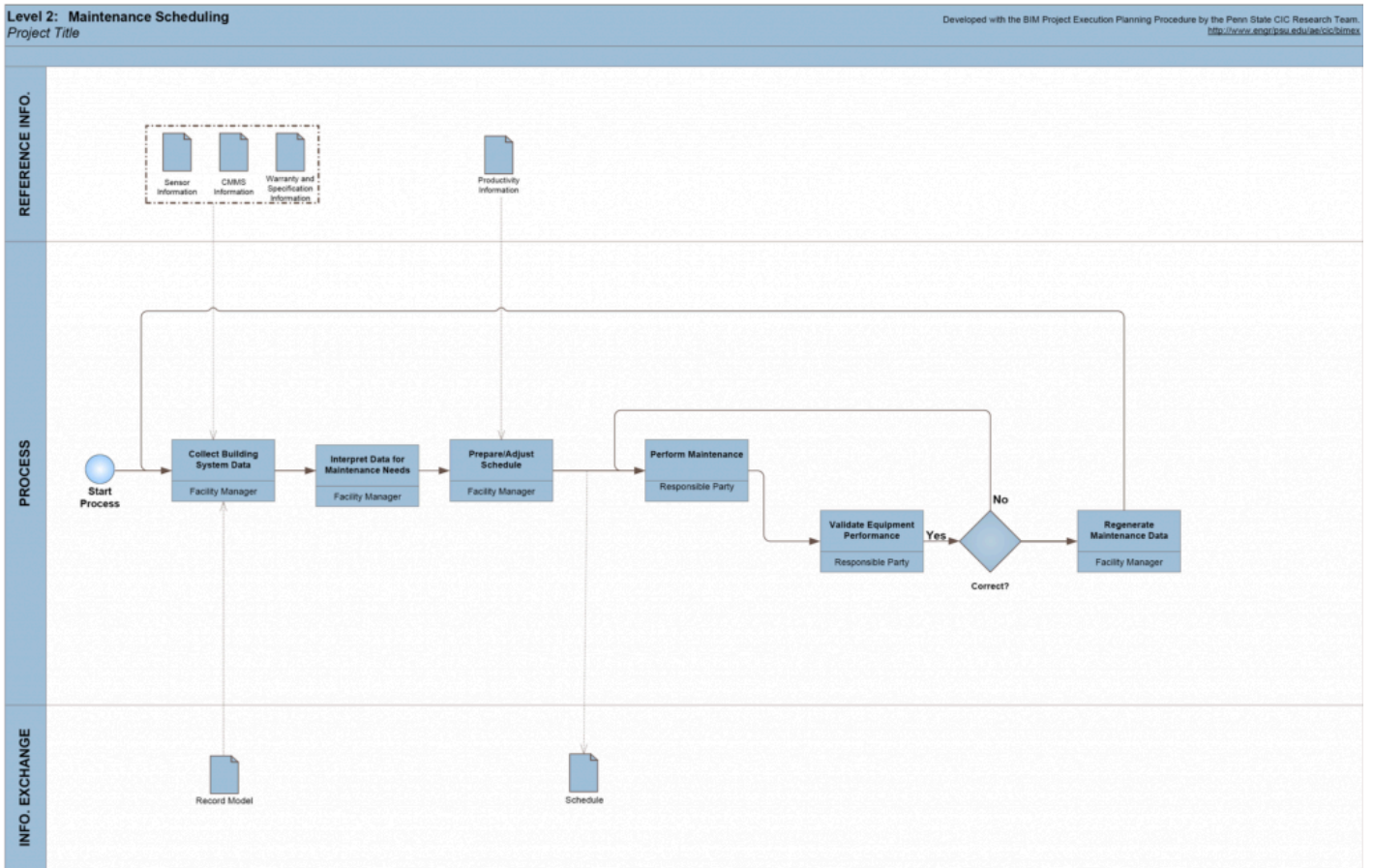

Figure D.16 – Level 2 Maintenance Scheduling Template

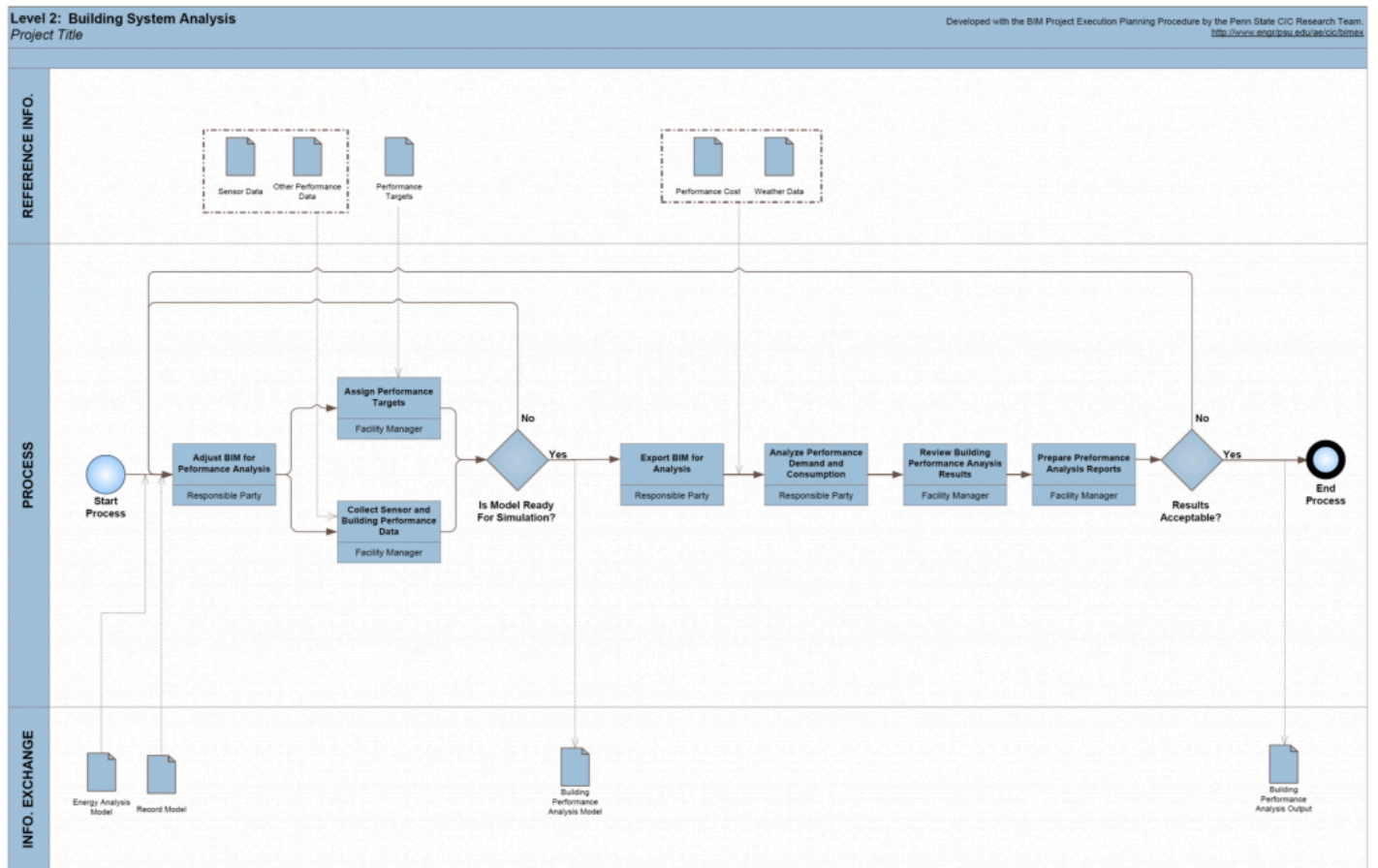

Figure D.17 – Level 2 Building System Analysis Template

Appendix E: Example Process Maps for Sample Laboratory Project

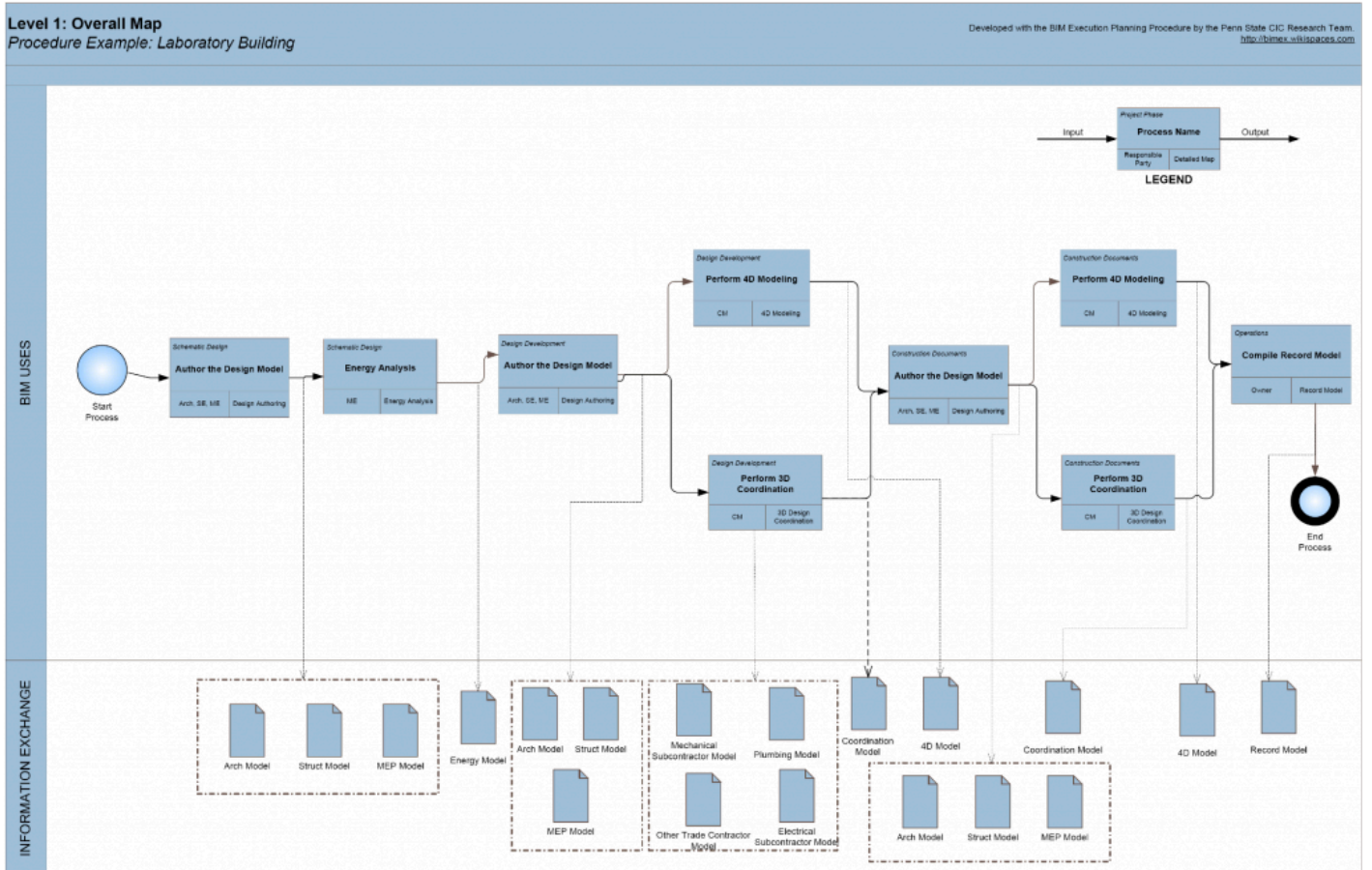

Figure E.1 – Level 1 Overall Process Map for Sample Laboratory Building Project

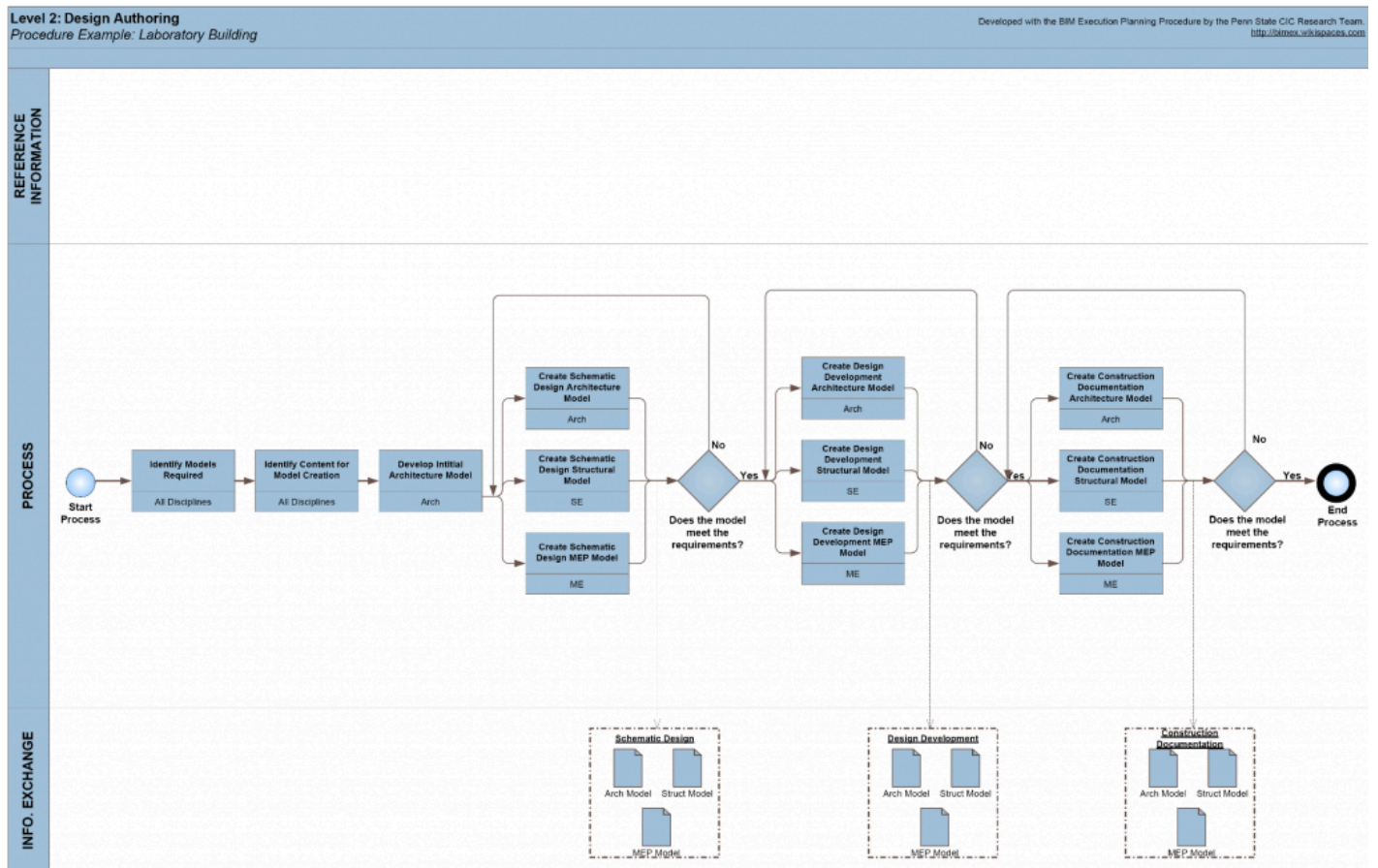

Figure E.2 – Level 2 Design Authoring for Sample Laboratory Building Project

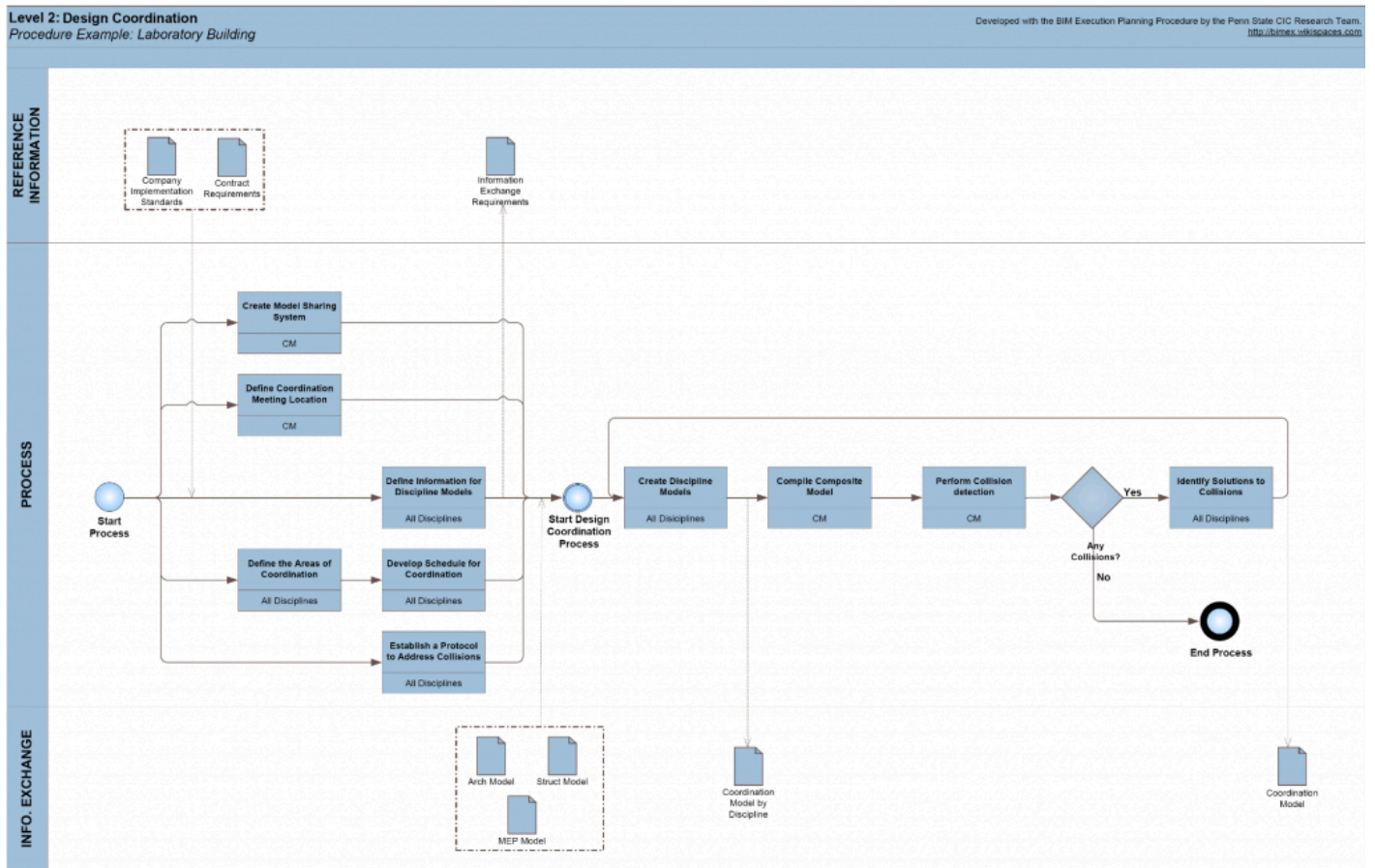

Figure E.3 – Level 2 Design Coordination for Sample Laboratory Building Project

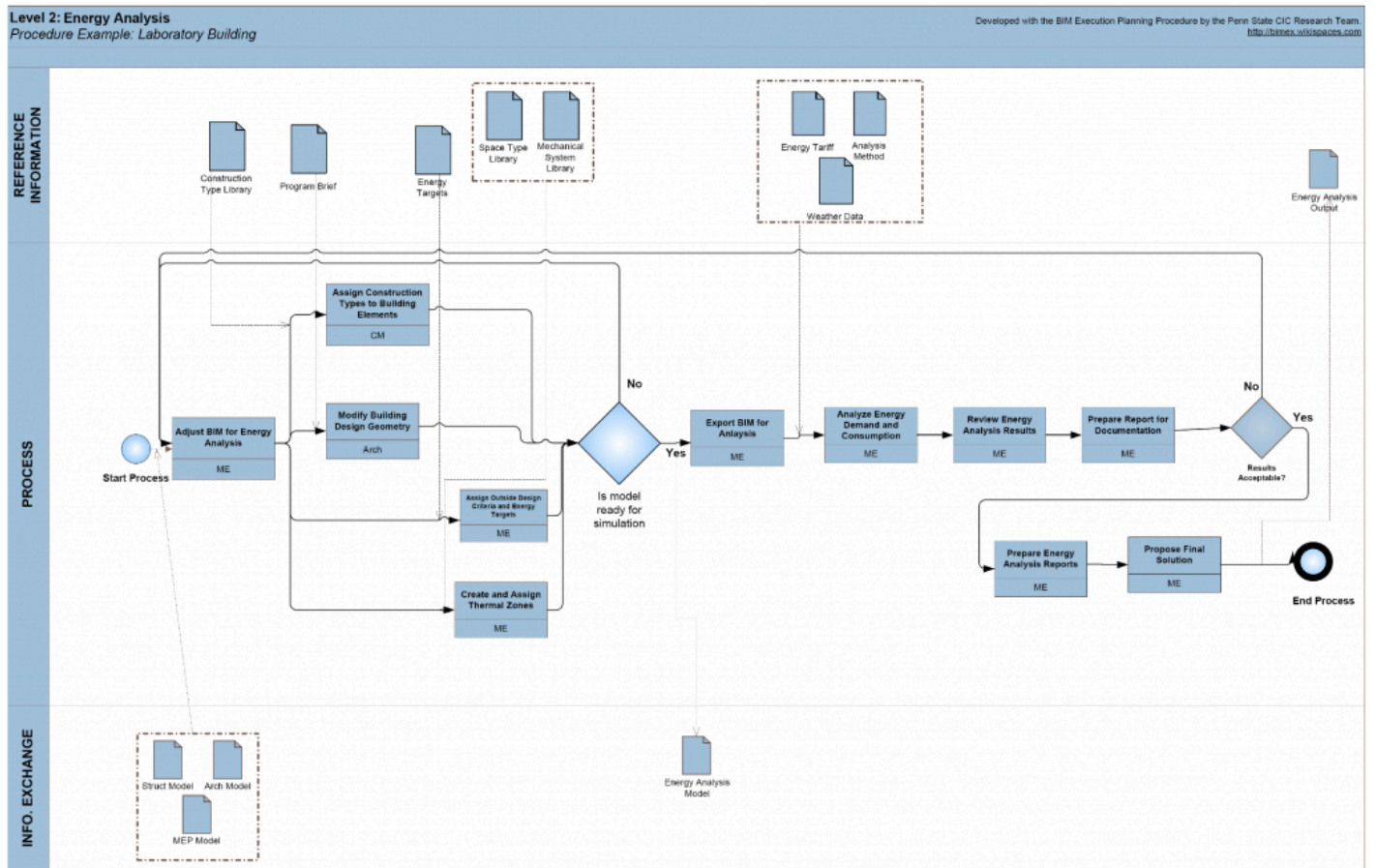

Figure E.4 – Level 2 Energy Analysis for Sample Laboratory Building Project

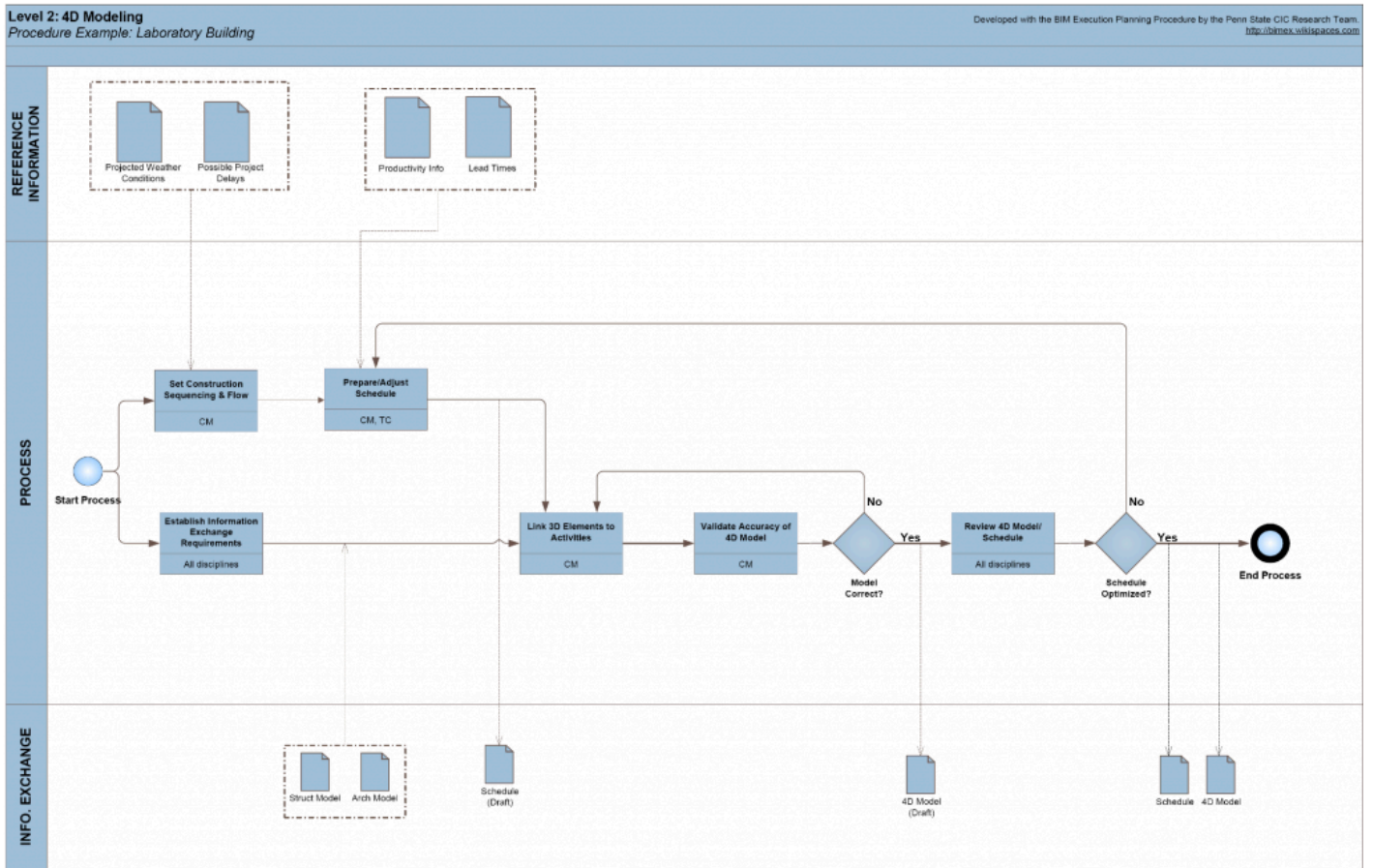

Figure E.5 – Level 2 4D Modeling for Sample Laboratory Building Project

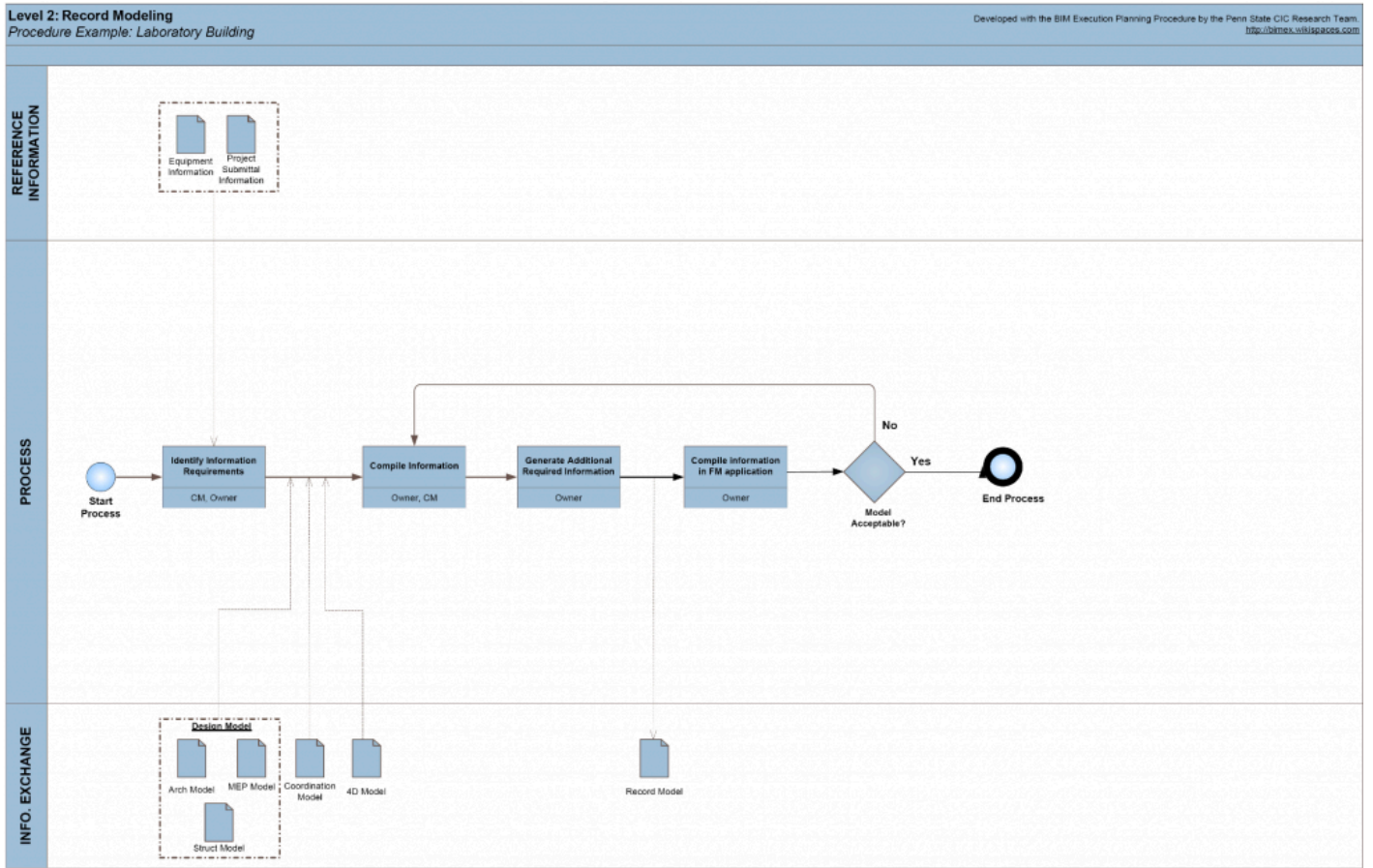

Figure E.6 – Level 2 Record Modeling for Sample Laboratory Building Project

Appendix F: Information Exchange Worksheet

The following Information Exchange Worksheet is available for download at [Template – Information Exchange Worksheet V2-1 – MS Excel Format](#).

Figure F.1 – Information Exchange Spreadsheet

Figure F.2 – Information Exchange Spreadsheet (cont.)

Appendix G: BIM Project Execution Plan Template

The complete BIM Project Execution Plan Template is available for download at [Template – BIM Project Execution Plan V2.0 – MS Word Format](#) or [Template – BIM Project Execution Plan V2.0 – PDF Format](#). The following outlines a subset of the plan template content from the initial template cover page and table of contents.

BIM PROJECT EXECUTION PLAN

VERSION 2.1

FOR

[PROJECT TITLE]

DEVELOPED BY

[AUTHOR COMPANY]

This template is a tool that is provided to assist in the development of a BIM project execution plan as required per contract. The template plan was created from the buildingSMART alliance™ (bSa) Project “BIM Project Execution Planning” as developed by the Computer Integrated Construction (CIC) Research Group at The Pennsylvania State University. The bSa project is sponsored by [The Charles Pankow Foundation](#), [Construction Industry Institute \(CII\)](#), [Penn State Office of Physical Plant \(OPP\)](#), and [The Partnership for Achieving Construction Excellence \(PACE\)](#). The BIM Project Execution Planning Guide can be downloaded at <http://bim.psu.edu>.

This cover sheet can be replaced by a company specific coversheet that includes at a minimum document title, project title, project location, author company, and project number.

This work is licensed under the Creative Commons Attribution-Share Alike 3.0 United States License. To view a copy of this license, visit <http://creativecommons.org/licenses/by-sa/3.0/us/> or send a letter to Creative Commons, 171 Second Street, Suite 300, San Francisco, California, 94105, USA.

TABLE OF CONTENTS

SECTION A: BIM PROJECT EXECUTION PLAN OVERVIEW

SECTION B: PROJECT INFORMATION

SECTION C: KEY PROJECT CONTACTS

SECTION D: PROJECT GOALS / BIM USES

SECTION E: ORGANIZATIONAL ROLES / STAFFING

SECTION F: BIM PROCESS DESIGN

SECTION G: BIM INFORMATION EXCHANGES

SECTION H: BIM AND FACILITY DATA REQUIREMENTS

SECTION I: COLLABORATION PROCEDURES

SECTION J: QUALITY CONTROL

SECTION K: TECHNOLOGICAL INFRASTRUCTURE NEEDS

SECTION L: MODEL STRUCTURE

SECTION M: PROJECT DELIVERABLES

SECTION N: DELIVERY STRATEGY / CONTRACT

SECTION O: ATTACHMENTS

Appendix H: BIM Execution Planning Category Comparison

Table H.1: BIM Execution Planning Category Comparison

BIM Execution Planning Guide	AIA BIM Protocol Ex.	Autodesk Comm. Spec.	Consensus Docs BIM Addendum	USACE BIM Roadmaps
Project Reference Information				
Project Overview Information		X		
BIM Contractual Requirements			X	
Key Project Contacts		X	X	X
Project Goals/BIM Objectives				
Purpose of BIM Implementation		X		X
Why Key BIM Use Decisions		X		X
BIM Process Design				
Process Maps for BIM Project Activities		X		
Define Information Exchanges		X		X
Delivery Strategy/Contract				
Definition of Delivery Structure		X	X	
Definition of Selection				
Definition of Contracting			X	
BIM Scope Definitions				
Model Elements by Discipline	X			
Level of Detail	X	X	X	X
Specific Model Attributes	X	X	X	X
Organizational Roles and Responsibilities				
Roles and Responsibilities of Each Organization	X	X		X
Define Contracting Strategies for Organizations			X	
Communication Procedures				
Electronic Communication Procedures		X		
Meeting Communication Procedure				
Technology Infrastructure Needs				
Hardware		X		X
Software		X	X	X
Space			X	
Networking Requirements		X		X
Model Quality Control Procedures				
Methods to ensure model accuracy	X	X	X	X
Glossary of Terms	X	X	X	X

Appendix I: Version History

Revisions from Version 1 (2009) to Version 2.0 (2011)

- Significant revisions throughout the document, including additions of content and grammatical revisions.
- Addition of examples with the Laboratory Project.

Revisions from Version 2.0 (2011) to Version 2.1 (2012)

- Revised the Level 1 BIM Process Template
- Expanded the number of template process maps in Appendix
- Added Glossary of terms
- Minor grammatical revisions

Revisions from Version 2.1 (2012) to Version 2.2 (2019)

- Revisions to the one page BIM Use descriptions contained in Appendix B
- Revised the format to web-based format using PressBooks, along with multiple downloadable options to enable easier access to individual sections
- Added links to the BIMForum Level of Development specification and the US Army Minimum Modeling Matrix to the information exchange definition chapter as potential alternatives to the information exchange template
- Enabled commenting on the published version on the website to capture suggestions for future revisions
- Published in various downloadable formats, e.g., ePub and PDF, from the online version of the Guide
- Embedded template documents via links to downloadable files to the online version of the guide to make it easier to find the template file resources. A complete list of the downloadable content was added in [Appendix J](#).
- Added Appendix I: Version History
- Grammatical revisions throughout the document
- Revised the cover page

Revisions from Version 2.2 (2019) to Version 3.0 (Draft under Development)

- Revised core planning procedure to have 5 steps, instead of the initial 4 steps in earlier versions. The initial step 1 (BIM Goals and Uses) has been separated into two steps. The first step is to establish the Project Modeling Goals and the second step is to select the Model Uses. The chapter numbers have been revised throughout the Guide and the former Chapter 2 content has been revised and distributed between Chapter 2 and Chapter 3.
- Revised and shorted chapter titles.
- Revised the term 'BIM Use' to 'Model Use' throughout the Guide. The term was revised to simplify the terminology and to limit the reference to the term 'BIM' which is not always readily accepted by project teams working on infrastructure or industrial facility projects. The term 'BIM' throughout the document has been frequently revised to either model to reference a model file or database, or modeling to refer to the process of developing or using a model. Section titles have sometimes been renamed, e.g., the Model Use Description appendices.
- Revised the list of Model Uses significantly. Many model uses were reworded to start with their core purpose as defined within [The Uses of BIM](#) document. One new model use was added (Draw Construction Documents) and several were removed from the core model uses, but a page is still included in the Appendix (Analyze Emergency Management and Analyze Engineering Performance – reworded from previous versions).
- Revised the descriptions for the model uses contained in Appendix B.

Links to Previous Versions

- [Version 1.0](#)
- [Version 2.0](#)
- [Version 2.1](#)
- [Version 2.2](#)

Appendix J: Links to All Template Documents

The following are links to all of the template documents available throughout this Guide.

- [Template – BIM Project Execution Plan V2.0 – MS Word Format](#)
- [Template – BIM Project Execution Plan V2.0 – PDF Format](#)
- [Template – Goals and Model Use Analysis Worksheet – Version 3-0](#)
- [Template – Process Maps V2-0 – MS Powerpoint Format](#)
- [Template – Process Maps V2-0 – MS Powerpoint Format](#)
- [Template – Information Exchange Worksheet V2-1 – MS Excel Format](#)

Appendix K: Citations and Sources for Additional Information

American Institute of Architects. (2008). *Model Progression Specification for BIM*. Retrieved April 20, 2009, from Integrated Project Delivery: <http://ipd-ca.net>

Autodesk. (2008). *Autodesk Communication Specifications*. San Rafael, California: Autodesk.

Fallon, K. and Palmer, M. (2007). *General Buildings Information Handover Guide: Principles, Methodology, and Case Studies*. Washington, DC: National Institute of Standards and Technology.

Larson, D. and Golden, K. (2008). *Entering the Brave New World: An Introduction to Contracting BIM*. 34.

Lowe, R. and Muncey, J. (2008). *The ConsensusDOCS 301 BIM Addendum*. Forum on the Construction industry: American Bar Association.

National Institute for Building Sciences. (2007). *National Building Information Modeling Standard – United State, Version 1, Part 1: Overview, Principles, and Methodologies*.

Perlberg, B. (2009). *ConsensusDOCS: Contracts Built by Consensus for the Project's Best Interest*. 30(1).

US Army Corps of Engineers. (2008). *BIM Road Map*. Retrieved March 17, 2008, from BIM Road Map: www.bimroadmap.com.

Appendix L: Glossary

Association (BPMN Terminology)

Used to tie information and processes with Data Objects. An arrowhead on the Association indicates a direction of flow, when appropriate.

BIM Deliverables

Information (in numerous formats) that may be required by contract or agreement to be submitted or passed to another party.

BIM Goals

Objectives used to define the potential value of BIM for a project and for project team members. BIM Goals help to define how and why BIM will be used on a project or in an organization.

BIM Process

A generic name for the practice of performing BIM. This process can be planned or unplanned. The BIM Process may also be referred to as the BIM Execution Process or the BIM Project Execution Process. The BIM Project Execution Planning Process suggests diagramming the BIM process through the use of process maps.

BIM Process Maps

a diagram of how BIM will be applied on a project. The BIM Project Execution Plan proposes two levels of Process Maps: BIM Overview Map and Detailed BIM Use Process Maps.

BIM Project Execution Plan (BEP)

The BIM Project Execution Plan (BEP) defines the goals for using BIM on the project, the model uses to be performed, the process for implementation, the information exchanges, and the overall infrastructure needed for implementation including the technology, personnel, and agreements. The BEP is focused on providing value to the project through the implementation of BIM.

BIM Project Execution Planning Procedure

A process for planning the execution of BIM on a project. It consists of four primary steps: 1) identify BIM Goals and BIM Uses, 2) design BIM Project Execution Process, 3) develop Information Exchanges, 4) define supporting infrastructure for BIM Implementation.

Building Information Model (BIM)

a digital representation of physical and functional characteristics of a facility. A BIM is a shared knowledge resource for information about a facility forming a reliable basis for decisions during its life-cycle; defined as existing from earliest conception to demolition. A basic premise of BIM is collaboration by different stakeholders at different phases of the life cycle of a facility to insert, extract, update or modify information in the BIM to support and reflect the roles of that stakeholder.

Source: National BIM Standard - US, Version 1.0

Building Information Modeling (BIM)

a process focused on the development, use, and transfer of a digital information model of a building project to improve the design, construction, and operations of a project or portfolio of facilities.

Data Object (BPMN Terminology)

A mechanism to show how data is required or produced by activities. They are connected to activities through Associations

Detailed BIM Process Map

A comprehensive BIM Process Map that defines the various sequences to perform a specific application of BIM or BIM Uses. These maps also identify the responsible parties for each process, reference information content, and the information exchanges which will be created and shared with other processes.

Event (BPMN Terminology)

An occurrence of the course of a business process. Three types of Events exist, based on when they affect the flow: Start, Intermediate, and End.

Gateway (BPMN Terminology)

Used to control the divergence and convergence of Sequence Flow. A Gateway can also be seen as equivalent to a decision in conventional flowcharting.

Group (BPMN Terminology)

A group represents a category of information. This type of grouping does not affect the Sequence Flow of the activities within the group. The category name appears on the diagram as the group label. Groups can be used for documentation or analysis purposes.

Information Exchange (IE)

Information passed from one party to another in the BIM process. The parties involved should agree upon and understand what information will be exchanged. These are often in the form of deliverables from a process that will be required as a resource for future processes.

Lane (BPMN Terminology)

A sub-partition within a Pool and will extend the entire length of the Pool, either vertically or horizontally. Lanes are used to organize and categorize activities.

Model Use

A method of applying Building Information Modeling during a facility's lifecycle to achieve one or more specific objectives.

Note: The term 'Model Use' was referred to as 'BIM Use' in previous versions of this Guide.

Overview Process Map

A high-level BIM Process Map that illustrates the relationship between BIM Uses which will be employed on the project.

Pool (BPMN Terminology)

Acts as a graphical container for partitioning a set of activities from other Pools.

Process (BPMN Terminology)

A generic term for work or activity that an entity performs and is represented by a rectangle.

Reference Information

Structured information resources (enterprise and external) that assist or are required to accomplish a BIM Use.

Sequence Flow (BPMN Terminology)

Used to show the order (predecessors and successors) that activities will be performed in a Process.